

Proračun konstrukcije obiteljske kuće

Radić, Ivan

Undergraduate thesis / Završni rad

2023

Degree Grantor / Ustanova koja je dodijelila akademski / stručni stupanj: **University of Zagreb, Faculty of Civil Engineering / Sveučilište u Zagrebu, Građevinski fakultet**

Permanent link / Trajna poveznica: <https://um.nsk.hr/um:nbn:hr:237:268450>

Rights / Prava: [In copyright](#)/[Zaštićeno autorskim pravom.](#)

Download date / Datum preuzimanja: **2025-02-20**

Repository / Repozitorij:

[Repository of the Faculty of Civil Engineering,
University of Zagreb](#)



SVEUČILIŠTE U ZAGREBU

GRAĐEVINSKI FAKULTET

IVAN RADIĆ

PRORAČUN KONSTRUKCIJE

OBITELJSKE KUĆE

ZAVRŠNI RAD

Zagreb, 2023.

SVEUČILIŠTE U ZAGREBU

GRAĐEVINSKI FAKULTET

**PRORAČUN KONSTRUKCIJE
OBITELJSKE KUĆE**

ZAVRŠNI RAD

Student: Ivan Radić

Mentor: prof.dr.sc. Mladen Meštrović

Zagreb, 2023.

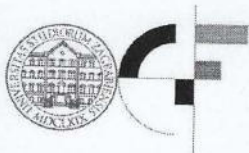

TEMA ZAVRŠNOG ISPITA

Ime i prezime studenta:

JMBAG:

Završni ispit iz predmeta:

Naslov teme završnog ispita:	HR	Proračun konstrukcije obiteljske kuće
	ENG	Structural analysis of one-family house

Opis teme završnog ispita:

definirati konstrukciju, analiza opterećenja, numerički model konstrukcije, proračun unutarnjih sila, dimenzioniranje konstrukcije, nacrt armature karakterističnih elemenata konstrukcije

Datum:

Komentor:
(Ime i prezime komentora)

Mentor:
(Ime i prezime mentora)

(Potpis mentora)

Sadržaj

1. Tehnički opis konstrukcije	1
1.1. Općenito	1
1.2. Nosivi zidovi	1
2. Opterećenja na konstrukciju:	3
2.1. Vlastita težina	3
2.2. Dodatno stalno opterećenje	3
2.3. Uporabno opterećenje.....	6
2.4. Opterećenje snijegom	6
2.5. Opterećenje vjetrom	9
2.6. Potresno opterećenje.....	11
3. Analiza numeričkog modela.....	16
3.1. Prikaz numeričkog modela	16
3.2. Prikaz maksimalnog progiba ploče (2.kombinacija)	17
3.3. Prikaz momenta M_{11}	18
3.4. Prikaz momenta M_{22}	20
3.5. Prikaz potrebne armature.....	22
3.6. Prikaz reakcija	24
4. Proračun zidova.....	25
4.1. Općenito	25
4.2. Prikaz sila i proračun zidova (X smjer):.....	30
4.3. Prikaz sila i proračun zidova (Y smjer):.....	37
5. Prilozi	44
Literatura	45

Sažetak: Proračun konstrukcije obiteljske kuće

Tema ovog završnog rada je izrada numeričkog modela te proračun i dimenzioniranje zidane konstrukcije obiteljske kuće. Analizirana su opterećenja za predmetnu građevinu te je u skladu sa europskim normama proveden proračun. Numerički model izrađen je u programu ETABS 18, iz kojeg su dobivene vrijednosti za proračun i dimenzioniranje. Konstrukcija se nalazi na potresnom području te je dimenzionirana na potresno djelovanje. Izrađeni su armaturni planovi za međukatnu konstrukciju prema dobivenim vrijednostima.

Ključne riječi: konstrukcija, proračun, dimenzioniranje, potres, numerički model

Abstract: Structural analysis of a family house

The topic of this final thesis is the creation of a numerical model, calculation and structural design of the masonry construction of a family house. The loads for the location were analyzed and a calculation was carried out in accordance with European standards. The numerical model was created in the ETABS 18 software, from which the values for calculation and design were obtained. The structure is located in an earthquake zone and is designed for earthquake resistance. Reinforcement plans for floor construction were made according to the obtained values.

Keywords: construction, calculation, structural design, earthquake, numerical model

1. Tehnički opis konstrukcije

1.1. Općenito

Izrađen je numerički model te proračun obiteljske kuće smještene u Solinu. Građevina se sastoji od dvije etaže, prizemlja visine 2,70 m i kata visine 2,70 m. Nosivi zidovi izvedeni su od opeke debljine 25 cm, zidane vapneno - cementnim mortom. Međukatna konstrukcija izvedena je kao AB ploča debljine 16 cm. Zidovi su ojačani horizontalnim i vertikalnim serklažima. Tlocrtne dimenzije građevine su 13.70 m x 9.20 m. Vertikalna povezanost kata s prizemljem omogućeno je AB stubištem. Krov je izveden kao ravni krov, s AB pločom debljine 16 cm.

1.2. Konstrukcija

Nosivi zidovi zidani su od blok opeke Porotherm 25 Profi, vapneno – cementnim mortom marke M10. Zidovi su debljine $t = 25$ cm, te su omeđeni horizontalnim i vertikalnim serklažima.

TEHNIČKE KARAKTERISTIKE		
Dimenzije		37,5x25x24,9 cm
Debljina zida	d	25 cm
NF		11,97
Masa	m	17,6 kg/kom
Potrošnja opeke m ²		10,67 kom/m ²
Potrošnja opeke m ³		42,7 kom/m ³
Utrošak tankoslojnog morta		2,5 // 10 l/m ² // l/m ³
Utrošak DRYFIX.extra		6 m ² /doza
m ² od m ³ opeke		4 m ²
Težina m ² zida (tankoslojni/DRYFIX.extra)		1,91 // 1,88 kN/m ²
Težina m ³ zida (tankoslojni/DRYFIX.extra)		7,64 // 7,52 kN/m ³
MEHANIČKE KARAKTERISTIKE		
Tlačna čvrstoća	f _b	10 N/mm ²
Karakteristična tlačna čvrstoća zida (tankoslojni/DRYFIX.extra)	f _k	4,52 // 3,75 N/mm ²

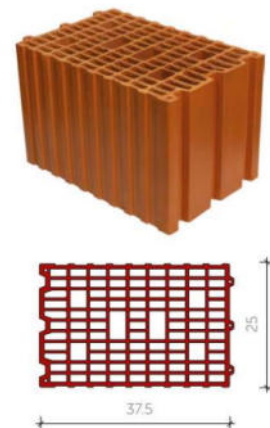

Slika 1.1. : Prikaz karakteristika bloka

Vrste mortova	Minimalna tlačna čvrstoća nakon 28 dana (N/mm ²)	Približni sastav		
		cement	hidratizirano vapno	pijesak
M20	20	treba odrediti ispitivanjem		
M15	15	1	0-1/4	3
M10	10	1	1/4 - 1/2	4 - 4 1/4
M5	5	1	1/2 - 1 1/4	5-6
M2,5	2.5	1	1 1/4 - 2 1/2	8-9
M1	1	1	nije definirano	>9

Tablica 1.2. : Karakteristike i sastav morta

Serklaži su izvedeni od betona C25/30 te su armirani armaturom B-500. Vertikalni serklaži dimenzija 25x25 cm a Horizontalni serklaži su dimenzija 25x40 cm. Serklaži su izvedeni nakon zidanja.

2. Opterećenja na konstrukciju:

2.1. Vlastita težina

Vlastita težina nosivih dijelova konstrukcije programski paket automatski uzima u proračun u slučaju opterećenja DEAD.

2.2. Dodatno stalno opterećenje



Slika 2.1. : Presjek međukatne konstrukcije

Međukatna konstrukcija:

Sloj	Debljina sloja [m]:	γ [kN/m ³]	$d \times \gamma$ [kN/m ³]
Završni sloj poda	0,02	8	0,16
Cementni estrih	0,05	22	1,1
PE folija	-	-	-
Toplinska izolacija	0,03	2	0,06
AB ploča	0,16	25	-
Žbuka	0,02	18	0,36
UKUPNO:			1,68

Tablica 2.2. : Dodatno stalno opterećenje međukatne konstrukcije

Opterećenje od slojeva poda ne uključuje težinu AB ploče.

U dodatno stalno opterećenje također spadaju i težina instalacija, pregradnih zidova i ostalih tereta. Za njihovu težinu je uzeta vrijednost od 1 kN/m^2 .

Ukupna težina od slojeva međukatne konstrukcije i dodatnog tereta tada iznosi: $2,68 \text{ kN/m}^3$.

Ravni krov:

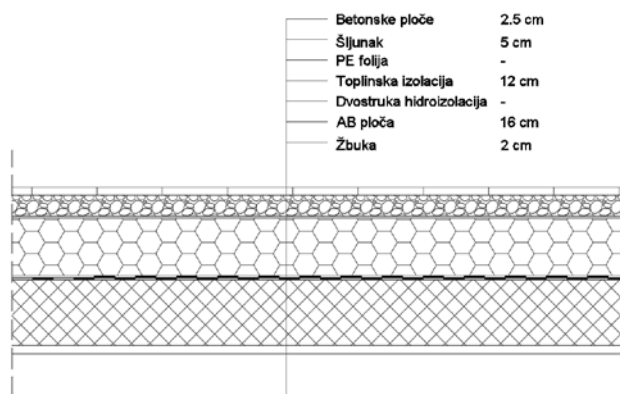

Slika 2.3. : Presjek ravnog krova

Sloj	Debljina sloja [m]:	γ [kN/m ³]	$d \times \gamma$ [kN/m ²]
Betonske ploče	0,025	22	0,55
Šljunak	0,05	18	0,9
PE folija	-	-	-
Toplinska izolacija	0,12	0,3	0,036
Hidroizolacija	-	-	-
AB ploča	0,16	25	-
Žbuka	0,02	18	0,36
UKUPNO:		$\Delta g =$	1,846

Tablica 2.4. : Dodatno stalno opterećenje ravnog krov

Stubište:

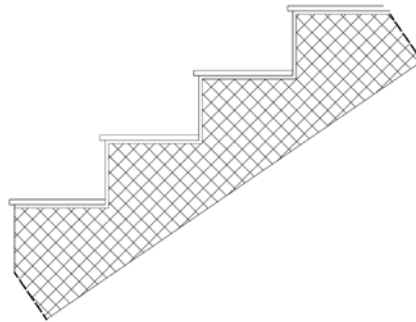

Slika 2.5. : Presjek stubišta

Sloj	Debljina sloja [m]:	γ [kN/m ³]	$d \times \gamma$ [kN/m ³]
Kamena pločica	0,02	25	0,50
Cementni namaz	0,01	22	0,22
Stuba	0,08	24	1,92
AB ploča	0,16	25	-
Žbuka	0,02	18	0,36
UKUPNO:		$\Delta g =$	3,00

Tablica 2.6. : Dodatno stalno opterećenje stubišta

2.3. Uporabno opterećenje

Uporabno opterećenje uzeto prema važećim propisima (2,00 kN/m² za međukatne konstrukcije, 3,00 kN/m² za stubište, 4,00 kN/m² za balkone).

		q _k (kN/m ²)	Q _k (kN/m ²)
A	Stambene prostorije, odjeli u bolnicama, hotelske sobe		
	uobičajene prostorije	2,0	2,0
	stubišta	3,0	2,0
	balkoni	4,0	2,0

Tablica 2.7. : Vrijednosti uporabnog opterećenja

2.4. Opterećenje snijegom

Opterećenje snijegom računa se na osnovi karakterističnog opterećenja s_k , koje odgovara jednolikom snijegu koji je napadao pri mirnim vremenskim uvjetima na ravno tlo. Ova se vrijednost prilagođava ovisno o obliku krova, njegovim toplinskim karakteristikama, hrapavosti površine, količini topline koja se skuplja ispod krova, blizini susjednih zgrada, okolnom terenu te lokalnim meteorološkim karakteristikama.

Opterećenje snijegom na krov određuje se izrazom:

$$s = \mu_i \cdot C_e \cdot C_t \cdot s_k$$

s_k → karakteristična vrijednost opterećenja od snijega na tlo [kN / m²]

μ_i → koeficijent oblika opterećenja snijegom

C_e → koeficijent izloženosti (obično 1,0)

C_t → toplinski koeficijent (obično 1,0)



Za predmetnu građevinu uzeti su koeficijenti:

Koeficijent izloženosti $C_e = 1,0$

Toplinski koeficijent $C_t = 1,0$

Koeficijent oblika opterećenja snijegom $\mu_i = 0,8$

Karakteristična vrijednost opterećenja od snijega na tlo (kN/m^3) $s_k = 0,45$

Zona 3 ispod 100 m

Opterećenje od snijega na krovnu konstrukciju:

$$s = 0,8 \cdot 1,0 \cdot 1,0 \cdot 0,45$$

$$s = 0,36 \left[\text{kN} / \text{m}^2 \right]$$



Nadmorska visina do (m)	A područje	B područje	C područje	D područje
100	1,10	1,10	0,45	0,35
200	1,30	1,40	0,80	0,50
300	1,55	1,75	1,20	0,70
400	1,80	2,20	1,65	0,90
500	2,05	2,65	2,15	1,15
600	2,35	3,15	2,70	
700	2,65	3,70	3,30	
800	2,95	4,25	3,95	
900	3,25	4,90	4,65	
1000	3,60	5,55	5,40	
1100	3,95	6,25	6,20	
1200	4,30	7,00	7,05	
1300	--	7,80	7,95	
1400	--	8,65	8,90	
1500	--	9,50	9,90	
1600	--	10,40	10,95	
1700	--	11,40	12,05	
1800	--	--	13,20	

Slika 2.8. : Prikaz zona za opterećenje snijegom s pripadnim vrijednostima

2.5. Opterećenje vjetrom

Za zgrade visine manje od 200 m može se koristiti pojednostavljeni postupak proračuna vjetrovnog opterećenja tako da se djelovanje vjetra uzima kao zamjenjujuće statičko opterećenje.

Tlak vjetra na vanjske površine w_e računa se prema izrazu:

$$w_e = q_{ref} \cdot c_e(z_e) \cdot c_{pe}$$

gdje je:

q_{ref} → tlak srednje brzine vjetra

$c_e(z_e), c_e(z_i)$ → koeficijenti izloženosti

c_{pe}, c_{pi} → koeficijenti vanjskog i unutarnjeg tlaka

Tlak srednje brzine vjetra određuje se izrazom:

$$q_{ref} = \frac{\rho}{2} v_{ref}^2$$

gdje je:

v_{ref} → poredbena brzina vjetra

ρ → gustoća zraka

Poredbena brzina vjetra određuje se prema osnovnoj vrijednosti poredbene brzine vjetra $v_{ref,0}$

Koja je prikazana u zemljovidu Hrvatske za područja opterećenja vjetrom.

$$v_{b0} = 30 \text{ m/s}$$

Osnovna brzina vjetra:

$$v_b = c_{dir} \cdot c_{season} \cdot v_{b(0)} = 1,0 \cdot 1,0 \cdot 30 = 30 [m/s]$$

Osnovni tlak vjetra:

$$q_b = \frac{1}{2} \cdot \rho \cdot v_b^2 = \frac{1}{2 \cdot 1000} \cdot 1,25 \cdot 30^2 = 0,563 [kN / m^2]$$

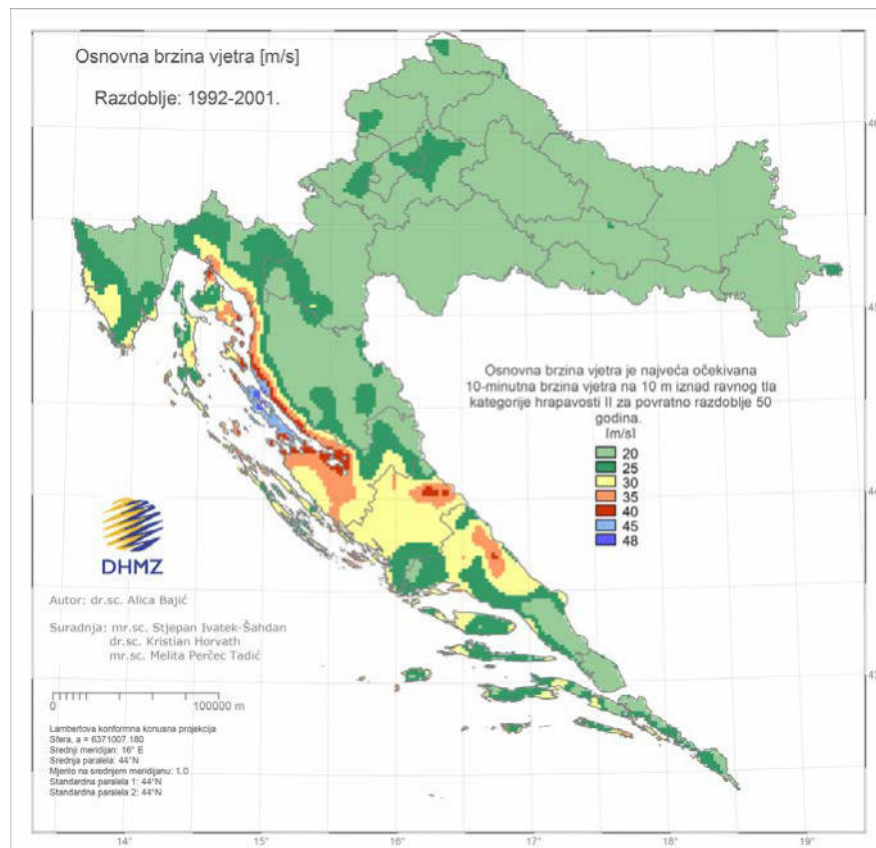

Slika 2.9. : Karta osnovne brzine vjetra Hrvatske

2.6. Potresno opterećenje

Razlika u pouzdanosti konstrukcije na potresno opterećenje, regulirano je preko razreda važnosti građevine:

Razred važnosti	Opis i namjena zgrade	Faktor važnosti zgrade γ_i
I	Zgrade manje važnosti za javnu sigurnost	0,8
II	Zgrade čija je potresna otpornost važna zbog posljedica vezanih uz rušenje	1,2
III	Obične zgrade koje ne pripadaju drugim razredima	1,0
IV	Zgrade čija je cjelovitost neposredno nakon potresa životno važna za zaštitu ljudi	1,4

Tablica 2.10. : Faktor važnosti zgrade za potresno opterećenje

Za predmetnu građevinu uzima se razred važnosti 1,0.

Građevina se projektira na horizontalno potresno djelovanje, opisane dvjema okomitim komponentama S_x i S_y .

Proračunska potresna sila na građevinu iznosi:

$$F_{bd} = S_d(T_1) \cdot \frac{W}{g} \cdot \lambda$$

gdje je:

$S_d(T_1)$ → Proračunska vrijednost ubrzanja tla u funkciji perioda osciliranja konstrukcije

$\frac{W}{g}$ → Ukupna sudjelujuća masa zgrade u trenutku djelovanja potresa

λ → Korekcijski faktor (vrijednost jednaka 1)

Za kategoriju A temeljnog tla očitano je:

$$S = 1,0$$

$$T_b = 0,15[s]$$

$$T_c = 0,40[s]$$

$$T_d = 2,00[s]$$

$$q = q_0 \cdot k_w$$

$$q_0 = q_{\min} = 2,50$$

$$q = 2,50 \cdot 1,00 = 2,50$$

$$S_d(T_1) = \frac{a_g \cdot S \cdot 2,5}{q}$$

Vlastita težina konstrukcije:

	Površina [m ²]	Visina [m]	Volumen [m ³]	γ [kg/m ³]	G [kN]
Zidani zidovi	15,49	2,40	32,75	11,00	360,21
Otvori - prozori			3,03		
Otvori - vrata			1,40		
Vertikalni serklaži	1,25	2,40	2,99	25,00	74,70
Horizontalni serklaži	18,71	0,20	3,74	25,00	93,53
Međukatna konstrukcija	119,14	0,16	19,06	25,00	476,56
G ukupno - prizemlje					1005,00
Zidani zidovi	15,49	2,40	34,24	11,00	376,60
Otvori - prozori			2,54		
Otvori - vrata			0,40		
Vertikalni serklaži	1,25	2,40	2,99	25,00	74,70
Horizontalni serklaži	18,71	0,20	3,74	25,00	93,55
Krovna konstrukcija	126,04	0,16	20,17	25,00	504,16
Nadozid	9,00	0,60	5,40	25,00	135,00
G ukupno - kat					1184,01
G ukupno					2189,00

Vrijednosti horizontalnih vršnih ubrzanja tla za predmetno područje:

$$a_g = 0,219g (T_p = 475g)$$

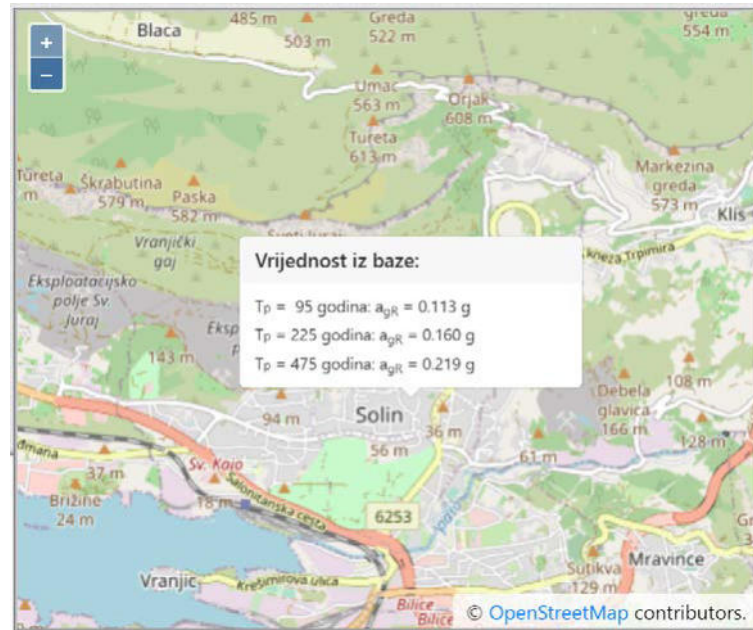

Slika 2.12. : Vrijednosti horizontalnih vršnih ubrzanja tla za lokaciju Solin

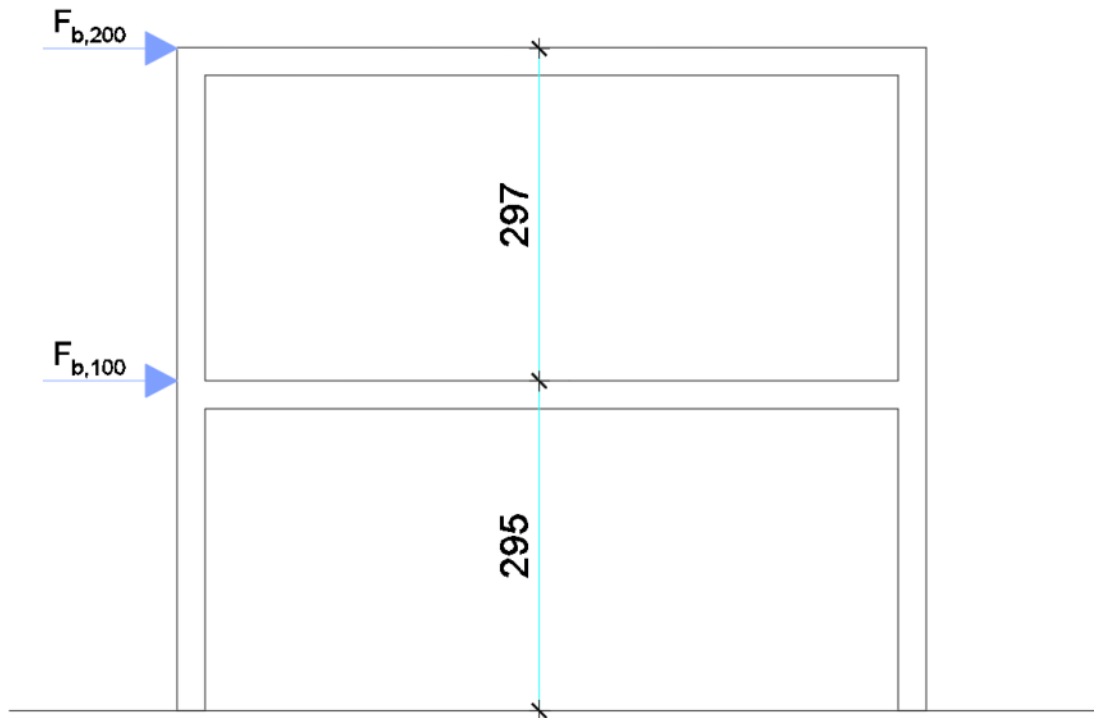

Slika 2.13. : Skica nanošenja potresnih sila

Proračun potresne sile:

$$a_g = 0,113g (T_p = 95g)$$

$$S_d(T_1) = a_g \cdot S \cdot \frac{\beta_0}{q} = 0,219 \cdot 9,81 \cdot 1 \cdot \frac{2,5}{2,5}$$

$$S_d(T_1) = 2,148$$

$$F_{bd} = S_d(T_1) \cdot \frac{W}{g} \cdot \lambda$$

$$F_{bd} = 2,148 \cdot \frac{2189,00}{9,81} \cdot 1$$

$$F_{bd} = 479,30 [kN]$$

Seizmičke sile po etažama:

$$F_{bd,i} = \gamma_1 \cdot F_{bd} \cdot \frac{h_i \cdot W_i}{\sum h_i \cdot W_i}$$

$$F_{b,100} = 1 \cdot 479,30 \cdot \frac{2,95 \cdot 1005,00}{2,95 \cdot 1005,00 + 5,92 \cdot 1184,01}$$

$$F_{b,100} = 142,47 [kN]$$

$$F_{b,200} = 1 \cdot 479,30 \cdot \frac{5,92 \cdot 1184,01}{2,95 \cdot 1005,00 + 5,92 \cdot 1184,01}$$

$$F_{b,200} = 336,83 [kN]$$

Sila od potresa je puno veća od sile vjetra te se u daljnji proračun kao horizontalno opterećenje uzima samo potres.

Sile od potresa po m² ploče:

Krovnna ploča :

$$\frac{336,83}{126} = 2,67 [kN / m^2]$$

Međukatna konstrukcija:

$$\frac{142,47}{119} = 1,20 [kN / m^2]$$

Proračun se vrši s 4 kombinacije opterećenja:

- 1.) 1,35 (G+ΔG) + 1,50 (Q) → Proračun stropnih konstrukcija
- 2.) 1,00 (G+ΔG+Q) → Proračun reakcija i progiba stropnih konstrukcija
- 3.) 1,00 (G+ΔG) + 0,30 (Q) + 1,00 (S_x) + 0,30 (S_y) → Djelovanje potresa
- 4.) 1,00 (G+ΔG) + 0,30 (Q) + 0,30 (S_x) + 1,00 (S_y) → Djelovanje potresa

3. Analiza numeričkog modela

3.1. Prikaz numeričkog modela

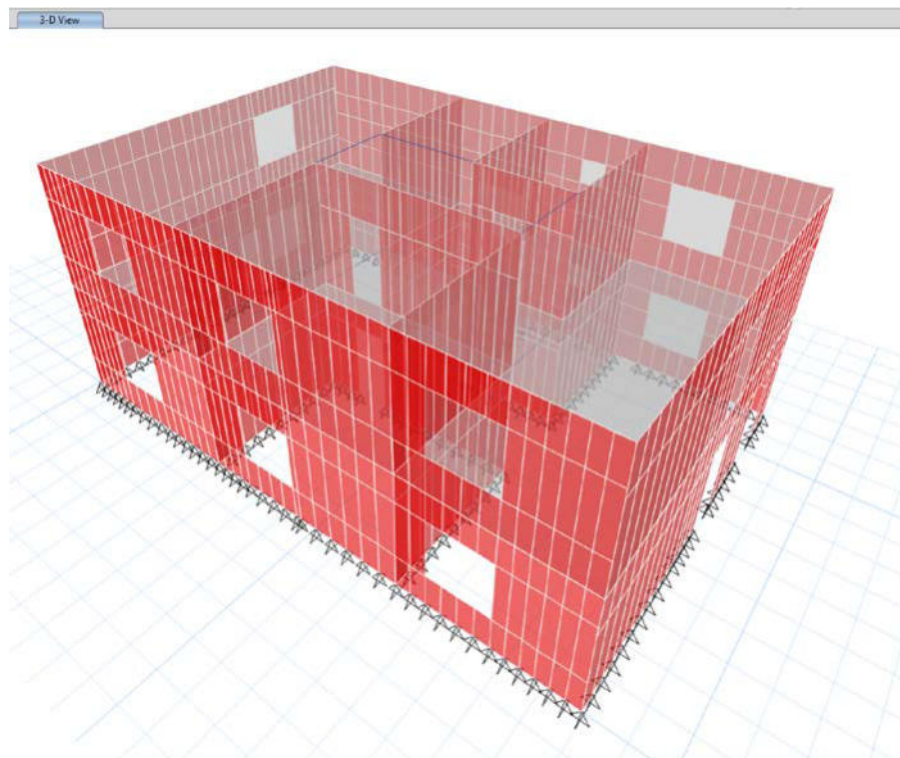
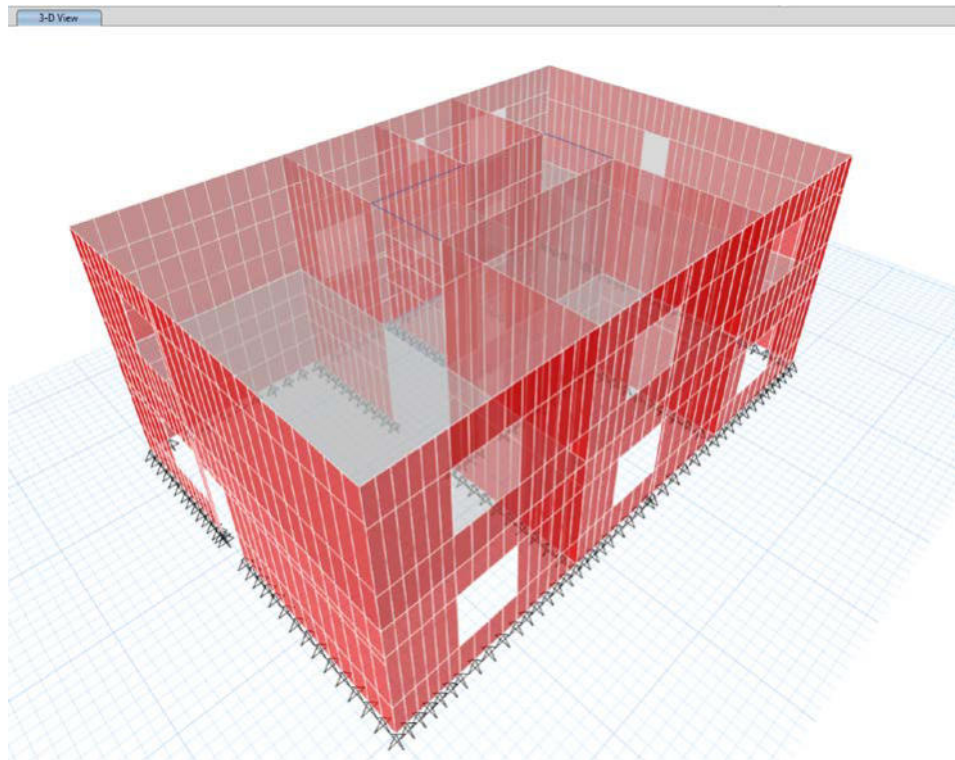

Slika 3.1. : Numerički model konstrukcije

3.2. Prikaz maksimalnog progiba ploče (2.kombinacija)

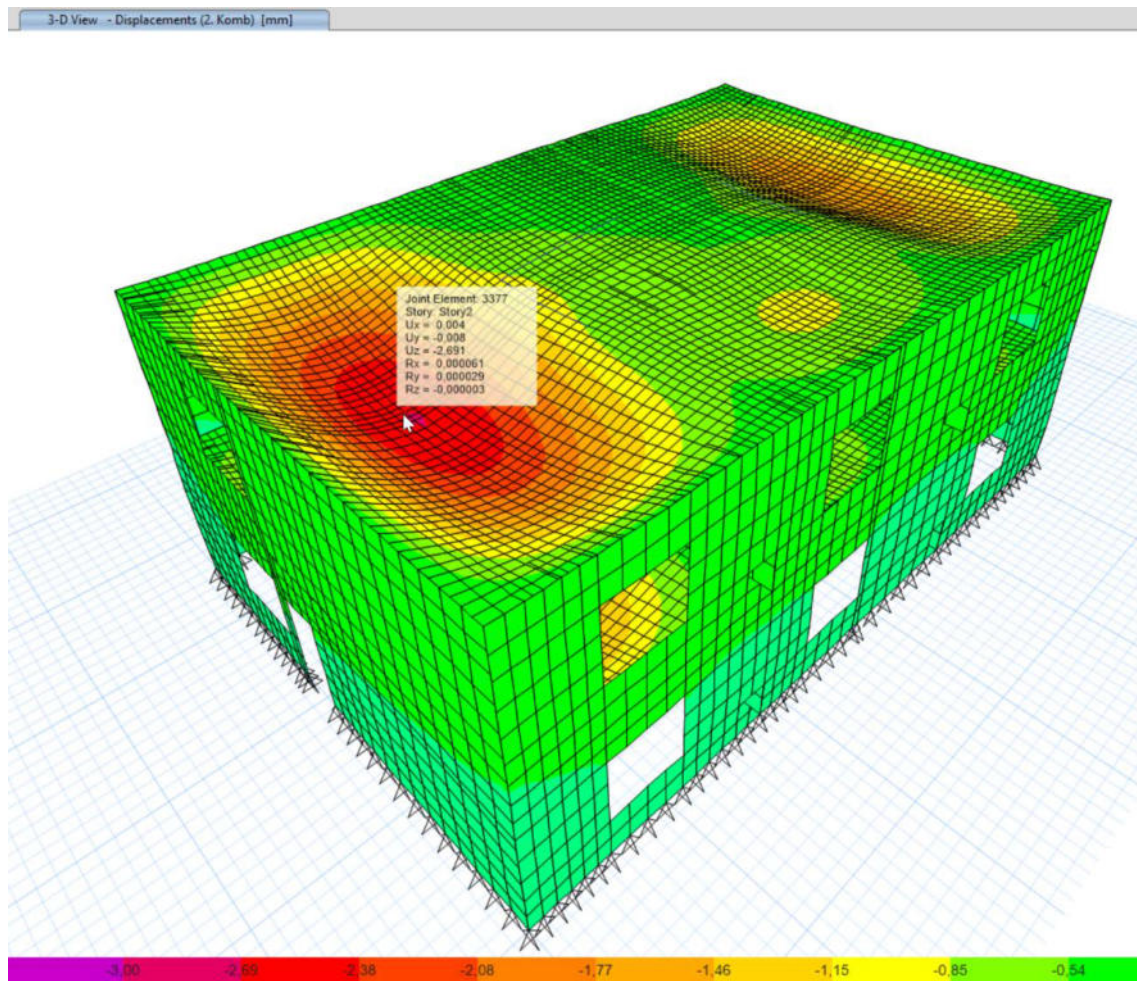

Slika 3.2. : Maksimalni progib ploče

3.3. Prikaz momenta M11

Međukatna konstrukcija:

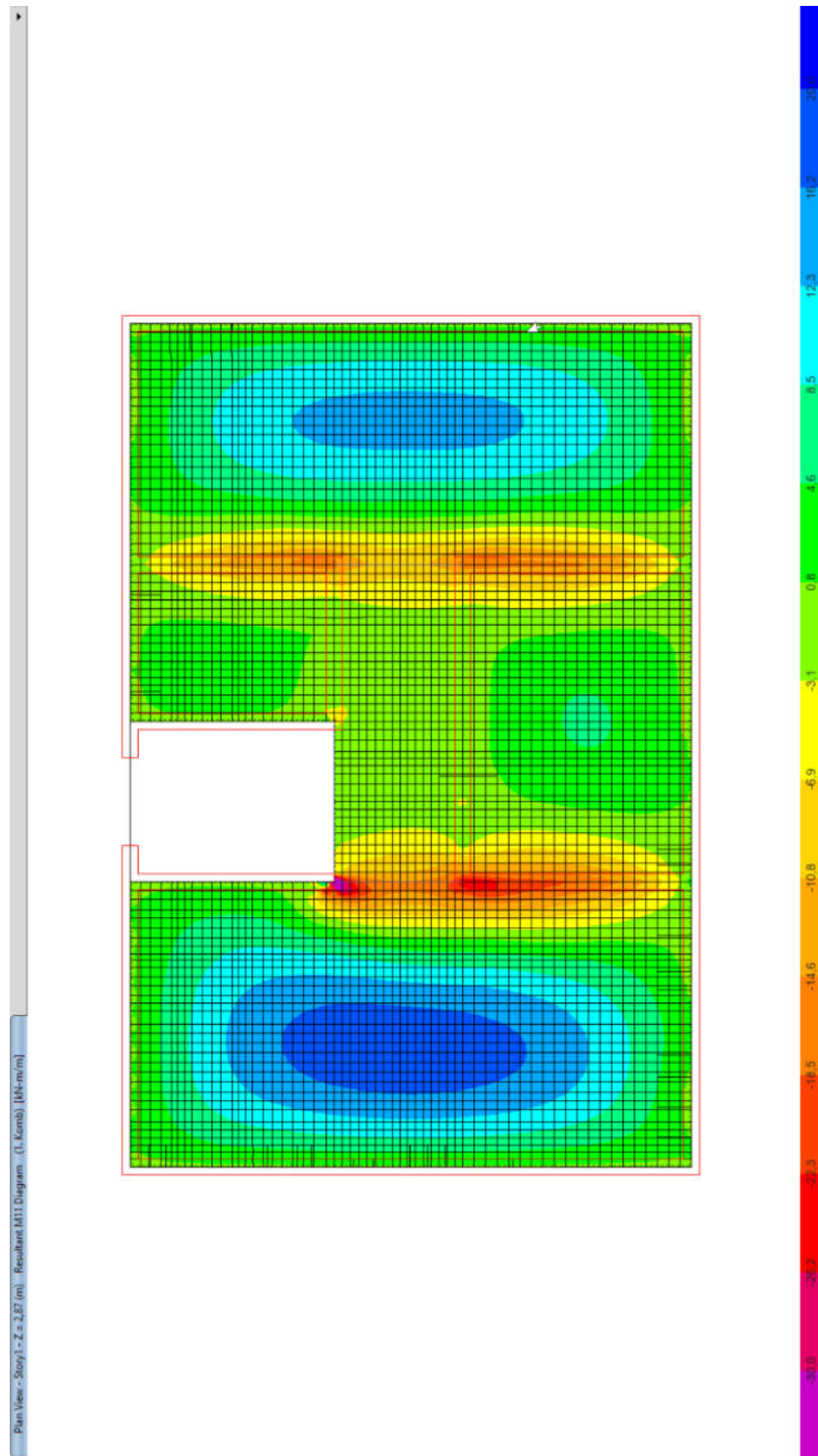

Slika 3.3. : M11 – međukatna konstrukcija

Krovna ploča:

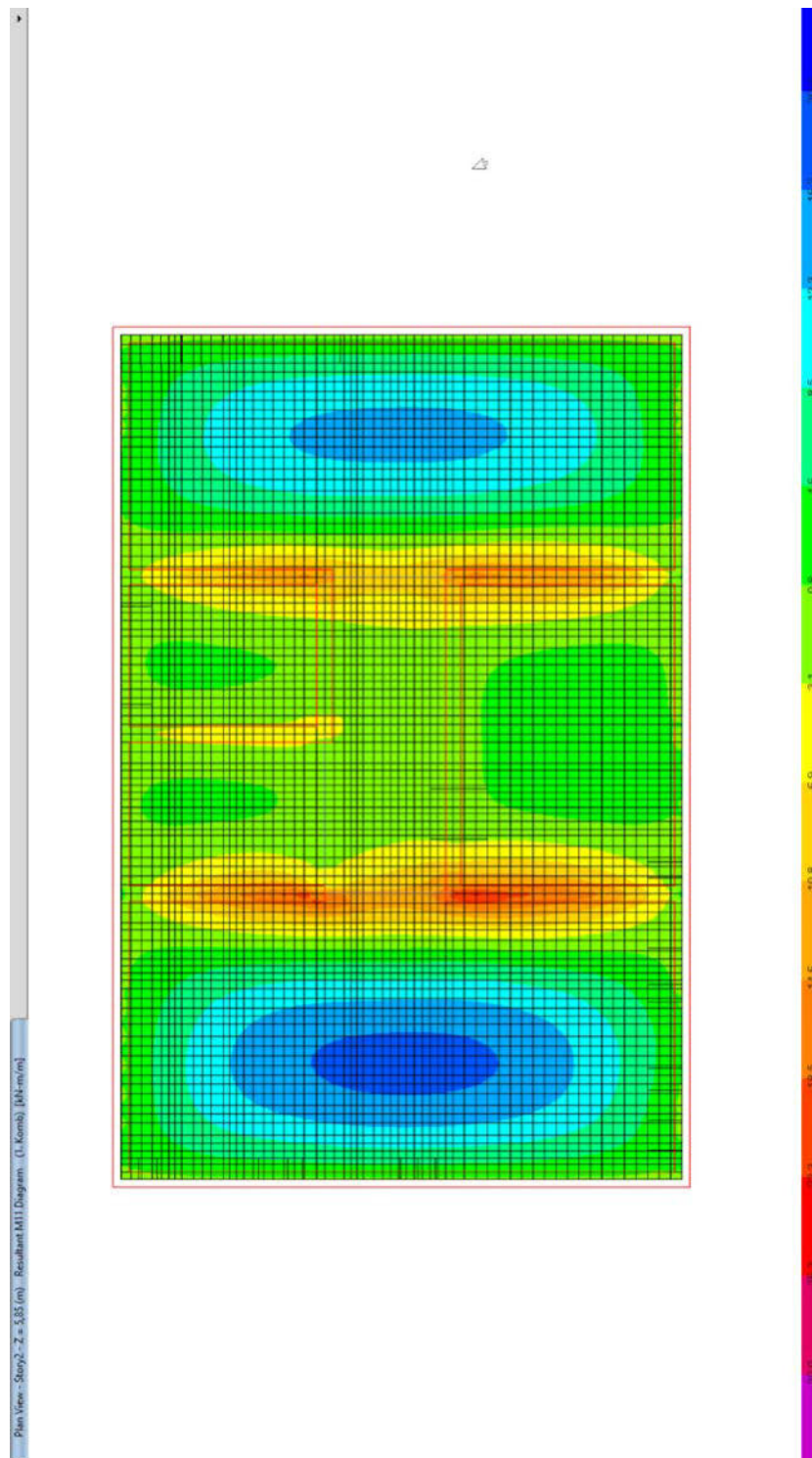

Slika 3.4. : M11 – krovna ploča

3.4. Prikaz momenta M22

Međukatna konstrukcija:

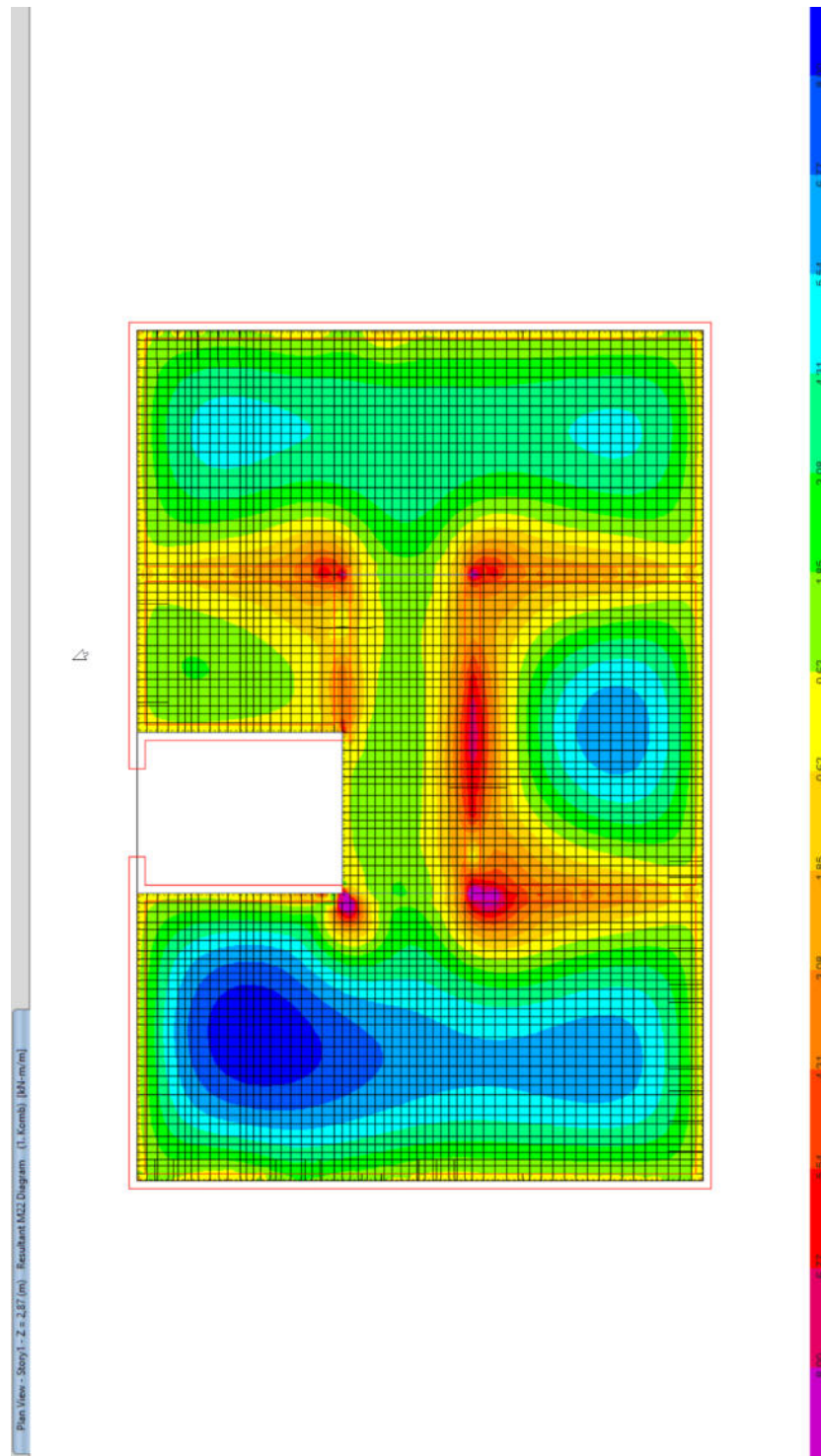

Slika 3.5. : M22 – međukatna konstrukcija

Krovna ploča:

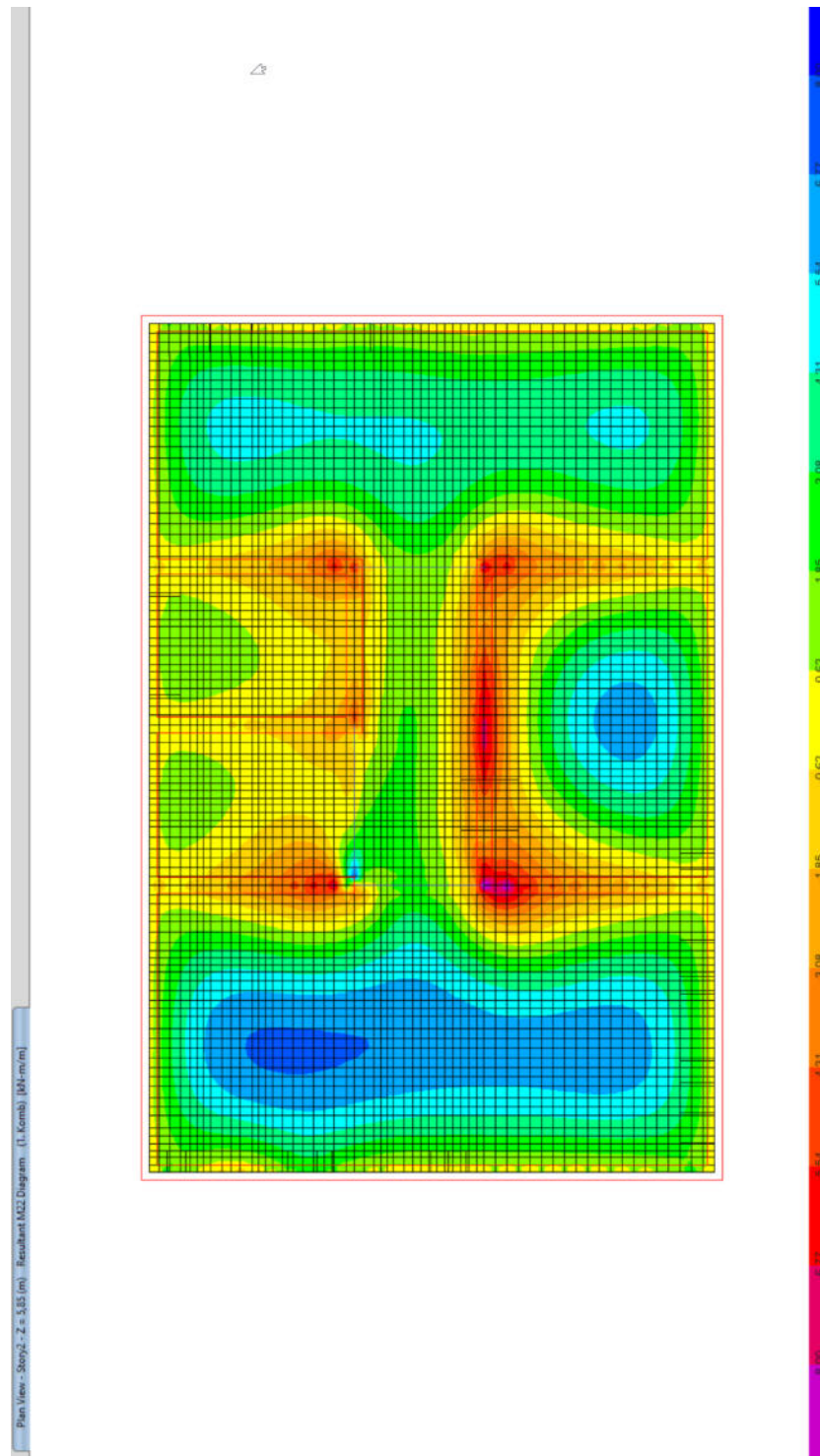

Slika 3.6. : M22 – krovna ploča

Krovna ploča:

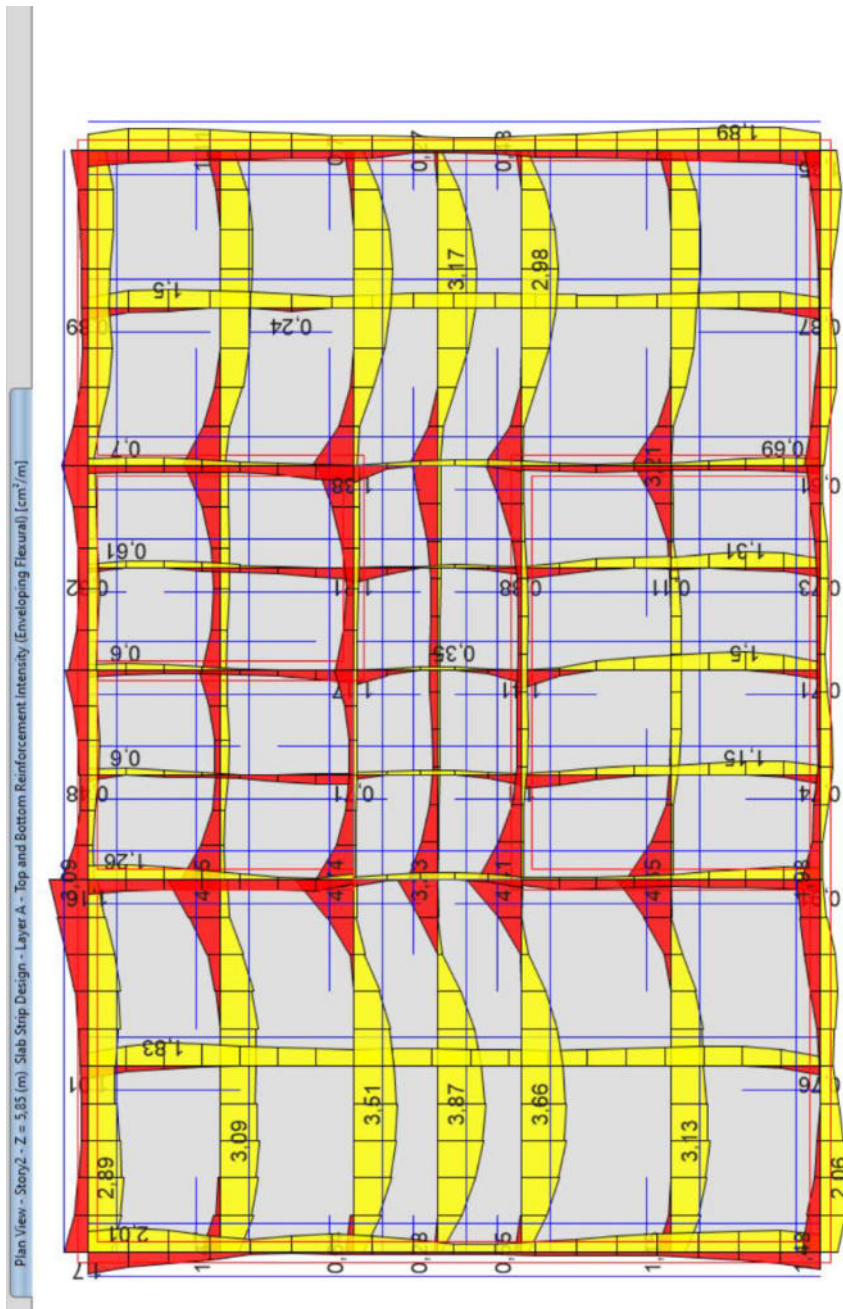

Slika 3.8. : Armatura krovne ploče

3.6 Prikaz reakcija

	Output Case	Case Type	FX kN	FY kN	FZ kN
▶	Dead	LinStatic	0	0	2134,5378
	Sx	LinStatic	-455,9159	0	0
	Sy	LinStatic	0	-455,9159	0

Vlastita težina odgovara proračunatoj.

Reakcije od potresne sile odgovaraju nanesejoj sili F_{bd}

$$\frac{S_d}{g} = \frac{\text{reakcija } y}{\text{reakcija } z}$$

$$\frac{2,148}{9,81} = \frac{455,92}{2135} = 0,213$$

4. Proračun zidova

4.1. Općenito

Otpornost zida pri djelovanju posmične sile

U graničnom stanju nosivosti, proračunska vrijednost posmične sile koja djeluje na zid (V_{ED}) mora biti manja od proračunske otpornosti zida na posmičnu silu V_{RD} , tako da je zadovoljen uvjet:

$$V_{ED} \leq V_{RD}$$

Karakteristična posmična čvrstoća zida:

Karakteristična početna posmična čvrstoća zida f_{vko} određuje se iz tabličnih vrijednosti danih u normi HRN EN 1996-1-1 i iznosi:

Zidni element	f_{vko} (N/mm ²)			
	Mort opće namjene		Tankoslojni mort (debljine horizontalnih sljubnica $\geq 0,5$ mm i $\leq 3,0$ mm)	Lagani mort
Glina	M10 – M20	0,30	0,30	0,15
	M2,5 – M9	0,20		
	M1 – M2	0,10		
Kalcijsko-silikatni	M10 – M20	0,20	0,40	0,15
	M2,5 – M9	0,15		
	M1 – M2	0,10		
Betonski	M10 – M20	0,20	0,30	0,15
Porasti (autoklavirani aerirani)	M2,5 – M9	0,15		
Kameni	M1 – M2	0,10		

Tablica 4.1. : Karakteristična posmična čvrstoća zida f_{vko}

Projektirano ziđe zidano je s mortom marke M10 te karakteristična početna posmična čvrstoća zida iznosi:

$f_{vko} = 0,30$ N/mm² za mort M10

Karakteristična posmična čvrstoća zida f_{vk} određuje se zatim iz izraza:

$$f_{vk} = f_{vk0} + 0,4 \sigma_d$$

gdje je:

f_{vk0} → karakteristična početna posmična čvrstoća pri nultom tlačnom naprezanju

σ_d → proračunsko tlačno napreznje okomito na smjer posmika u elementu na promatranoj razini

Posmična čvrstoća služi za provjeru nosivosti zida opterećenog horizontalnom silom u vlastitoj ravnini uz pretpostavku da do sloma dolazi klizanjem po jednoj od horizontalnih sljubnica.

Vlačna čvrstoća zida:

Proračunska vrijednost posmične otpornosti zida može se odrediti izrazom:

$$\tau_{Rd} = \frac{f_{tk}}{1,5 \cdot \gamma_M} \cdot \sqrt{1 + \frac{\sigma_d \cdot \gamma_M}{f_{tk}}}$$

gdje je:

τ_{Rd} → proračunska vrijednost posmične otpornosti zida

f_{tk} → karakteristična vrijednost vlačne čvrstoće

σ_d → normalno naprezanje zida za odgovarajuću proračunsku situaciju

γ_M → parcijalni koeficijent za materijal

Zidni element	f	f _m	f _k	G	E	f _t
Puna opeka	10	0.5	2.0	40	250	0.04
Puna opeka	15	2.5	2.5	200	400	0.18
Laki keramički blok	7.5	2.0	5.0	500	4500	0.30
Opečni blok	15	2.5	2.5	300	5000	0.12
Opečni blok	15	5	3.0	300	5000	0.18
Keramizirni blok	7.5	5	3.5	500	5000	0.27
Betonski blok	7.5	5	4.0	600	6000	0.27

Tablica 4.2. : Vlačna čvrstoća zida f_t

Prikaz oznaka zidova:

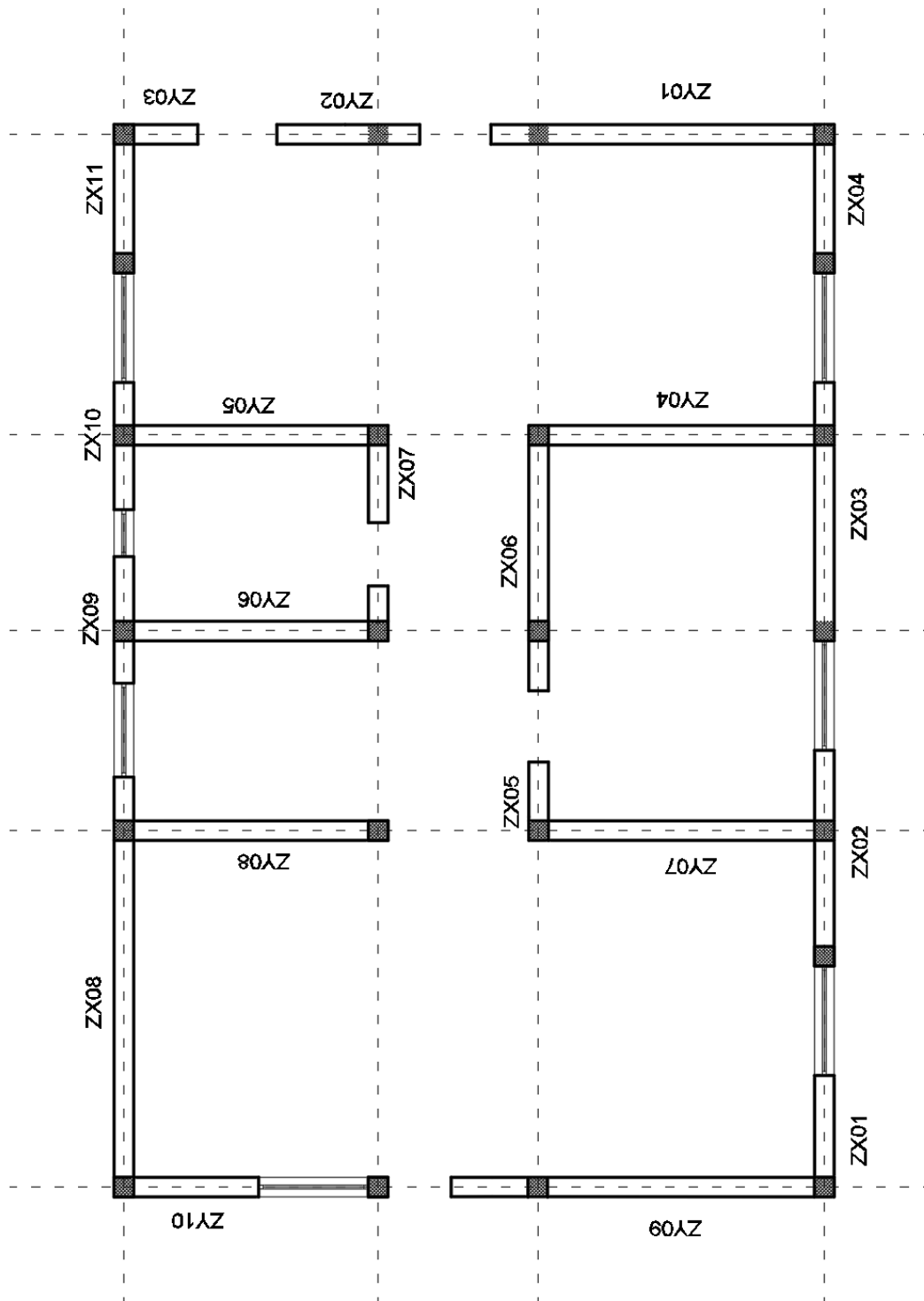

Sile u zidovima za 3. kombinaciju djelovanja:

3.) $1,00 (G+\Delta G) + 0,30 (Q) + 1,00 (S_x) + 0,30 (S_y)$,

Zid	Kombinacija	N	V	M
		kN	kN	kN-m
ZX01	3. Komb	43,46	18,9	24,04
ZX02	3. Komb	93,04	44,17	130,25
ZX03	3. Komb	102,76	63,15	190,19
ZX04	3. Komb	46,82	27,01	39,93
ZX05	3. Komb	41,87	10,74	8,62
ZX06	3. Komb	131,52	83,81	171,72
ZX07	3. Komb	16,98	5,22	3,23
ZX08	3. Komb	44,56	13,32	13,79
ZX09	3. Komb	155,54	144,89	328,93
ZX10	3. Komb	39,62	13,16	29,3
ZX11	3. Komb	51,81	16,34	35,64
ZX12	3. Komb	48,34	22,22	37,76
	Σ	816,32	462,93	
ZY01	3. Komb	126,46	19,52	52,39
ZY02	3. Komb	55,58	2,4	5,21
ZY03	3. Komb	36,12	1,31	1,41
ZY04	3. Komb	132,99	20,5	31,05
ZY05	3. Komb	114,99	15,56	21,15
ZY06	3. Komb	88,99	14,79	23,3
ZY07	3. Komb	146,17	20,72	28,72
ZY08	3. Komb	131	15,92	28
ZY09	3. Komb	152,98	23,8	71,17
ZY10	3. Komb	50,66	11,57	7,09
	Σ	1035,94	146,09	

Sile u zidovima za 4. kombinaciju djelovanja:

4.) $1,00 (G+\Delta G) + 0,30 (Q) + 0,30 (S_x) + 1,00 (S_y)$,

Zid	Kombinacija	N	V	M
		kN	kN	kN-m
ZX01	4. Komb	40,26	5,67	7,21
ZX02	4. Komb	93,04	13,25	39,08
ZX03	4. Komb	102,76	18,95	57,06
ZX04	4. Komb	46,82	8,1	11,98
ZX05	4. Komb	41,87	4,17	2,58
ZX06	4. Komb	131,52	25,14	51,52
ZX07	4. Komb	16,98	1,57	0,97
ZX08	4. Komb	44,56	4,26	4,14
ZX09	4. Komb	155,54	43,47	98,68
ZX10	4. Komb	52,83	3,95	8,79
ZX11	4. Komb	54,18	4,9	10,69
ZX12	4. Komb	48,34	6,67	11,33
	Σ	828,7	140,1	
ZY08	4. Komb	126,46	65,07	174,63
ZY09	4. Komb	55,58	8,01	17,37
ZY10	4. Komb	26	4,35	4,71
ZY06	4. Komb	132,99	68,33	81,44
ZY07	4. Komb	114,99	51,86	70,5
ZY05	4. Komb	88,99	49,29	77,66
ZY03	4. Komb	146,17	69,07	95,75
ZY04	4. Komb	131	47,56	93,34
ZY01	4. Komb	152,98	79,33	237,24
ZY02	4. Komb	50,66	14,8	23,63
	Σ	1025,82	457,67	

4.2. Prikaz sila i proračun zidova (X smjer):

ZX01

ZX02

ZX03

ZX04

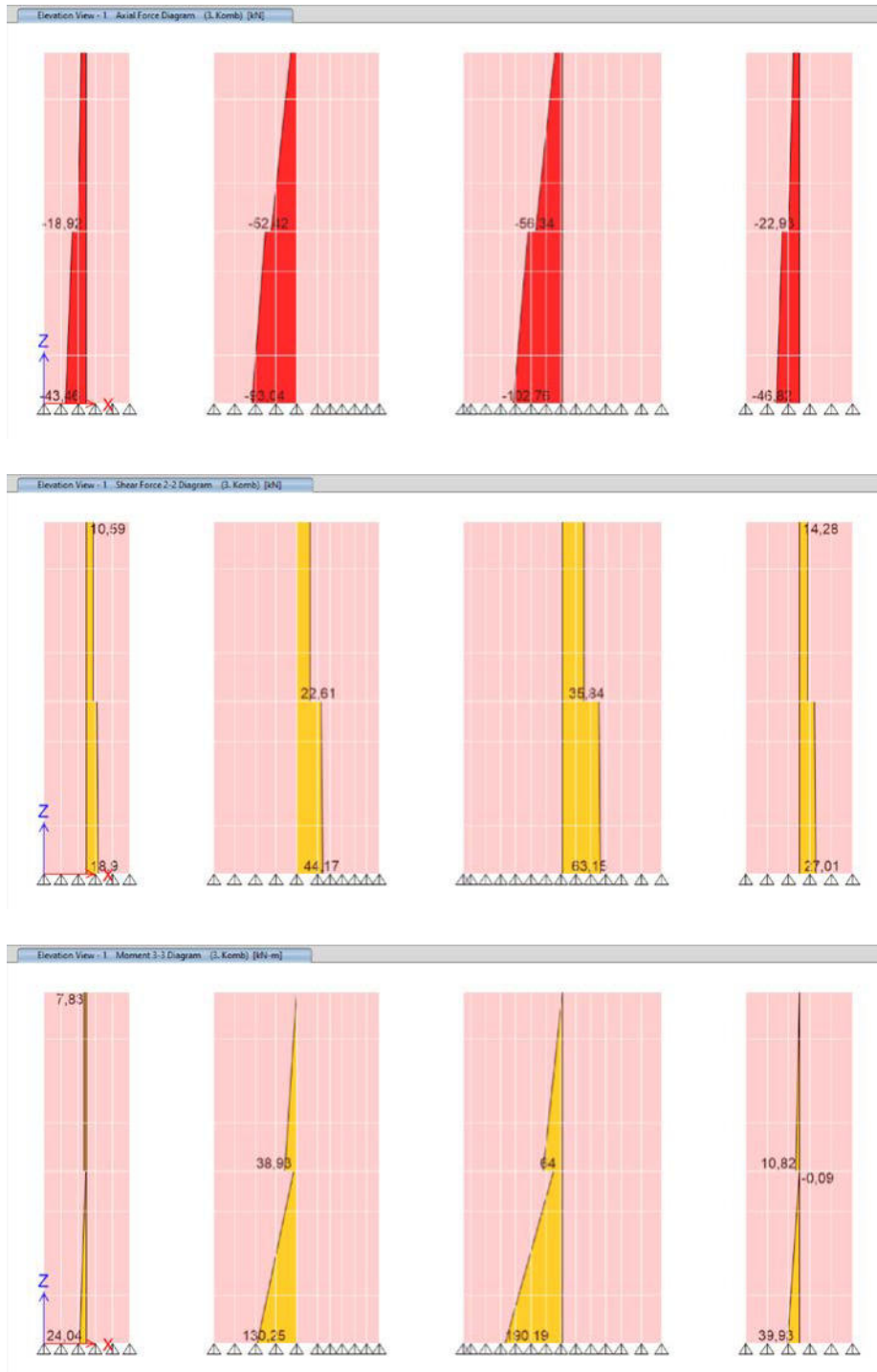

ZX05

ZX06

Elevation View - 2 - Axial Force Diagram - (3. Komb) [kN]

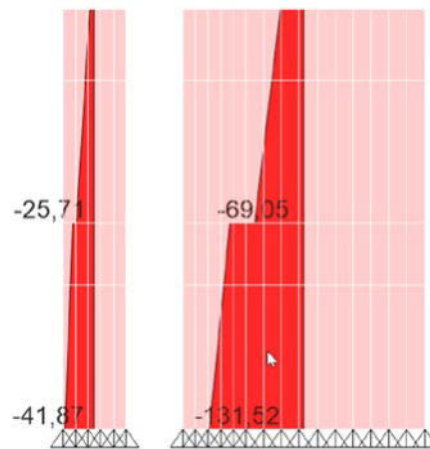

Elevation View - 2 - Shear Force 2-2 Diagram - (3. Komb) [kN]

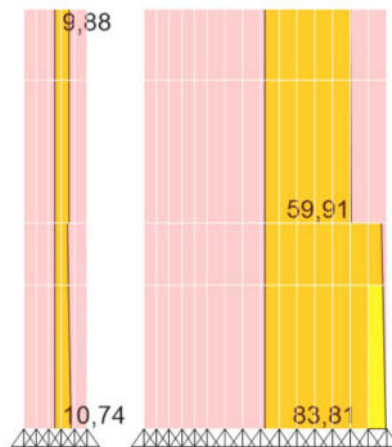

Elevation View - 2 - Moment 3-3 Diagram - (3. Komb) [kN-m]

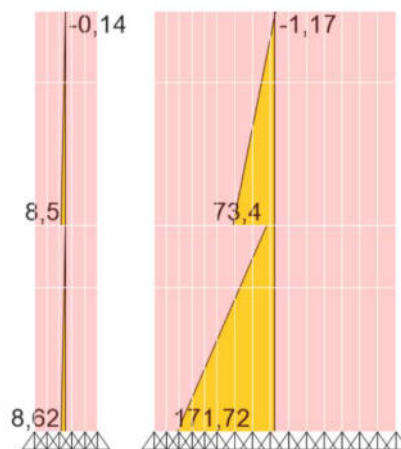

ZX07 ZX08

Elevation View - 3 Axial Force Diagram (3. Komb) [kN]

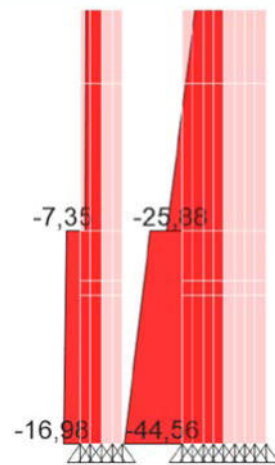

Elevation View - 3 Shear Force 2-2 Diagram (3. Komb) [kN]



Elevation View - 3 Moment 3-3 Diagram (3. Komb) [kN-m]

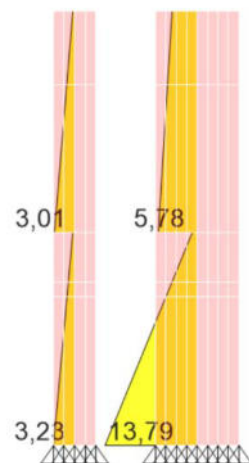

ZX09

ZX10

ZX11

ZX12

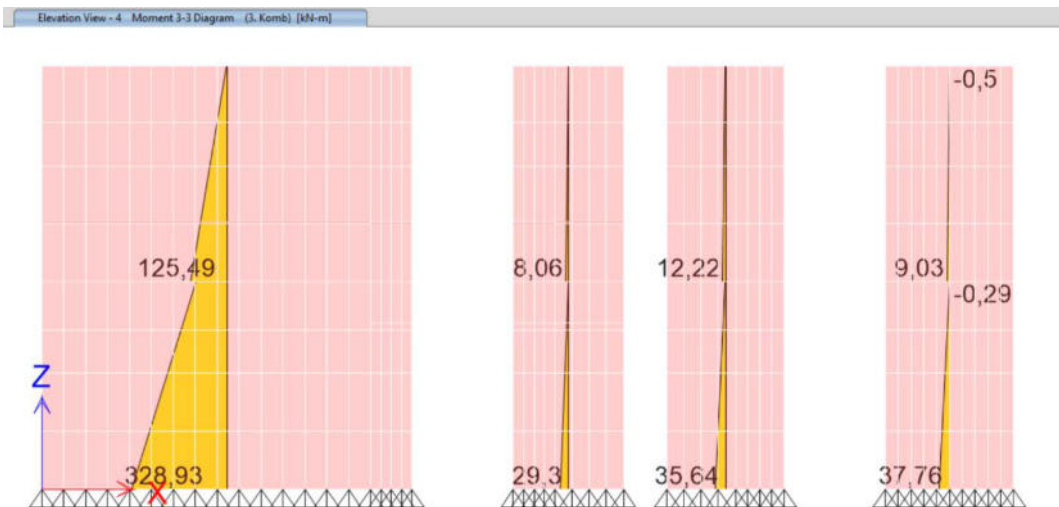
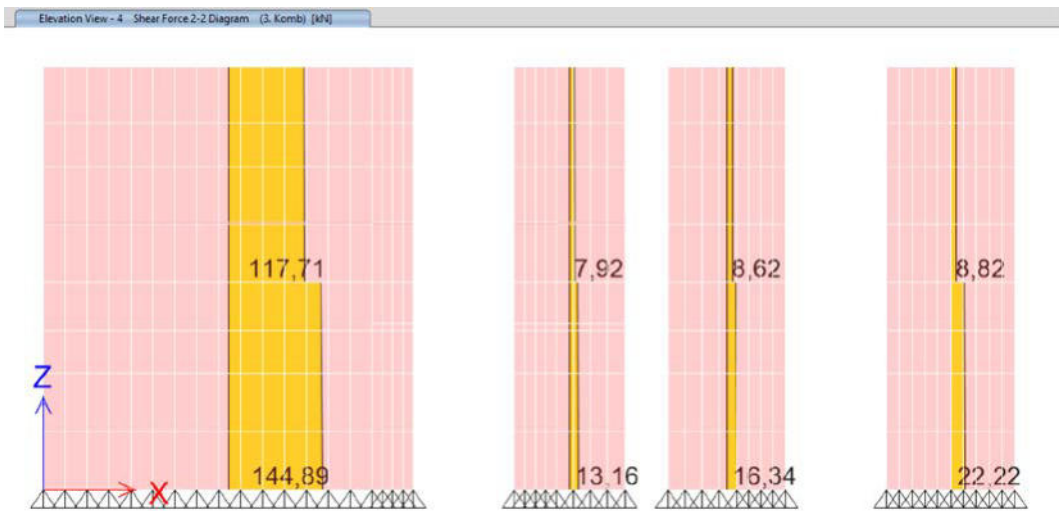
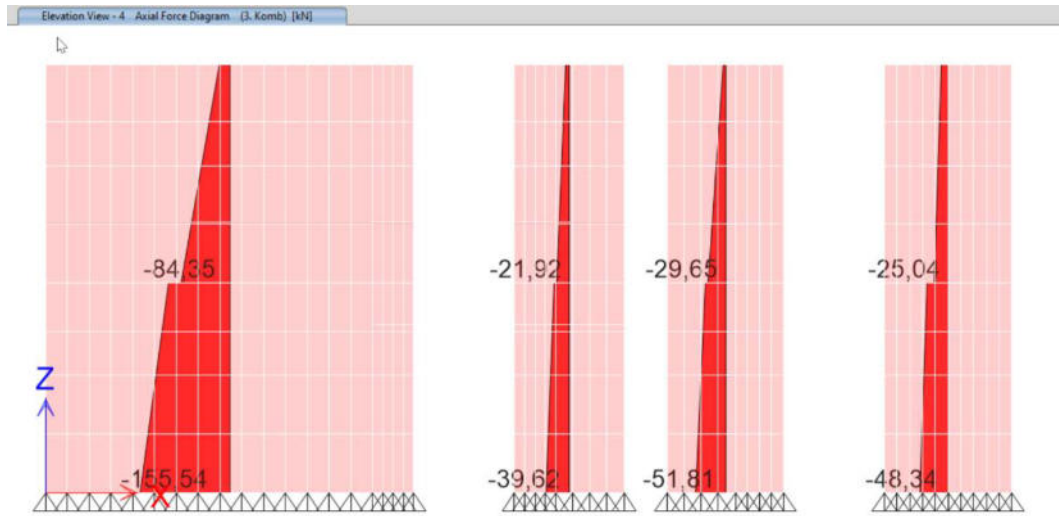

Primjer proračuna ziđa na posmik i na vlačni slom:

Zid ZX01

$$V_{ed} = 18,90[kN]$$

$$N_{ed} = 43,46[kN]$$

$$M_{ed} = 24,04[kNm]$$

$$L = 1,43[m]$$

Nosivost na posmik:

$$L_c = \left(\frac{L}{2}\right) \cdot \left(1 + \frac{L \cdot N_{ed}}{6 \cdot M_{ed}}\right) = \left(\frac{1,43}{2}\right) \cdot \left(1 + \frac{1,43 \cdot 43,46}{6 \cdot 24,04}\right) = 1,02[m]$$

$$A_{wc} = t \cdot L_c = 25 \cdot 102 = 2550[cm^2]$$

$$\sigma_d = \frac{N_{ed}}{A_w} = \frac{43,46}{2550} = 0,017[kN/cm^2] = 0,170[N/mm^2]$$

$$f_{vk0} = 0,3[N/mm^2]$$

$$f_{vk} = f_{vk0} + 0,4 \cdot \sigma_d = 0,3 + 0,4 \cdot 0,170 = 0,368[N/mm^2]$$

$$f_{vd} = \frac{f_{vk}}{\gamma_m} = \frac{0,368}{1,5} = 0,245[N/mm^2]$$

$$V_{rd} = f_{vd} \cdot A_w = 0,245 \cdot 255000 = 62475 = 62,48[kN]$$

$$V_{rd} > V_{ed}$$

$$62,48[kN] > 18,90[kN]$$

Ziđe ima potrebnu nosivost na posmik

Vlačni slom:

$$A_w = t \cdot L = 25 \cdot 143 = 3575[cm^2]$$

$$\sigma_0 = \frac{N_{ed}}{A_w} = \frac{43,46}{3575} = 0,122[N/mm^2]$$

$$f_{tk} = 0,18[N/mm^2]$$

$$\tau_R = \frac{f_{tk}}{1,5} \cdot \sqrt{1 + \frac{\sigma_0}{f_{tk}}} = \frac{0,18}{1,5 \cdot 1,5} \cdot \sqrt{1 + \frac{0,122}{0,18}} = 0,155[N/mm^2]$$

$$H_{rh} = C_R \cdot A_w \cdot \tau_R = 0,9 \cdot 357500 \cdot 0,155 = 49,98[kN]$$

$$V_{Rd} = \frac{H_{rh}}{\gamma_M} = \frac{49,98}{1,5} = 33,32[kN]$$

$$V_{RHd} > V_{ed}$$

$$33,32[kN] > 18,90[kN]$$

Ziđe zadovoljava na vlačni slom

Provjera zidova u X smjeru na posmik:

Zid	N	V	M	L	L _c	A _c	σ _d	f _{vk}	f _{vd}	V _{rd}	V _{ed}	Uvjet
	kN	kN	kNm	[m]	[m]	[cm ²]	[N/mm ²]	[N/mm ²]	[N/mm ²]	[kN]	[kN]	
ZX01	43,46	18,9	24,04	1,43	1,02	2557,67	0,170	0,37	0,245	62,74	18,9	Zadovoljava
ZX02	93,04	44,17	130,25	2,75	1,83	4562,92	0,204	0,38	0,254	116,07	44,17	Zadovoljava
ZX03	102,76	63,15	190,19	3,3	2,14	5350,81	0,192	0,38	0,251	134,42	63,15	Zadovoljava
ZX04	46,82	27,01	39,93	1,9	1,30	3256,86	0,144	0,36	0,238	77,62	27,01	Zadovoljava
ZX05	41,87	10,74	8,62	0,87	0,74	1853,44	0,226	0,39	0,260	48,23	10,74	Zadovoljava
ZX06	131,52	83,81	171,72	3,4	2,44	6094,54	0,216	0,39	0,258	156,96	83,81	Zadovoljava
ZX07	16,98	5,22	3,23	0,6	0,46	1144,27	0,148	0,36	0,240	27,41	5,22	Zadovoljava
ZX08	44,56	13,32	13,79	1,15	0,93	2327,80	0,191	0,38	0,251	58,44	13,32	Zadovoljava
ZX09	155,54	144,89	328,93	5,25	3,71	9277,79	0,168	0,37	0,245	227,03	144,89	Zadovoljava
ZX10	39,62	13,16	29,3	1,6	1,09	2721,18	0,146	0,36	0,239	64,99	13,16	Zadovoljava
ZX11	51,81	16,34	35,64	1,6	1,11	2775,31	0,187	0,37	0,250	69,32	16,34	Zadovoljava
ZX12	48,34	22,22	37,76	1,8	1,25	3114,13	0,155	0,36	0,241	75,17	22,22	Zadovoljava

Provjera zidova u X smjeru na vlačni slom:

Zid	N	V	M	L	Aw	σ_0	τ_{rd}	Hrh	Vrd	Ved	Uvjet
	kN	kN	kN-m	[m]	[cm ²]	[N/mm ²]	[N/mm ²]	[kN]	[kN]	[kN]	
ZX01	43,46	18,9	24,04	1,43	3575	0,122	0,155	49,98	33,32	18,9	Zadovoljava
ZX02	93,04	44,17	130,25	2,75	6875	0,135	0,159	98,28	65,52	44,17	Zadovoljava
ZX03	102,76	63,15	190,19	3,3	8250	0,125	0,156	115,90	77,27	63,15	Zadovoljava
ZX04	46,82	27,01	39,93	1,9	4750	0,099	0,149	63,82	42,55	27,01	Zadovoljava
ZX05	41,87	10,74	8,62	0,87	2175	0,193	0,173	33,79	22,53	10,74	Zadovoljava
ZX06	131,52	83,81	171,72	3,4	8500	0,155	0,164	125,19	83,96	83,81	Zadovoljava
ZX07	16,98	5,22	3,23	0,6	1500	0,113	0,153	20,68	13,78	5,22	Zadovoljava
ZX08	44,56	13,32	13,79	1,15	2875	0,155	0,164	42,36	28,24	13,32	Zadovoljava
ZX09	155,54	144,89	328,93	5,25	13125	0,119	0,155	182,54	121,69	144,89	Ne zadovoljava
ZX10	39,62	13,16	29,3	1,6	4000	0,099	0,149	53,79	35,86	13,16	Zadovoljava
ZX11	51,81	16,34	35,64	1,6	4000	0,130	0,157	56,65	37,77	16,34	Zadovoljava
ZX12	48,34	22,22	37,76	1,8	4500	0,107	0,152	61,41	40,94	22,22	Zadovoljava

4.3. Prikaz sila i proračun zidova (Y smjer):

ZY01

ZY02

ZY03

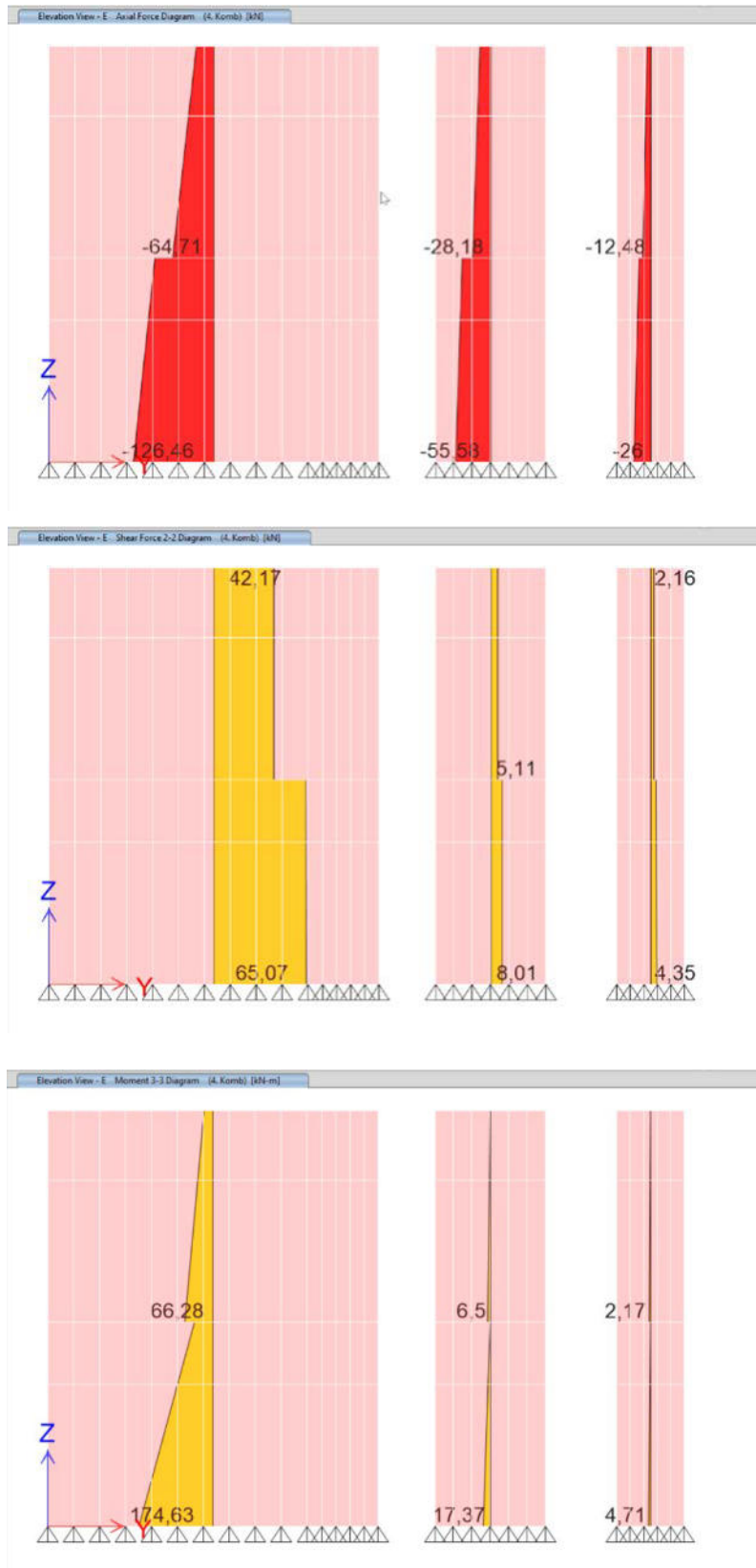

ZY04

ZY05

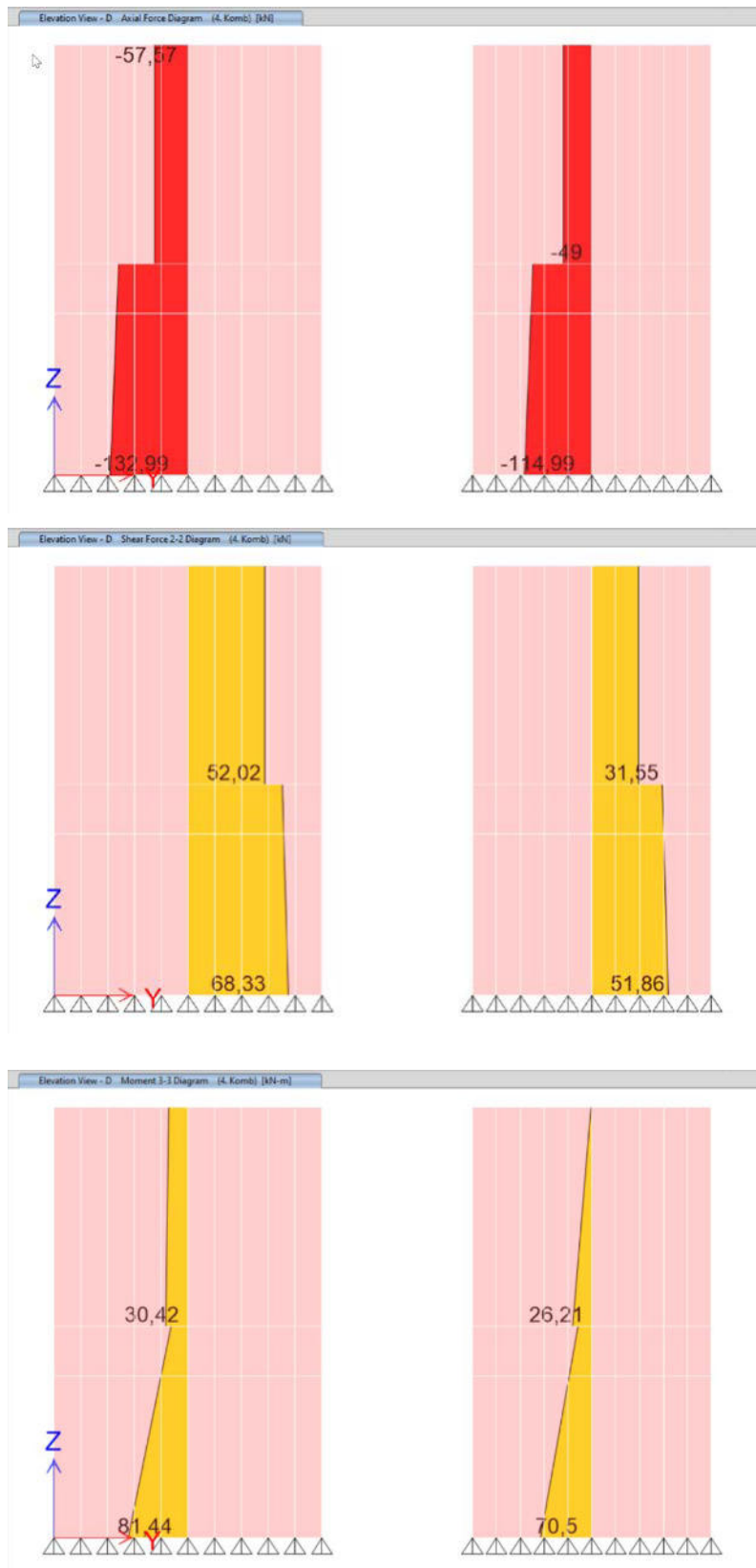

ZY06

Elevation View - C Axial Force Diagram (4. Komb.) (kN)

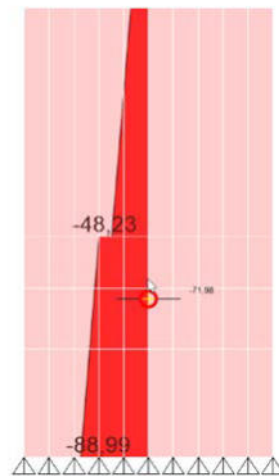

Elevation View - C Shear Force 2-2 Diagram (4. Komb.) (kN)

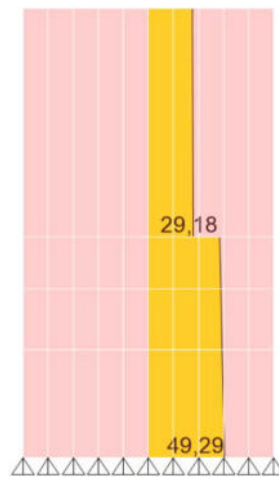

Elevation View - C Moment 3-3 Diagram (4. Komb.) (kN-m)

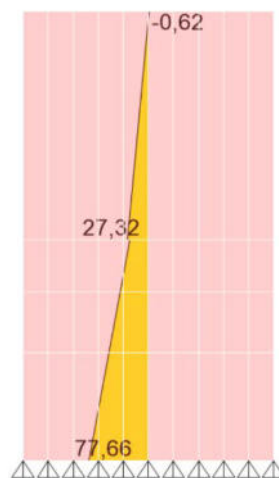

ZY07

ZY08

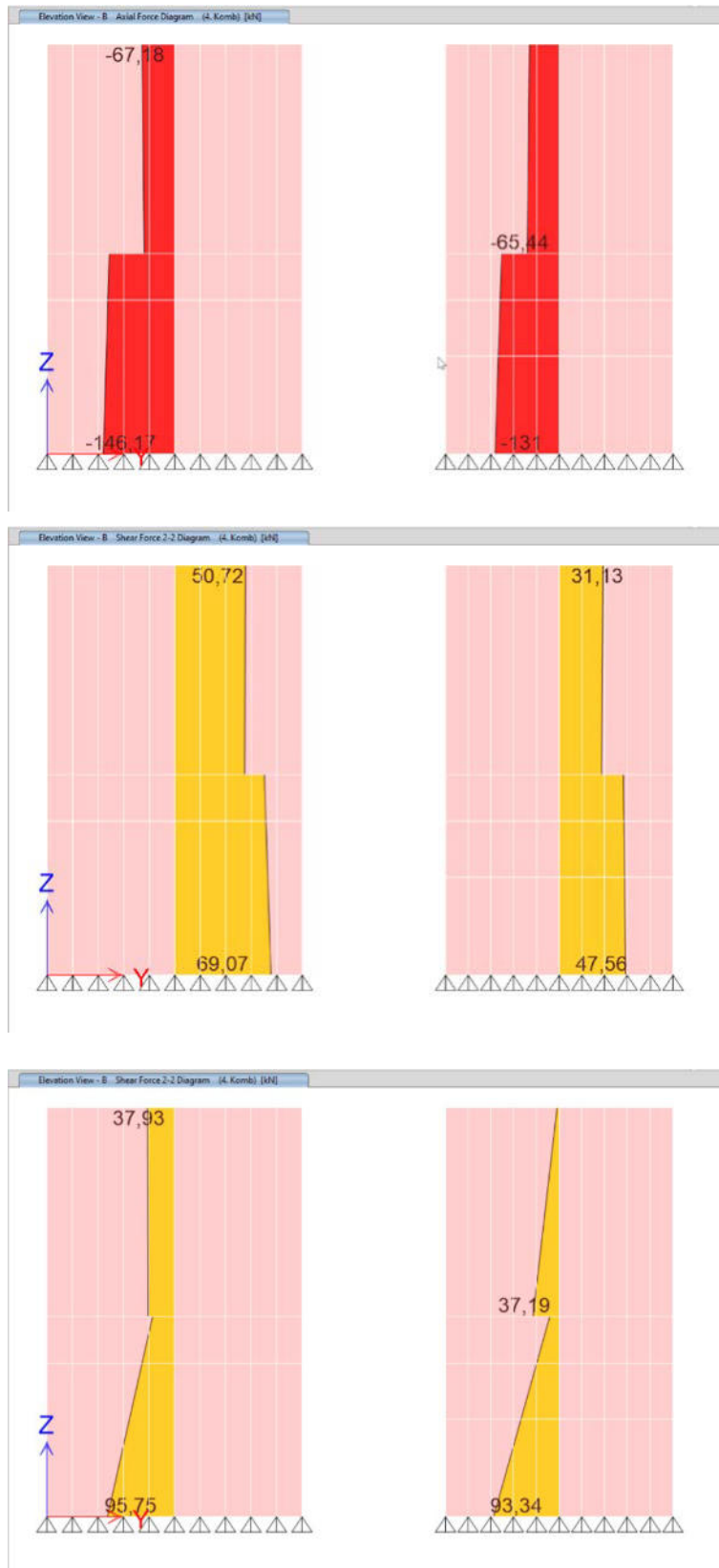

ZY09

ZY10

Elevation View - A. Axial Force Diagram (A Komb) [kN]

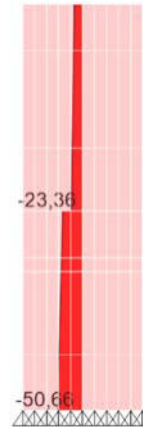
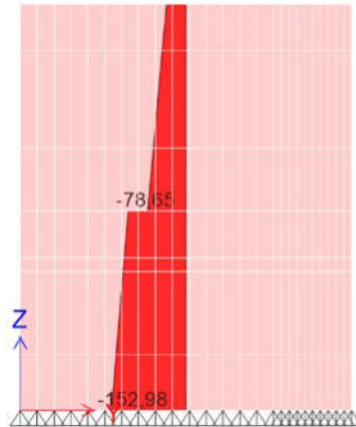

Elevation View - A. Shear Force 2-2 Diagram (A Komb) [kN]

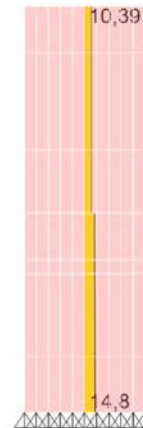
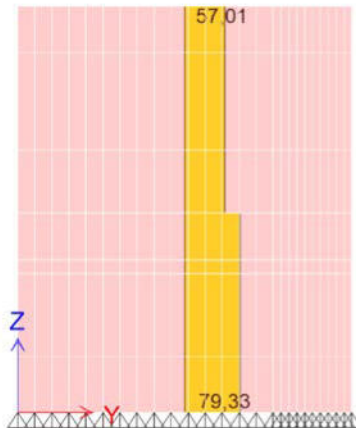

Elevation View - A. Shear Force 2-2 Diagram (A Komb) [kN]

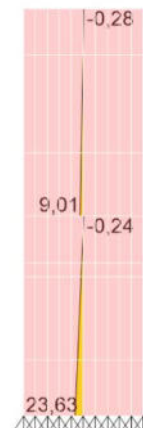
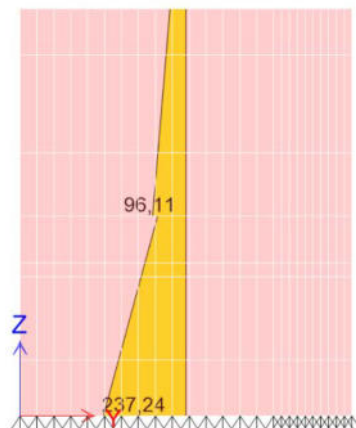

Provjera zidova u Y smjeru na posmik:

Zid	N [kN]	V [kN]	M [kNm]	L [m]	L _c [m]	A _c [cm ²]	o _d [N/mm ²]	f _{vk} [N/mm ²]	f _{vd} [N/mm ²]	V _{rd} [kN]	V _{ed} [kN]	Uvjet
ZY01	126,46	65,07	174,63	4,25	3,22	8037,53	0,157	0,36	0,242	194,47	65,07	Zadovoljava
ZY02	55,58	8,01	17,37	1,85	1,84	4594,00	0,121	0,35	0,232	106,70	8,01	Zadovoljava
ZY03	26	4,35	4,71	0,95	0,89	2225,41	0,117	0,35	0,231	51,44	4,35	Zadovoljava
ZY04	132,99	68,33	81,44	3,65	3,64	9094,87	0,146	0,36	0,239	217,36	68,33	Zadovoljava
ZY05	114,99	51,86	70,5	3,25	3,06	7651,69	0,150	0,36	0,240	183,70	51,86	Zadovoljava
ZY06	88,99	49,29	77,66	3,25	2,63	6584,06	0,135	0,35	0,236	155,41	49,29	Zadovoljava
ZY07	146,17	69,07	95,75	3,65	3,52	8799,55	0,166	0,37	0,244	214,97	69,07	Zadovoljava
ZY08	131	47,56	93,34	3,25	2,86	7150,87	0,183	0,37	0,249	177,95	47,56	Zadovoljava
ZY09	152,98	79,33	237,24	4,75	3,59	8968,55	0,171	0,37	0,245	220,17	79,33	Zadovoljava
ZY10	50,66	14,8	23,63	1,70	1,37	3415,80	0,148	0,36	0,240	81,83	14,8	Zadovoljava

Provjera zidova u Y smjeru na vlačni slom:

Zid	N	V	M	L	Aw	σ_0	τ_{rd}	Hrh	Vrd	Ved	Uvjet
	kN	kN	kN-m	[m]	[cm ²]	[N/mm ²]	[N/mm ²]	[kN]	[kN]	[kN]	
ZY01	126,46	65,07	174,63	4,25	10625	0,119	0,155	147,90	98,60	65,07	Zadovoljava
ZY02	55,58	8,01	17,37	1,85	4625	0,120	0,155	64,50	43,00	8,01	Zadovoljava
ZY03	26	4,35	4,71	0,95	2375	0,109	0,152	32,53	21,69	4,35	Zadovoljava
ZY04	132,99	68,33	81,44	3,65	9125	0,146	0,161	132,57	88,38	68,33	Zadovoljava
ZY05	114,99	51,86	70,5	3,25	8125	0,142	0,160	117,28	78,19	51,86	Zadovoljava
ZY06	88,99	49,29	77,66	3,25	8125	0,110	0,152	111,29	83,96	49,29	Zadovoljava
ZY07	146,17	69,07	95,75	3,65	9125	0,160	0,165	135,48	90,32	69,07	Zadovoljava
ZY08	131	47,56	93,34	3,25	8125	0,161	0,165	120,82	80,55	47,56	Zadovoljava
ZY09	152,98	79,33	237,24	4,75	11875	0,129	0,157	167,99	111,99	79,33	Zadovoljava
ZY10	50,66	14,8	23,63	1,7	4250	0,119	0,155	59,18	39,45	14,8	Zadovoljava

5. Prilozi

Oznaka	Sadržaj	Mjerilo
01.	Tlocrt prizemlja, Presjek A-A	1:100
02.	Tlocrt kata, Presjek B-B	1:100
03.	Armatura donje zone	1:50
04.	Armatura gornje zone	1:50
05.	Presjek stubišta	1:10
06.	Oznake pozicija presjeka	1:50
07.	Poprečni presjeci	1:20
08.	Poprečni presjeci	1:20
09.	Iskaz armature	-



Literatura

- [1] Zorislav Sorić: Zidane konstrukcije, 2016.
- [2] Jure Radić: Zidane konstrukcije 1, 2007.
- [3] Tomislav Kišićek, Zorislav Sorić: Betonske konstrukcije 1, 2014.
- [4] Građevinar 10/2020: Pojačanje zida na posmik pomoću FRP-a ili TRM-a
(Tomislav Kišićek, Mislav Stepinac, Tvrtko Renić, Ivan Hafner, Luka Lulić)

Tlocrt prizemlja MJ. 1:100

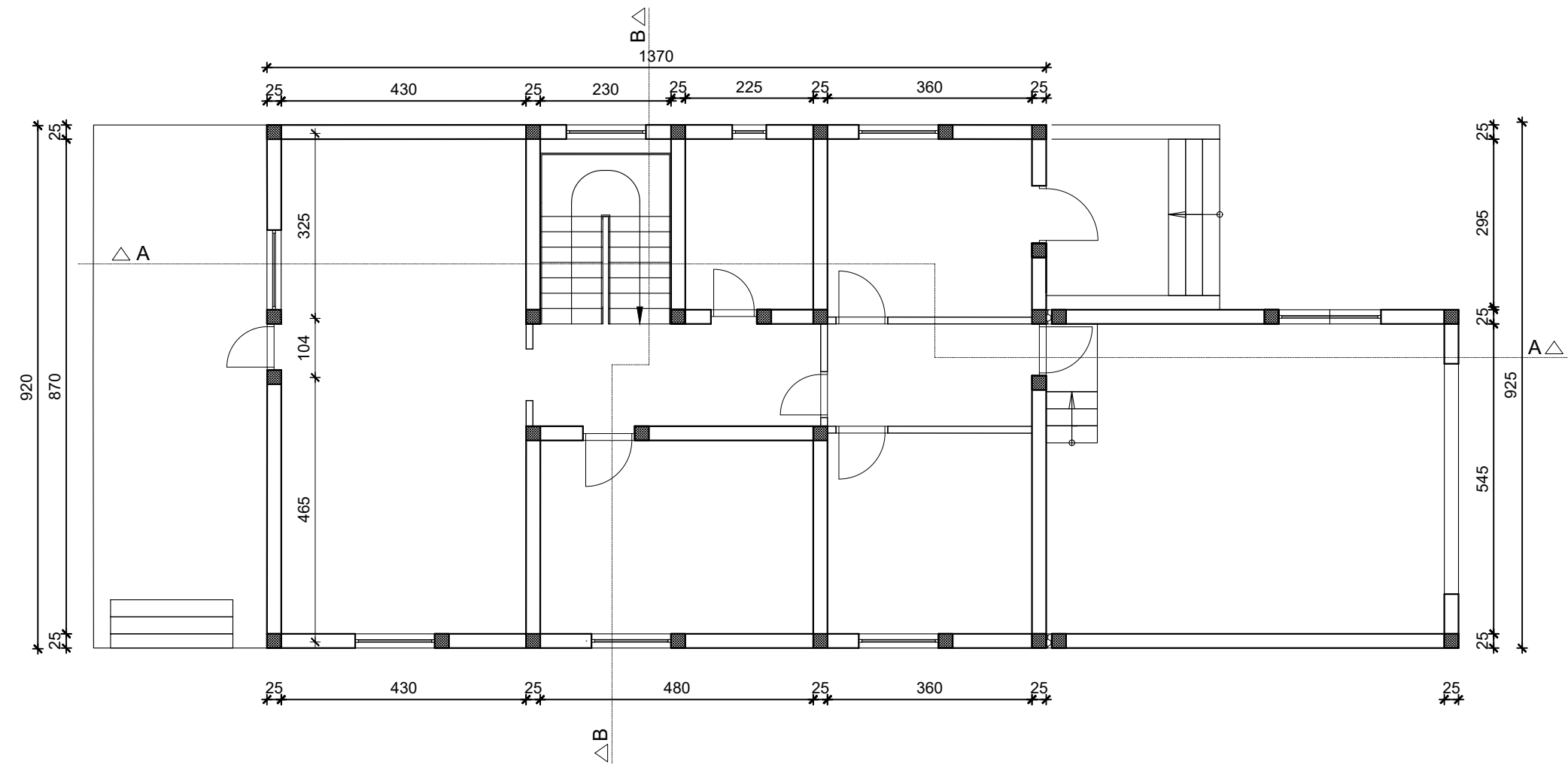

Presjek A-A Mj. 1:100

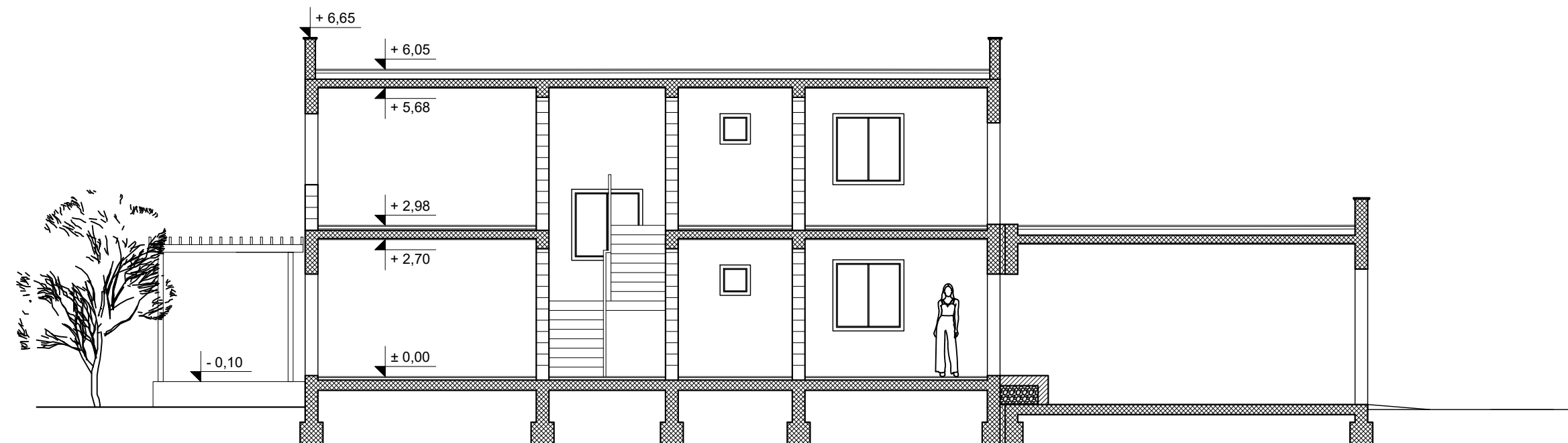

 SVEUČILIŠTE U ZAGREBU GRAĐEVINSKI FAKULTET		
SADRŽAJ NACRTA:		
Tlocrt prizemlja, presjek A-A		
PREDMET	Završni ispit	LOKACIJA:
KOLEGIJ	Numeričko modeliranje konstrukcija	Zagreb
STUDENT	Ivan Radić	MJERILO:
JMBAG	0083222808	1:100
MENTOR	prof.dr.sc. Mladen Meštrović	AK.GOD.:
DATUM	srpanj, 2023.	2022./2023.
BROJ PRILOGA	01.	

Tlocrt kata MJ. 1:100

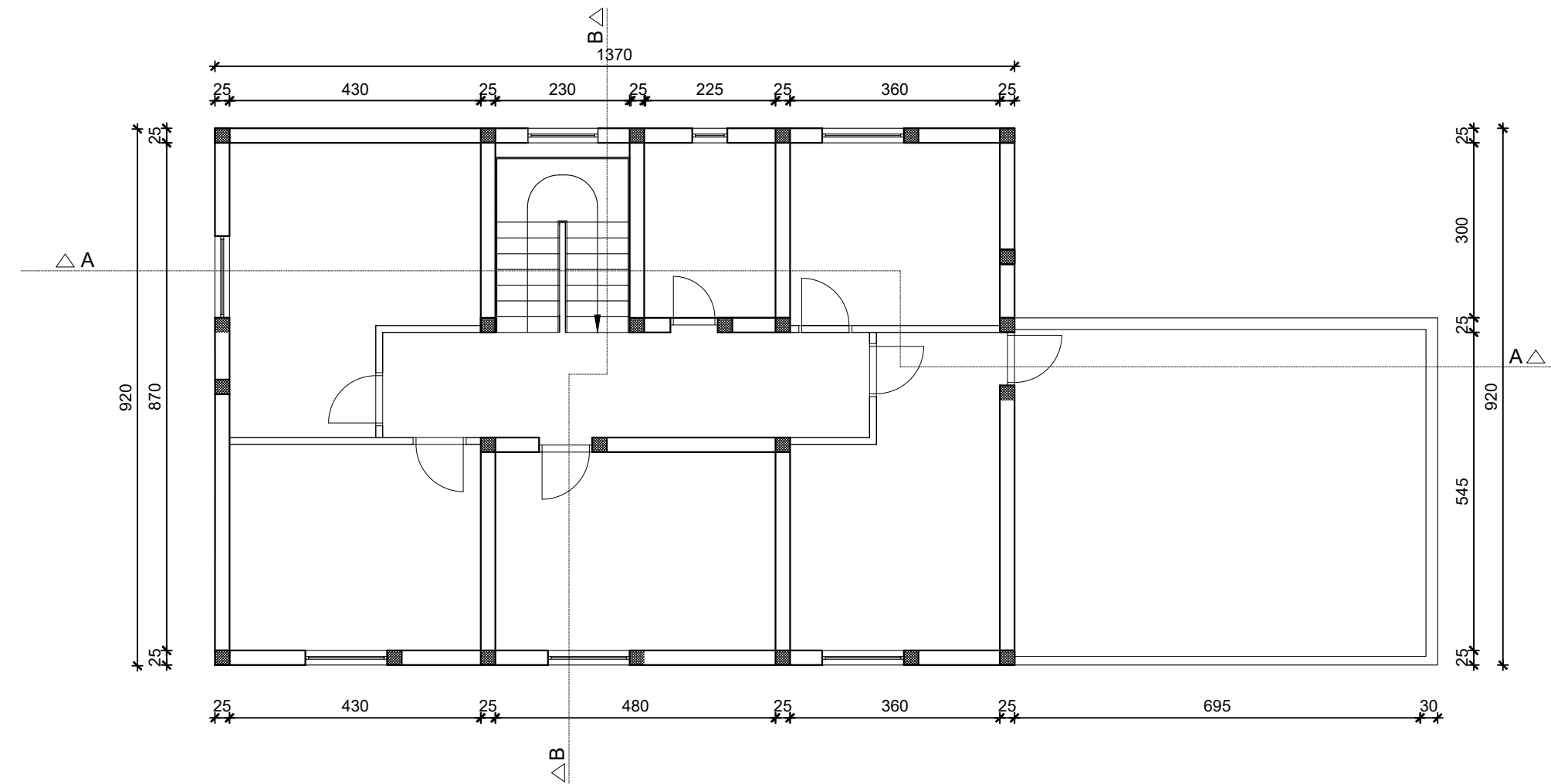

Presjek B-B Mj. 1:100

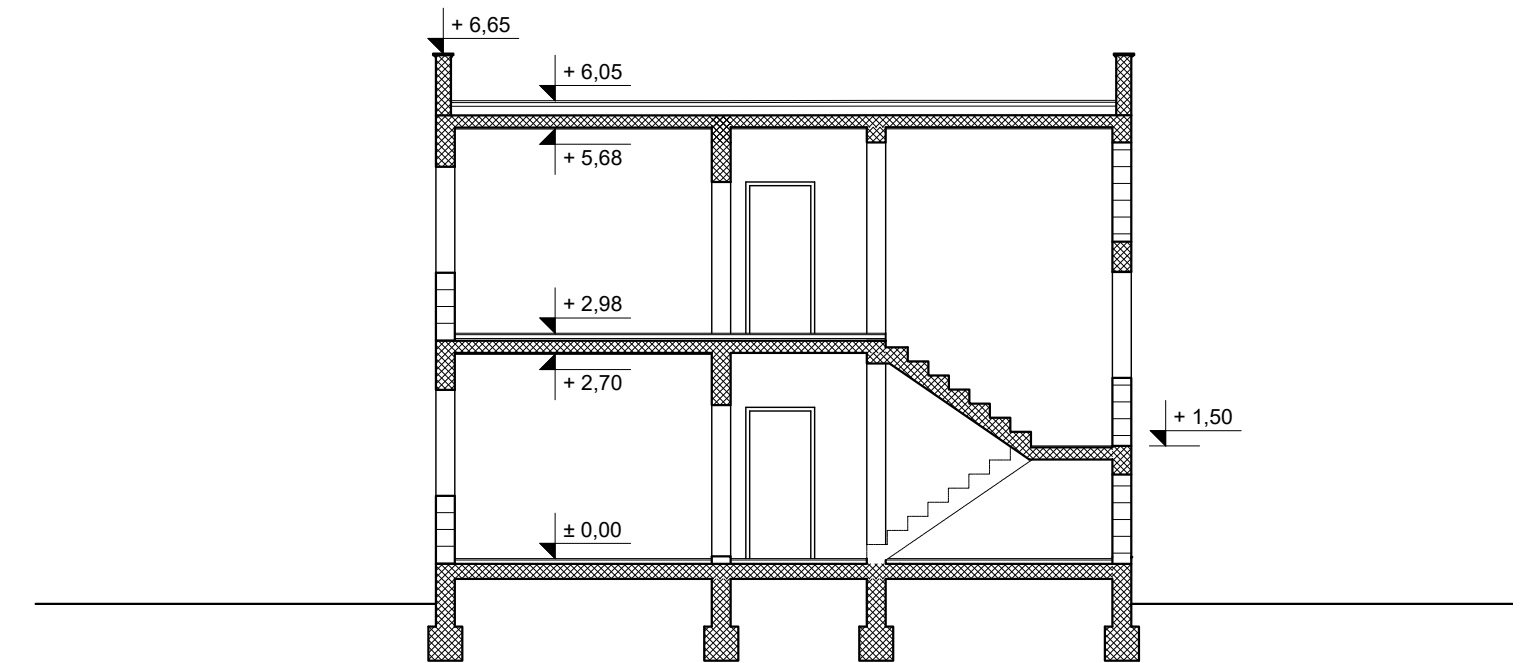

SVEUČILIŠTE U ZAGREBU
GRAĐEVINSKI FAKULTET

SADRŽAJ NACRTA:

Tlocrt kata, presjek B-B

PREDMET	Završni ispit	LOKACIJA:
KOLEGIJ	Numeričko modeliranje konstrukcija	Zagreb
STUDENT	Ivan Radić	MJERILO:
JMBAG	0083222808	1:100
MENTOR	prof.dr.sc. Mladen Meštrović	AK.GOD.:
DATUM	srpanj, 2023.	2022./2023.
BROJ PRILOGA		02.

Armatura donje zone MJ 1:50

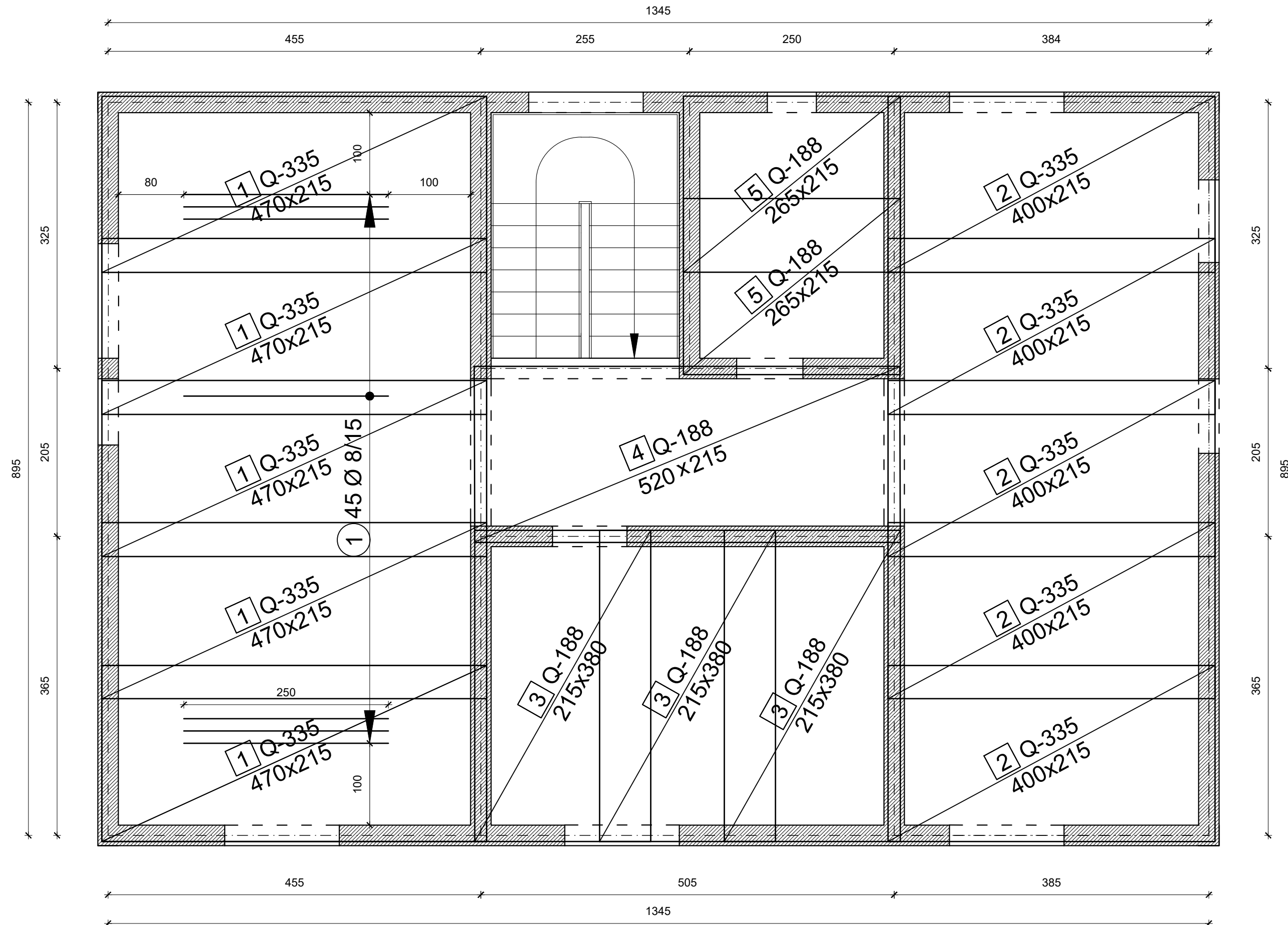

 SVEUČILIŠTE U ZAGREBU GRAĐEVINSKI FAKULTET		
SADRŽAJ NACRTA:		
Armatura donje zone		
PREDMET	Završni ispit	LOKACIJA:
KOLEGIJ	Numeričko modeliranje konstrukcija	Zagreb
STUDENT	Ivan Radić	MJERILO:
JMBAG	0083222808	1:50
MENTOR	prof.dr.sc. Mladen Meštrović	AK.GOD.:
DATUM	srpanj, 2023.	2022./2023.
BROJ PRILOGA		03.

Armatura gornje zone MJ 1:50

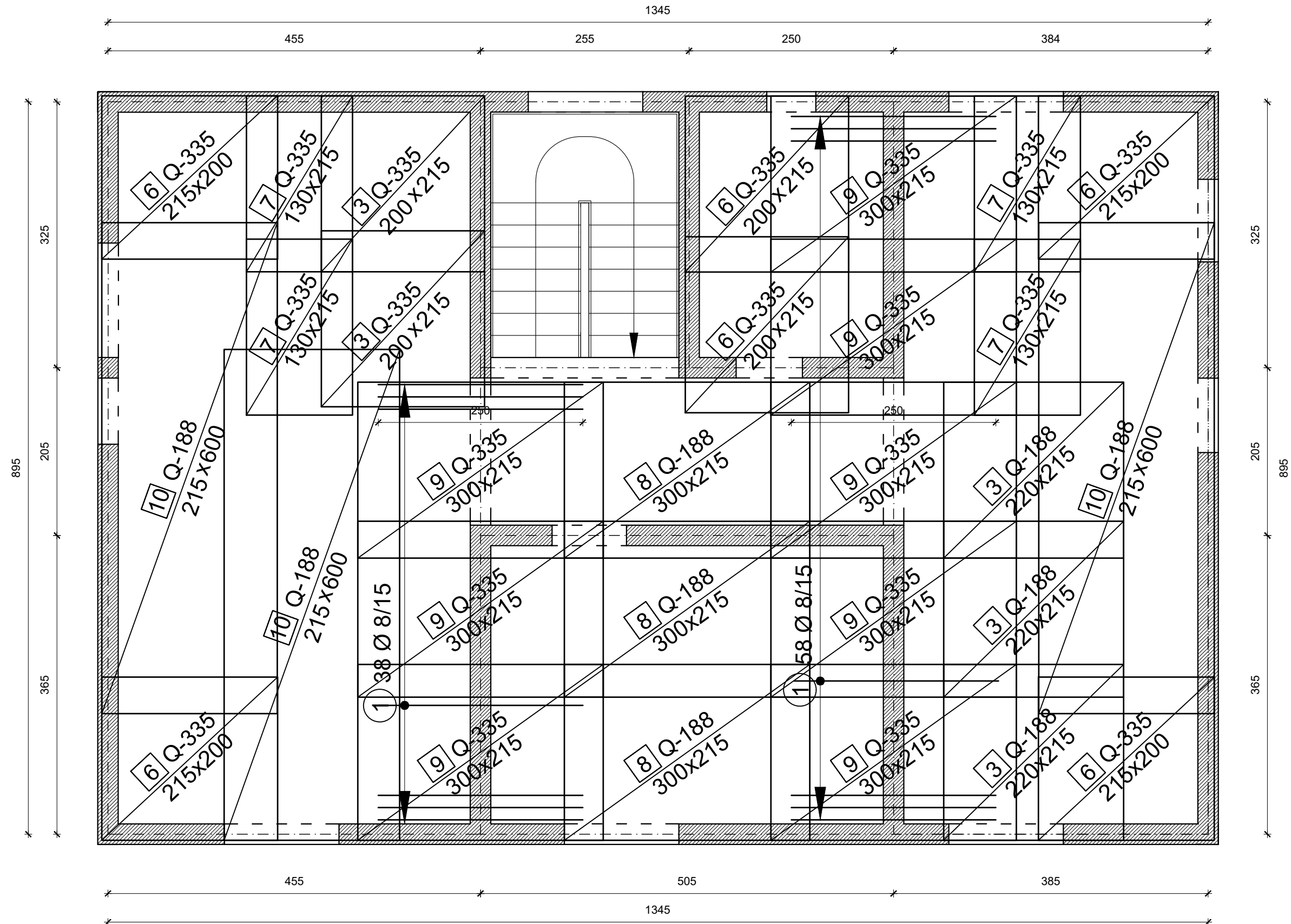

 SVEUČILIŠTE U ZAGREBU GRAĐEVINSKI FAKULTET		
SADRŽAJ NACRTA:		
Armatura gornje zone		
PREDMET	Završni ispit	LOKACIJA:
KOLEGIJ	Numeričko modeliranje konstrukcija	Zagreb
STUDENT	Ivan Radić	MJERILO:
JMBAG	0083222808	1:50
MENTOR	prof.dr.sc. Mladen Meštrović	AK.GOD.:
DATUM	srpanj, 2023.	2022./2023.
BROJ PRILOGA	04.	

PRESJEK STUBIŠTA MJ 1:10

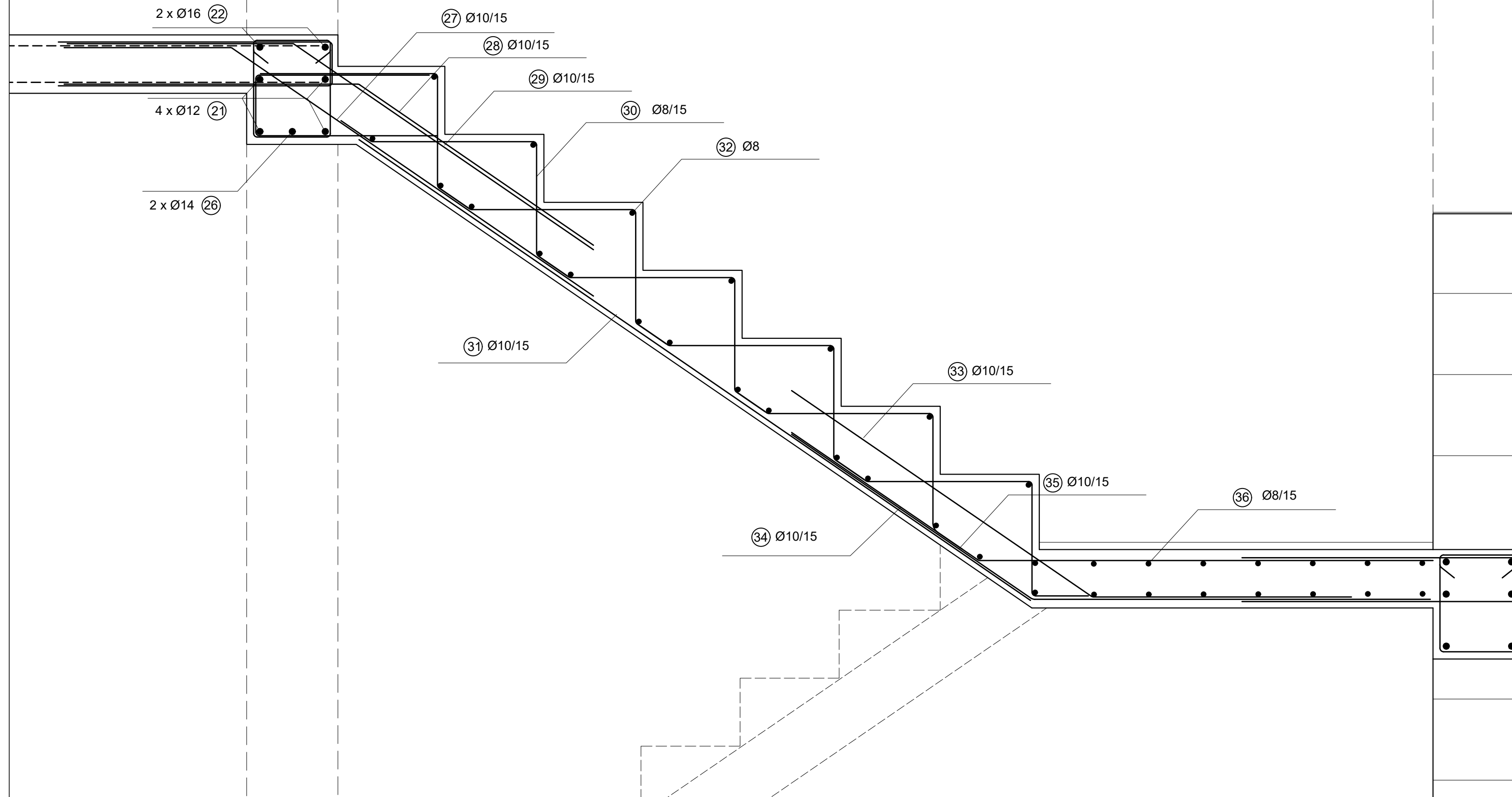

 SVEUČILIŠTE U ZAGREBU GRAĐEVINSKI FAKULTET		
SADRŽAJ NACRTA:		
Presjek stubišta		
PREDMET	Završni ispit	LOKACIJA:
KOLEGIJ	Numeričko modeliranje konstrukcija	Zagreb
STUDENT	Ivan Radić	MJERILO:
JMBAG	0083222808	1:10
MENTOR	prof.dr.sc. Mladen Meštrović	AK.GOD.:
DATUM	srpanj, 2023.	2022./2023.
BROJ PRILOGA	05.	

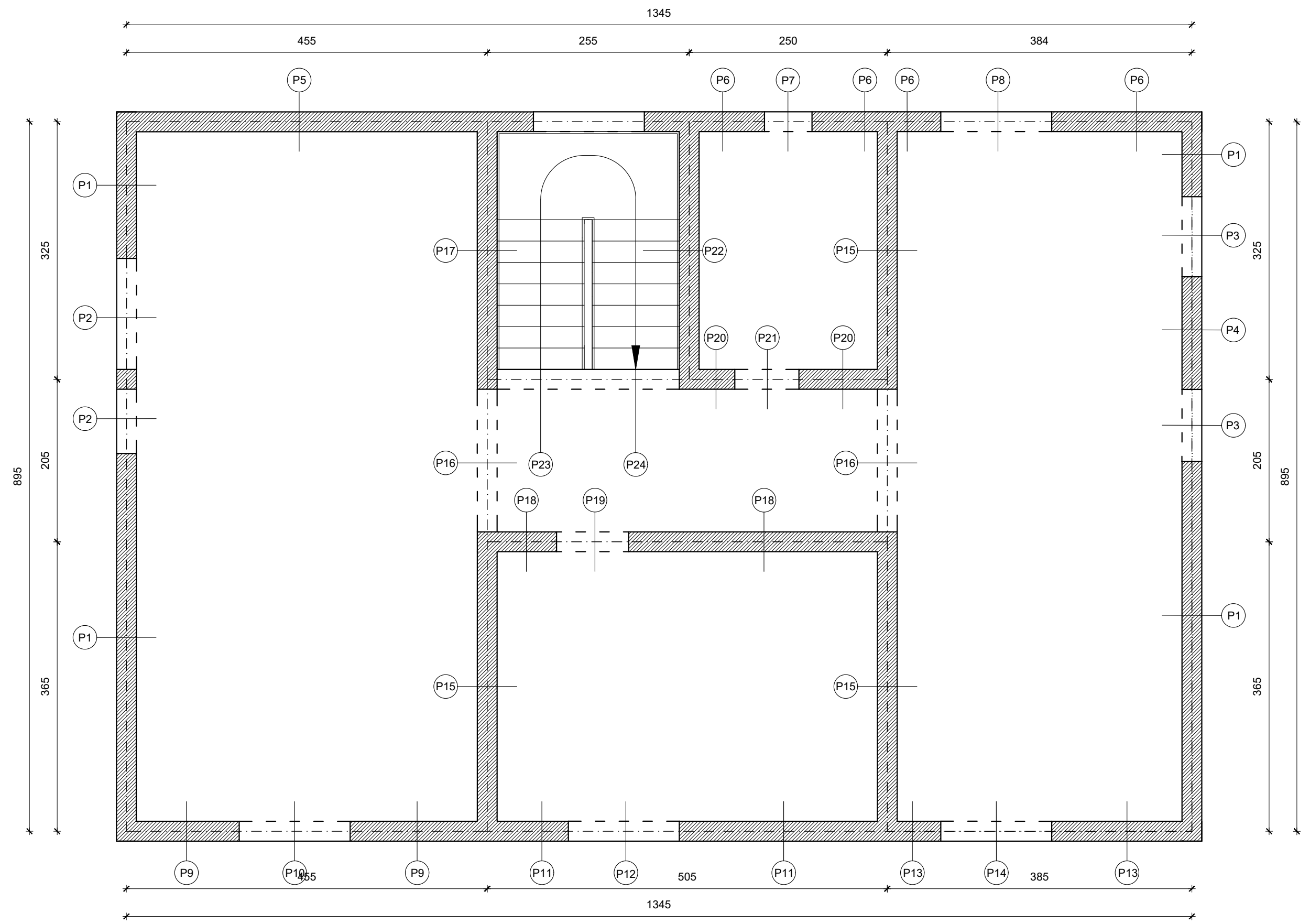

 SVEUČILIŠTE U ZAGREBU GRAĐEVINSKI FAKULTET		
SADRŽAJ NACRTA:		
Oznake pozicija presjeka		
PREDMET	Završni ispit	LOKACIJA:
KOLEGIJ	Numeričko modeliranje konstrukcija	Zagreb
STUDENT	Ivan Radić	MJERILO:
JMBAG	0083222808	1:50
MENTOR	prof.dr.sc. Mladen Meštrović	AK.GOD.:
DATUM	srpanj, 2023.	2022./2023.
BROJ PRILOGA	12.	

Presjek P1 MJ 1:20

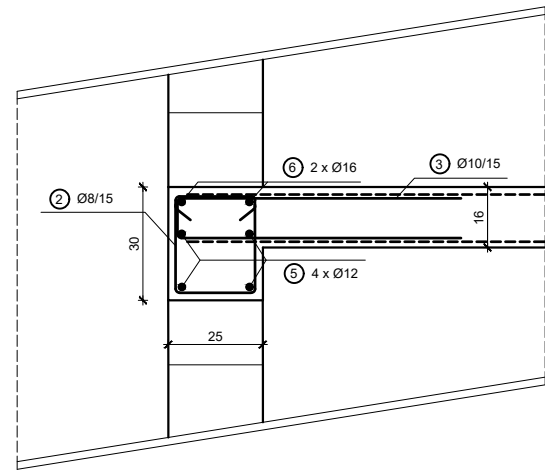

Presjek P2 MJ 1:20

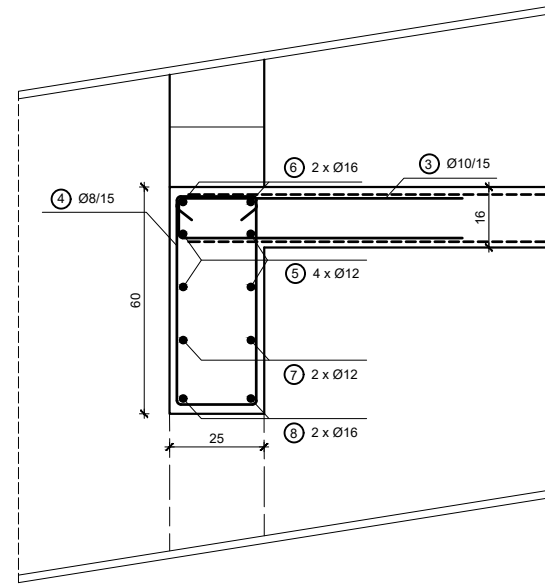

Presjek P3 MJ 1:20

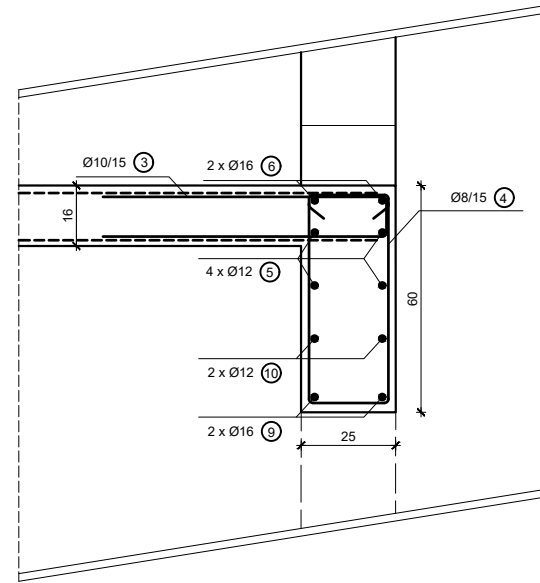

Presjek P4 MJ 1:20

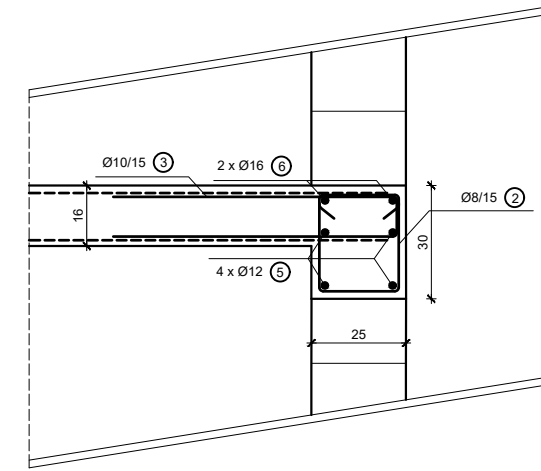

Presjek P5 MJ 1:20

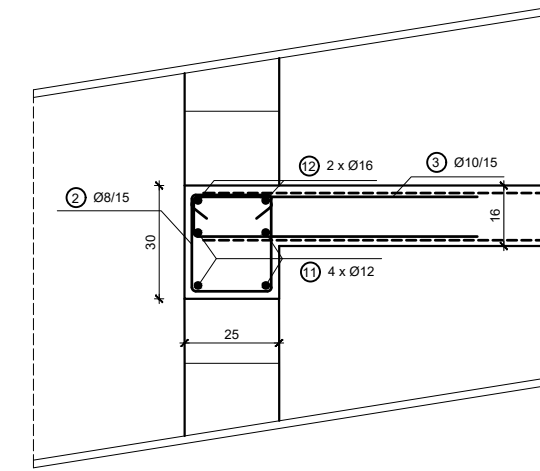

Presjek P6 MJ 1:20

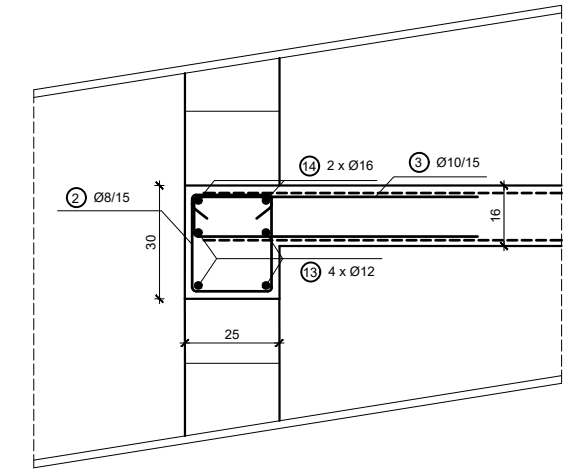

Presjek P7 MJ 1:20

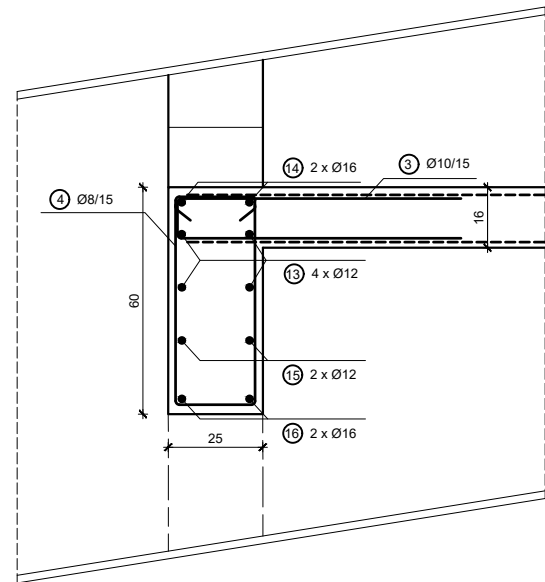

Presjek P8 MJ 1:20

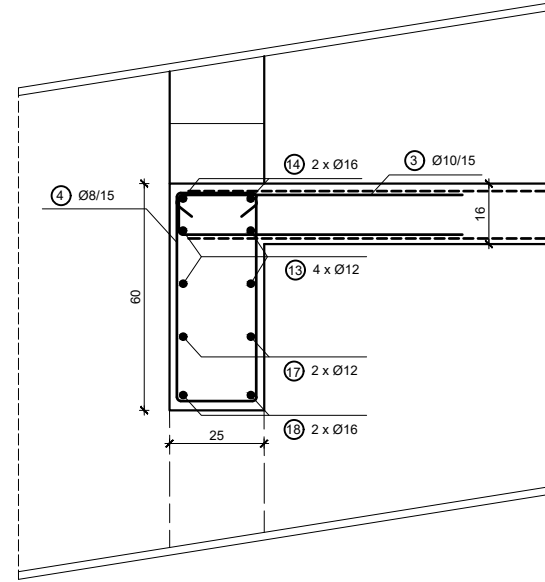

Presjek P9 MJ 1:20

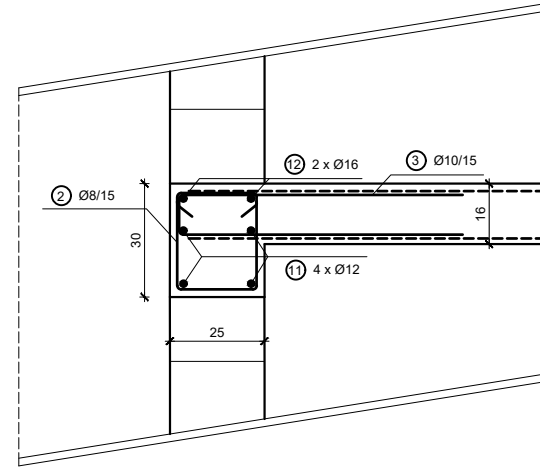

Presjek P10 MJ 1:20

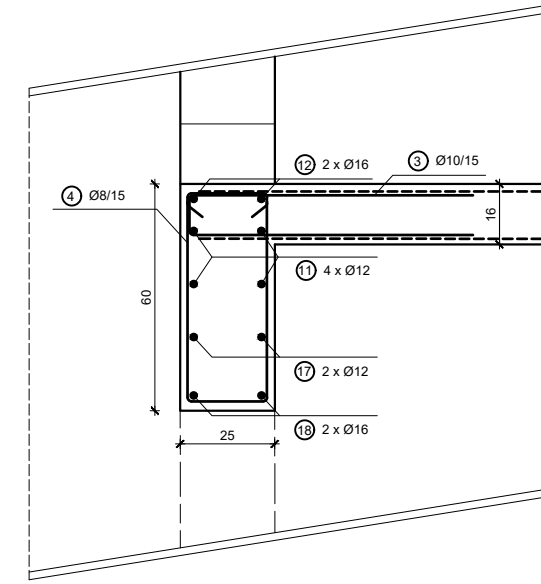

Presjek P11 MJ 1:20

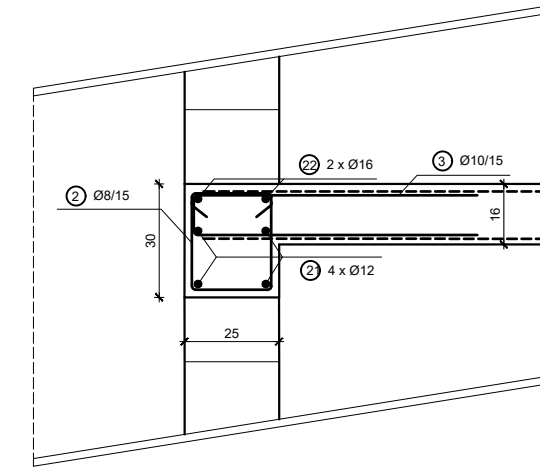

Presjek P12 MJ 1:20

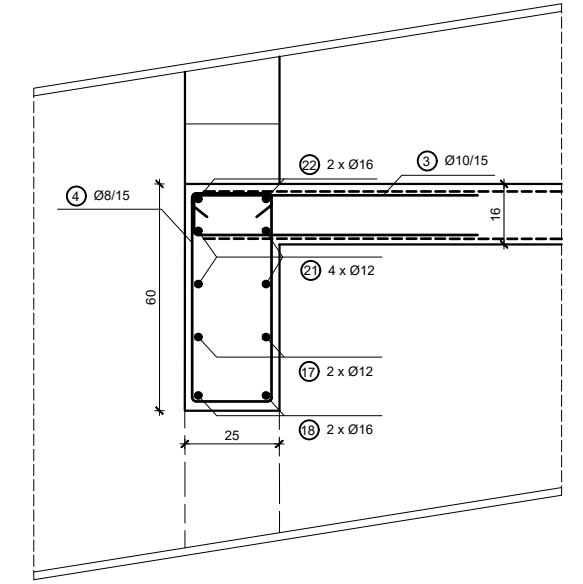

Presjek P13 MJ 1:20

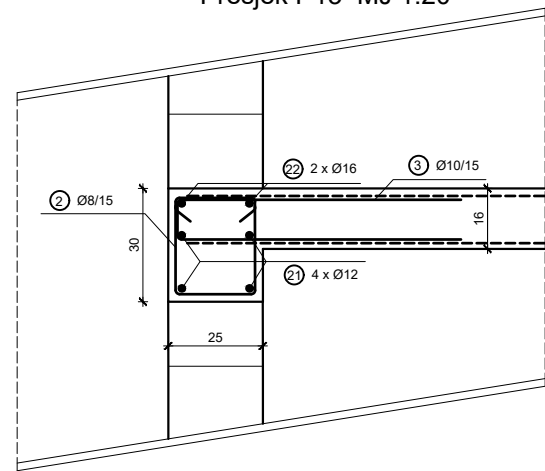

Presjek P14 MJ 1:20

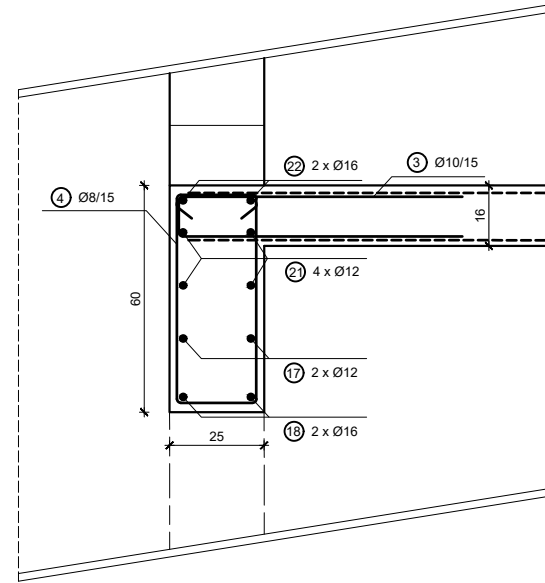

Presjek P15 MJ 1:20

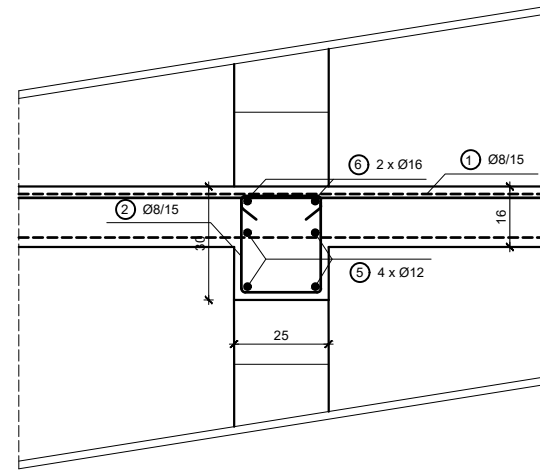

Presjek P16 MJ 1:20

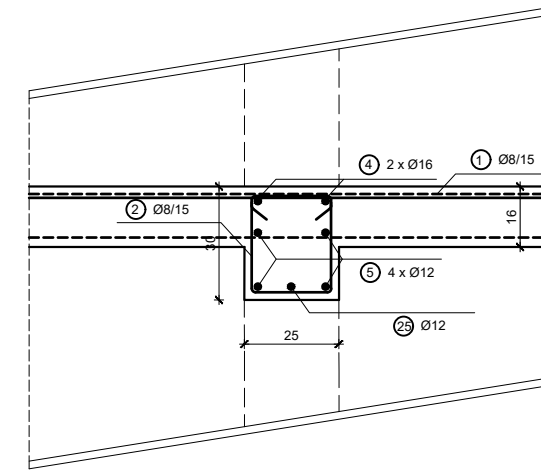

SVEUČILIŠTE U ZAGREBU
GRAĐEVINSKI FAKULTET

SADRŽAJ NACRTA:

Poprečni presjeci

PREDMET	Završni ispit	LOKACIJA:
KOLEGIJ	Numeričko modeliranje konstrukcija	Zagreb
STUDENT	Ivan Radić	MJERILO:
JMBAG	0083222808	1:20
MENTOR	prof.dr.sc. Mladen Meštrović	AK.GOD.:
DATUM	srpanj, 2023.	2022./2023.
BROJ PRILOGA		07.

Presjek P17 MJ 1:20

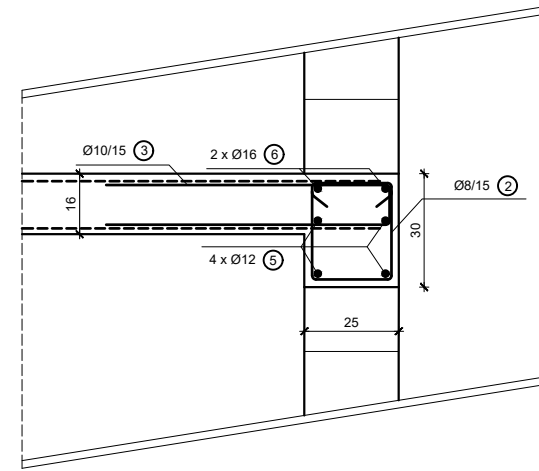

Presjek P18 MJ 1:20

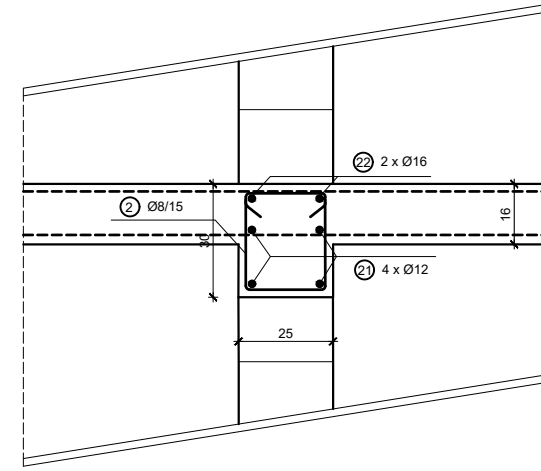

Presjek P19 MJ 1:20

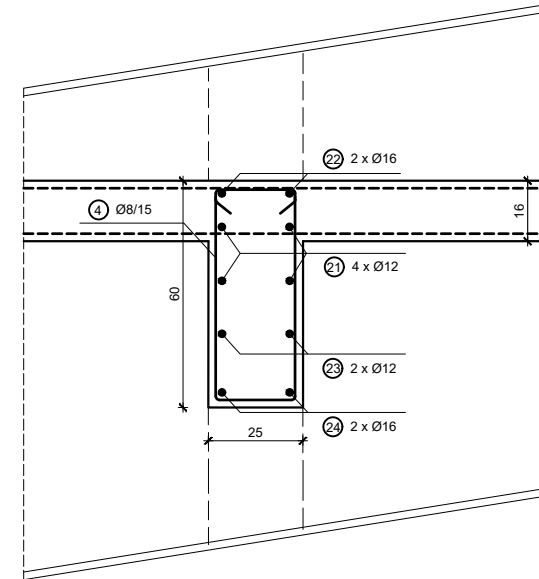

Presjek P20 MJ 1:20

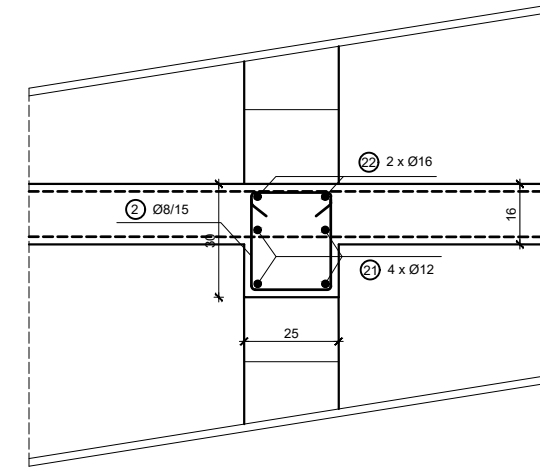

Presjek P21 MJ 1:20

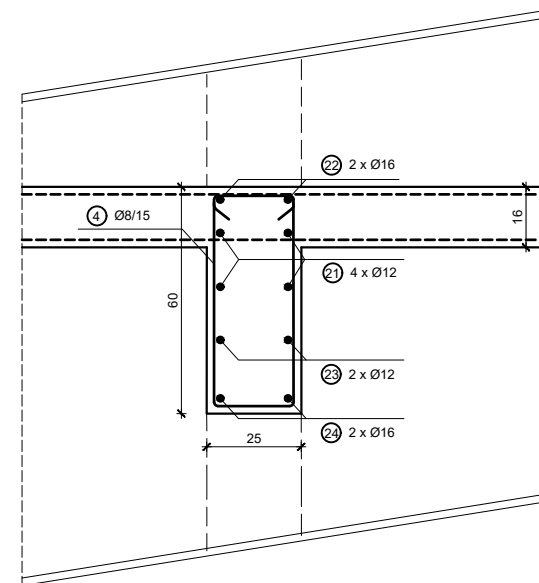

Presjek P22 MJ 1:20

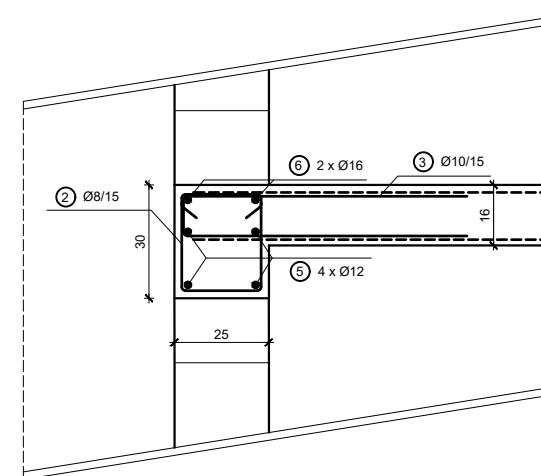

Presjek P23 MJ 1:20

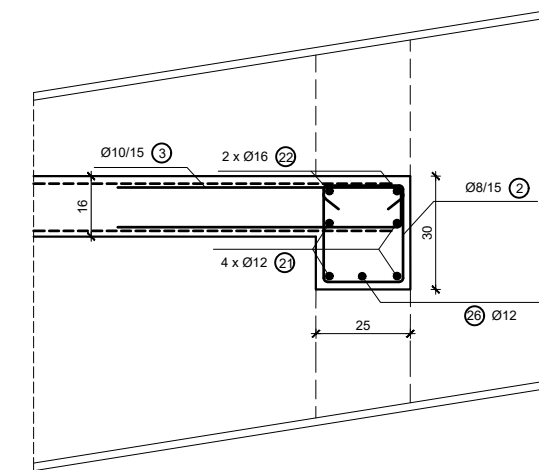

Presjek P24 MJ 1:20

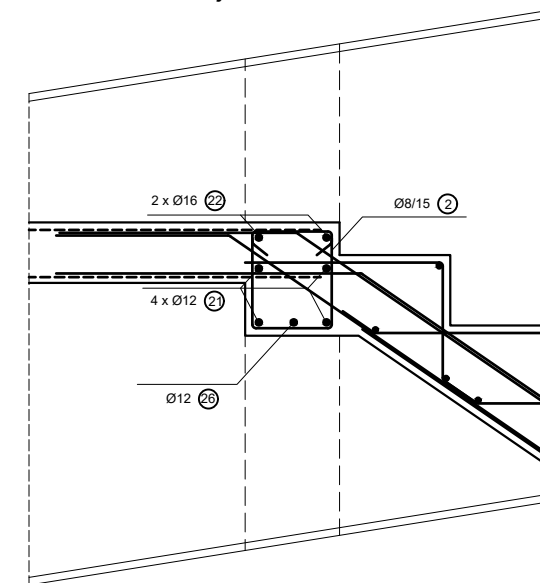





**SVEUČILIŠTE U ZAGREBU
GRAĐEVINSKI FAKULTET**







SADRŽAJ NACRTA:

Poprečni presjeci

PREDMET	Završni ispit	LOKACIJA:
KOLEGIJ	Numeričko modeliranje konstrukcija	Zagreb
STUDENT	Ivan Radić	MJERILO:
JMBAG	0083222808	1:20
MENTOR	prof.dr.sc. Mladen Meštrović	AK.GOD.:
DATUM	srpanj, 2023.	2022./2023.
BROJ PRILOGA		08.

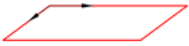

9. Iskaz armature



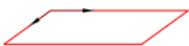



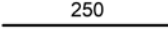
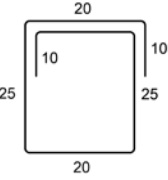
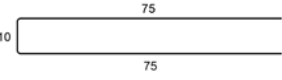
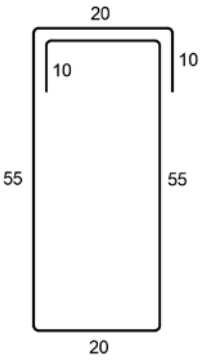
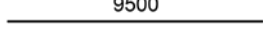
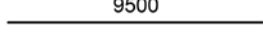
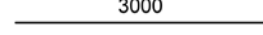
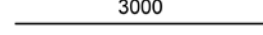
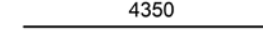
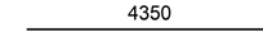
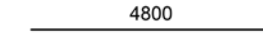
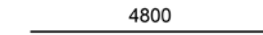
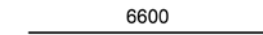
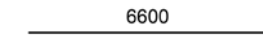

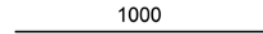
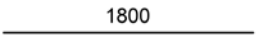
Iskaz mrežaste armature - Donja zona - Čelik B500B				
Poz.	Tip mreže	Oblik	Dimenzije (cm)	Kom.
1	Q-335		470 x 215	5
2	Q-335		400 x 215	5
3	Q-188		215 x 380	3
4	Q-188		520 x 215	1
5	Q-188		265 x 215	2

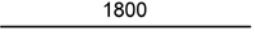
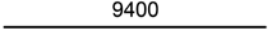
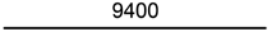
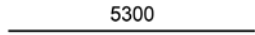
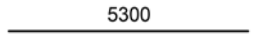

Iskaz mrežaste armature - Gronja zona - Čelik B500B				
Poz.	Tip mreže	Oblik	Dimenzije (cm)	Kom.
6	Q-335		215 x 200	8
7	Q-335		130 x 215	4
8	Q-188		300 x 215	3
9	Q-335		300 x 215	6
10	Q-188		215 x 600	3
11	Q-188		220 x 215	3

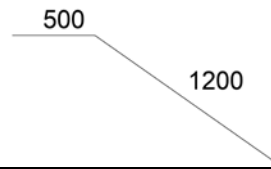
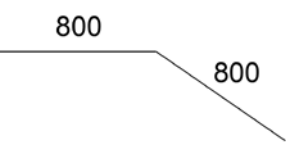
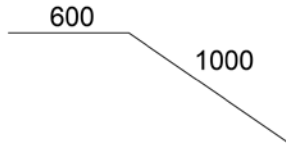
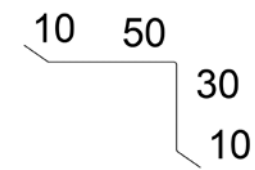
Iskaz mrežaste armature - Ukupan broj mreža - Čelik B500B					
Tip mreže	Oblik	Dimenzije (cm)	Kom.	kg/m ²	Masa (kg)
Q-335		215 x 600	15	5,45	1054,58
Q-188		215 x 600	9	3,06	355,27
Ukupna masa:					1409,84 kg

Iskaz rebraste armature Čelik B500B

Poz.	Oblik (cm)	Φ [mm]	Duljina [m]	Kom.
1		8	2,5	141
2		8	1,1	295
3		10	1,6	295
4		10	9	126
5		12	9,5	16
6		16	9,5	8
7		12	3	2
8		16	3	2
9		16	4,35	2
10		12	4,35	2
11		12	4,8	8
12		16	4,8	4
13		12	6,6	4
14		16	6,6	2
15		12	1	2
16		16	1	2
17		12	1,8	8

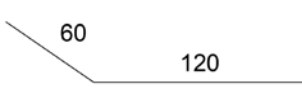
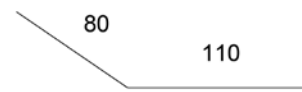
18		16	1,8	8
19		12	9,4	2
20		12	9,4	2
21		12	5,3	8
22		16	5,3	4
23		12	1,3	4
24		16	1,3	4
25		12	2,3	1
26		12	4,8	1
27		10	1,7	7
28		10	1,6	7
29		10	1,6	7
30		8	1	7
31		10	2,2	7
32		8	1,1	20
33		10	1,7	7

34		10	1,8	7
35		10	1,9	7
36		8	2,3	16

Ukupna masa rebraste armature	
Φ [mm]	Masa (kg)
8	292
10	1074
12	305
16	269
Σ	1939,71