

Proračun konstrukcije stambene građevine

Rinkovec, Tino

Undergraduate thesis / Završni rad

2023

Degree Grantor / Ustanova koja je dodijelila akademski / stručni stupanj: **University of Zagreb, Faculty of Civil Engineering / Sveučilište u Zagrebu, Građevinski fakultet**

Permanent link / Trajna poveznica: <https://um.nsk.hr/um:nbn:hr:237:055792>

Rights / Prava: [In copyright](#)/[Zaštićeno autorskim pravom.](#)

Download date / Datum preuzimanja: **2024-09-08**

Repository / Repozitorij:

[Repository of the Faculty of Civil Engineering,
University of Zagreb](#)



SVEUČILIŠTE U ZAGREBU
GRAĐEVINSKI FAKULTET ZAGREB

ZAVRŠNI RAD

Tino Rinkovec

SVEUČILIŠTE U ZAGREBU
GRAĐEVINSKI FAKULTET ZAGREB

ZAVRŠNI RAD
PRORAČUN KONSTRUKCIJE
STAMBENE GRAĐEVINE

Mentor:
prof. dr. sc. Mladen Meštrović

Student:
Tino Rinkovec

Zagreb, 2023.

UNIVERSITY OF ZAGREB
FACULTY OF CIVIL ENGINEERING

FINAL PAPER
STRUCTURAL ANALYSIS OF
RESIDENTIAL BUILDING

Mentor:
prof. dr. sc. Mladen Meštrović

Student:
Tino Rinkovec

Zagreb, 2023.



TEMA ZAVRŠNOG ISPITA

Ime i prezime studenta: **Tino Rinkovec**

JMBAG: **0082064609**

Završni ispit iz predmeta: **Numeričko modeliranje konstrukcija**

Naslov teme
završnog ispita:

HR

**Proračun konstrukcije stambene
građevine**

ENG

**Structural analysis of residential
building**

Opis teme završnog ispita:

definirati konstrukciju, analiza opterećenja, numerički model konstrukcije, proračun unutarnjih sila, dimenzioniranje konstrukcije, nacrt armature karakterističnih elemenata konstrukcije

Datum: **27.4.2023.**

Komentor: _____
(Ime i prezime komentora)

Mentor: **Mladen Mestrovic**
(Ime i prezime mentora)

(Potpis mentora)

SAŽETAK

Zadatak ovog rada je proračun višekratne pravilne stambene građevine u Zagrebu, tlocrtnih dimenzija 6.89 m i 14.42 m. Ovaj rad obuhvaća analizu opterećenja, izradu numeričkog modela konstrukcije, proračun unutarnjih sila, dimenzioniranje konstrukcije i izradu nacrtu armature karakterističnih elemenata konstrukcije. Proračun je temeljen na EUROCODE- u. 3D model konstrukcije, proračun i dimenzioniranje karakterističnih elemenata provedeno je u programu RFEM 6. Vertikalni i horizontalni serklaži nisu modelirani kao zasebni elementi, već su modelirani u sklopu zida i zajedno čine jedinstveni plošni element. Betonska ploče su modelirane kao plošni elementi slobodno oslonjeni na zidove. Grede i stupovi modelirani su kao štapni elementi. Na dno zidova prizemlja postavljeni su linijske ležajevi. Ukupna potresna sila raspodijeljena je po etažama i nanesena kao jednoliko opterećenje po površinama odgovarajućih ploča.

ABSTRACT

The task of this final paper is to analyze the structure of the residential building in Zagreb. Layout dimensions of the building are 6.89m and 14.42m. This final paper consists of load analysis, numerical construction model, calculation of internal forces, dimensioning of the characteristic elements and layouts of the characteristic elements. Calculation is based on the Eurocode. 3D model of the construction and dimensioning of the structure was carried out in the RFEM 6. Confining beams and columns are not modeled as separate elements but are modeled as part of the wall and together form a single surface element. Concrete slabs are modeled as flat elements freely supported on the walls. Beams and columns are modeled as rod elements. Line support is placed at the bottom of the ground floor walls. The total seismic force is distributed over the floors and applied as a uniform load on the surfaces of each slab.

SADRŽAJ

1. TEHNIČKI OPIS	1. str.
2. PRIKAZ NUMERIČKOG MODELA KONSTRUKCIJE	2. str.
3. ANALIZA OPTEREĆENJA NA KONSTRUKCIJU	5.str.
3.1. Vlastita težina (stalno opterećenje).....	5. str.
3.2. Dodatno stalno opterećenje	5. str.
3.3. Uporabno opterećenje	6. str.
3.4. Opterećenje snijegom	6. str.
3.5. Opterećenje vjetrom	6. str.
3.6. Potresno opterećenje.....	7. str.
4. KOMBINACIJE OPTEREĆENJA.....	13. str.
5. DIMENZIONIRANJE	14. str.
5.1. Unutarnje sile ploče	14. str.
5.2. Potrebna armature ploče	16. str.
5.3. Potrebna armatura greda	18. str.
5.4. Prikaz zidova i pripadnih unutarnjih sila.....	19. str.
5.5. Provjera nosivosti zida.....	33. str.
6. LITERATURA.....	37. str.
7. PRILOZI	38. str.

1. TEHNIČKI OPIS

Tlocrtne dimenzije građevine smještene u Zagrebu su 6.89 m x 14.42 m. Građevina se sastoji od 3 etaže (prizemlje, 1. kat i potkrovlje). Visina prizemlja iznosi 2.65 m, visina 1. kata iznosi 2.61 m i visina potkrovlja iznosi 3.00 m. Zidovi ove stambene građevine izvedeni su od opeke, a karakteristični elementi omeđenog zida izvedeni su od betona. Korištena je opeka marke Porotherm 25 - 38 debljine 0.25m i mort opće namjene M10, beton C30/37 i betonski čelik B500B. Zidana nosiva konstrukcija ukrućena je horizontalnim i vertikalnim armiranobetonskim serklažima i nadvojima. Pregradni zidovi izvedeni su od pregradne blok opeke debljine 0.15 m. Statički proračun i dimenzioniranje karakterističnih elemenata provedeni su za mjerodavne kombinacije sljedećih djelovanja: vlastita težina, uporabno opterećenje, opterećenje snijegom i potresno opterećenje.

2. PRIKAZ NUMERIČKOG MODELA KONSTRUKCIJE

Južna i istočna strana

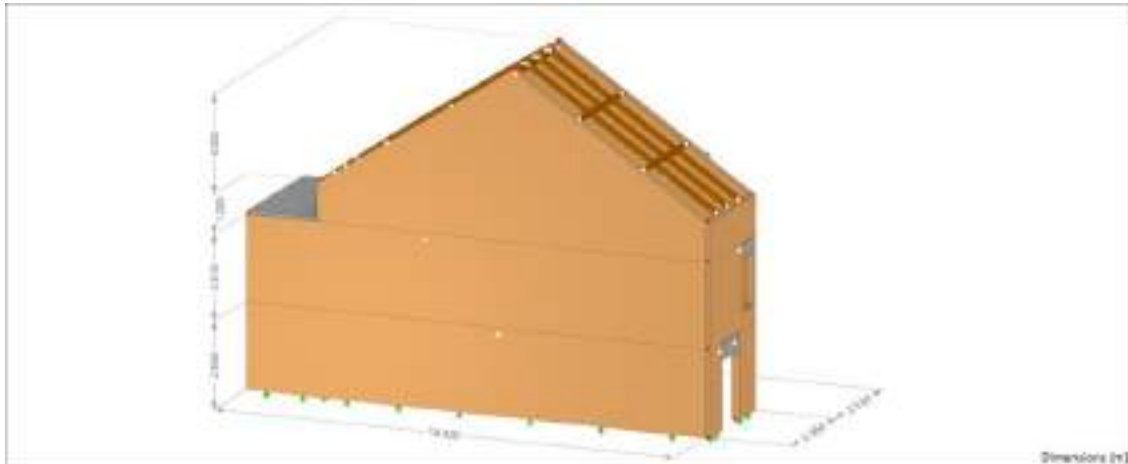

Sjeverna i istočna strana



Sjeverna i zapadna strana

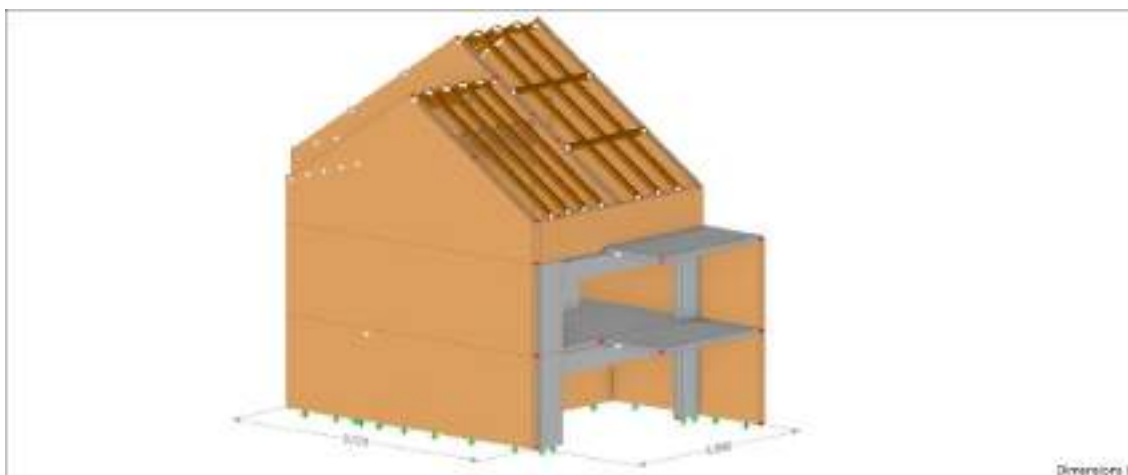

Prizemlje

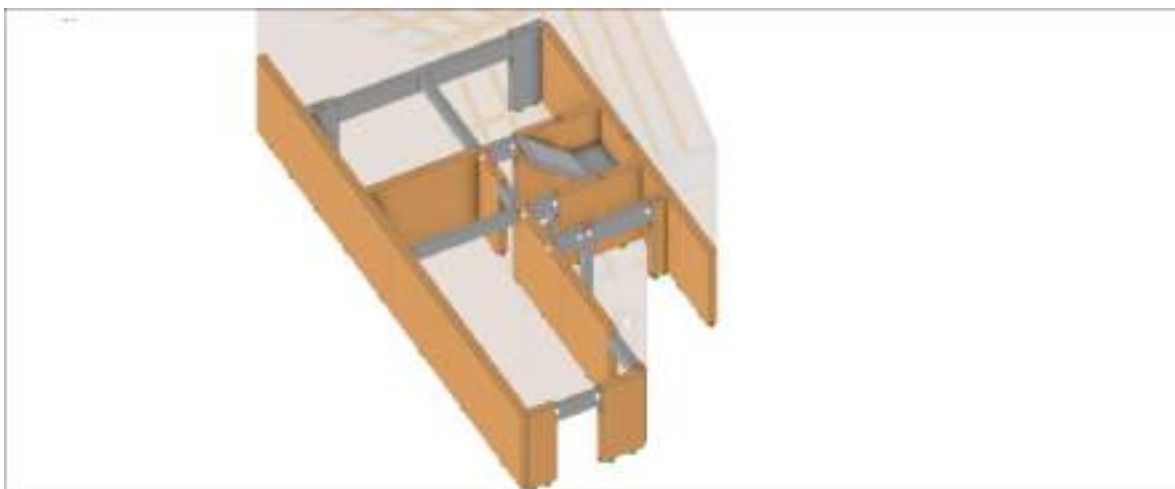

Prvi kat



Potkrovlje (južna i istočna strana)



Potkrovlje (sjeverna i zapadna strana)

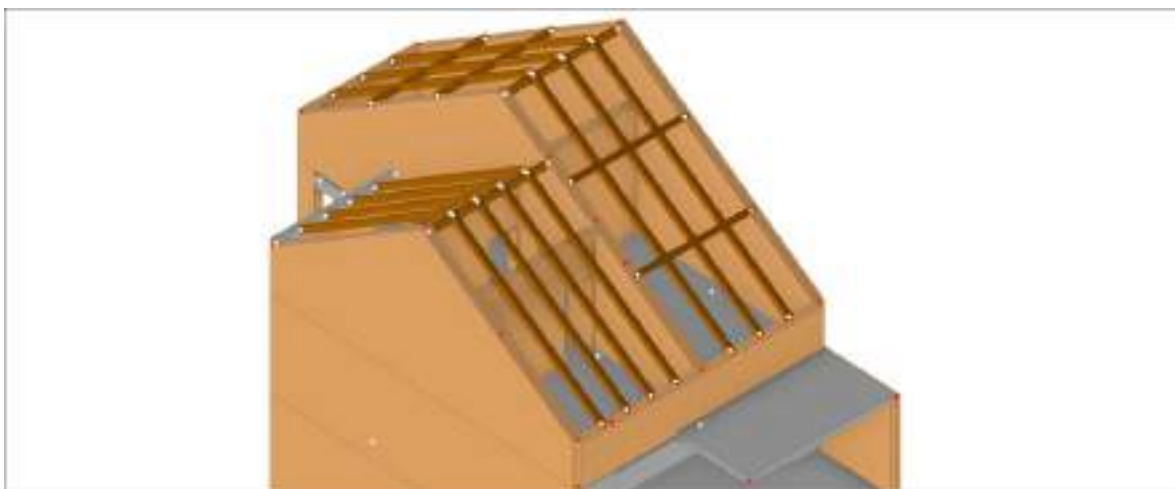

3. ANALIZA OPTEREĆENJA NA KONSTRUKCIJU

3.1. Vlastita težina (stalno opterećenje)

Software Dlubal RFEM 6 u proračun automatski uzima vlastitu težinu konstrukcije.

3.2. Dodatno stalno opterećenje

Ploča – međukatna konstrukcija

Finalna obloga 2 cm ($0.02 \cdot 8$) =0.16 kN/m²

Estrih 6 cm ($0.06 \cdot 22$) =1.32 kN/m²

Polistiren 4 cm ($0.04 \cdot 15$) =0.60 kN/m²

Žbuka ($0.05 \cdot 18$) =0.9 kN/m²

Ukupno dodatno stalno..... $\Sigma = 3.0$ kN/m²

Krov

Glineni krovni crijep 4 cm ($0.04 \cdot 9.75$) =0.39 kN/m²

Mineralna vuna ($0.12 \cdot 16.33$) =1.96 kN/m²

Gipskartonska ploča 1.25 cm ($0.0125 \cdot 6.72$) =0.084 kN/m²

Ukupno dodatno stalno..... $\Sigma = 2.4$ kN/m²

Balkon

Finalna obloga 2 cm ($0.02 \cdot 8$) =0.16 kN/m²

Estrih 6 cm ($0.06 \cdot 22$) =1.32 kN/m²

Polistiren 4 cm ($0.04 \cdot 15$) =0.60 kN/m²

Mineralna vuna ($0.12 \cdot 16.33$) =1.96 kN/m²

Žbuka ($0.05 \cdot 18$) =0.9 kN/m²

Polimer cementno ljepilo ($0.005 \cdot 15$) = 0.075 kN/m²

Ukupno dodatno stalno..... $\Sigma = 5.0$ kN/m²

3.3. Uporabno opterećenje

Uporabno opterećenje (EN 1992)

Uporabno opterećenje za međukatne konstrukcije..... $q = 2.5 \text{ kN/m}^2$

Uporabno opterećenje za stubište..... $q = 2.5 \text{ kN/m}^2$

Uporabno opterećenje za balkone..... $q = 4.0 \text{ kN/m}^2$

3.4. Opterećenje snijegom

Objekt se nalazi u III. području djelovanja snijega $\rightarrow s'_k = 1.25 \text{ kN/m}^2$

Krov građevine izveden je pod nagibom od $27^\circ \rightarrow \mu_i = 0.80$

Koeficijent izloženosti, uzima u obzir teže uvjete puhanja vjetra $\rightarrow C_e = 1.00$

Toplinski koeficijent zbog zagrijavanja zgrade, uzima u obzir termičku izolaciju krova $\rightarrow C_t = 1.00$

Karakteristično opterećenje snijegom:

$$s_k = \mu_i \cdot C_e \cdot C_t \cdot s'_k = 0.80 \cdot 1.00 \cdot 1.00 \cdot 1.25 = 1 \text{ kN/m}^2$$

3.5. Opterećenje vjetrom

Nadmorska visina građevine $\rightarrow a_s = 122.00 \text{ m}$

Osnovna poredbena brzina vjetra za II. područje (iz karte vjetrova) $\rightarrow v_{\text{reff},0} = 20 \text{ m/s}$

Poredbena brzina vjetra:

$$c_{\text{ALT}} = 1 + 0.001 \cdot a_s = 1.12$$

$$c_{\text{DIR}} = 1.00$$

$$c_{\text{TEM}} = 1.00$$

$$v_{\text{ref}} = c_{\text{ALT}} \cdot c_{\text{DIR}} \cdot c_{\text{TEM}} \cdot v_{\text{reff},0} = 1.12 \cdot 1.00 \cdot 1.00 \cdot 20 = 22.40 \text{ m/s}$$

Koeficijent izloženosti za III. kategoriju terena:

Faktor izloženosti za vanjski vjetar $\rightarrow c_e(z = 10.40 \text{ m}) = 1.75$

Faktor izloženosti za unutarnji vjetar $\rightarrow c_i(z = 10.40 \text{ m}) = 1.75$

Koeficijent vanjskog tlaka za vertikalne zidove pravokutnih niskih građevina $\rightarrow c_{pe} = 0.80$

Poredbeni tlak vjetra: $q_{ref} = \frac{\rho}{2} \cdot v_{ref}^2 = \frac{1}{2} \cdot 1.25 \cdot 22.4^2 = 313.60 \text{ N/m}^2 = 0.31 \text{ kN/m}^2$

Pritisak vjetra na vanjsku površinu: $w_e = q_{ref} \cdot c_e(z_e) \cdot c_{pe} = 0.31 \cdot 1.75 \cdot 0.8 = 0.43 \text{ kN/m}^2$

Ukupna sila od vjetra:

$$\mathbf{F_w = w_e \cdot A = 0.43 \cdot 114.31 = 49.15 \text{ kN}}$$

3.6. Potresno opterećenje

Ukupna proračunska potresna sila na građevinu $\rightarrow F_{bd} = S_d(T_1) \cdot \frac{W}{g} \cdot \lambda$

Za vrstu tla B očitano:

$$\lambda = 1$$

$$T_1 = 0.5 \text{ sec}$$

$$S = 1.2$$

$$T_B = 0.15 \text{ s}$$

$$T_C = 0.5 \text{ s}$$

$$T_D = 2.0 \text{ s}$$

$$S_d(T_1) = a_g \cdot S \cdot \frac{2.5}{q}$$

$$a_g = 0.243g$$

Faktor ponašanja:

$$q = q_0 \cdot k_w \geq 1.5$$

$$k_w = 1,0$$

$$q = 2,5$$

$$S_d(T_1) = 0.243 \cdot 9.81 \cdot 1.2 \cdot \frac{2.5}{2.5} = 2,86$$

Faktor važnosti:

$$\Upsilon = 1.0$$

Vrijednosti horizontalnih ubrzanja tla za povratni period 475 g:



Težina konstrukcije

Prizemlje

$$G_{prizemlje} = G_{zid} + G_{pl} + G_{sloj}$$

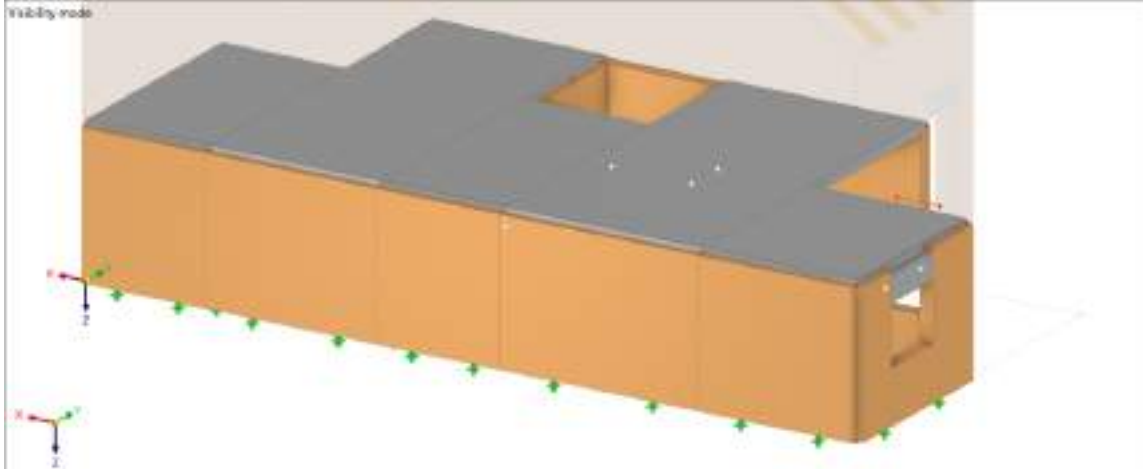

Information About All Selected Objects

Area of surfaces	A	198.752	m ²
Length of members	L	19.765	m
Surface of coating	S	455.711	m ²
Volume	V	46.621	m ³
Mass	M	69.560	t

$$G_{zid} + G_{pl} + G_{stubište} = 68.975 \text{ t} \rightarrow 69.560 \text{ t} \cdot 9.81 = 682.38 \text{ kN}$$

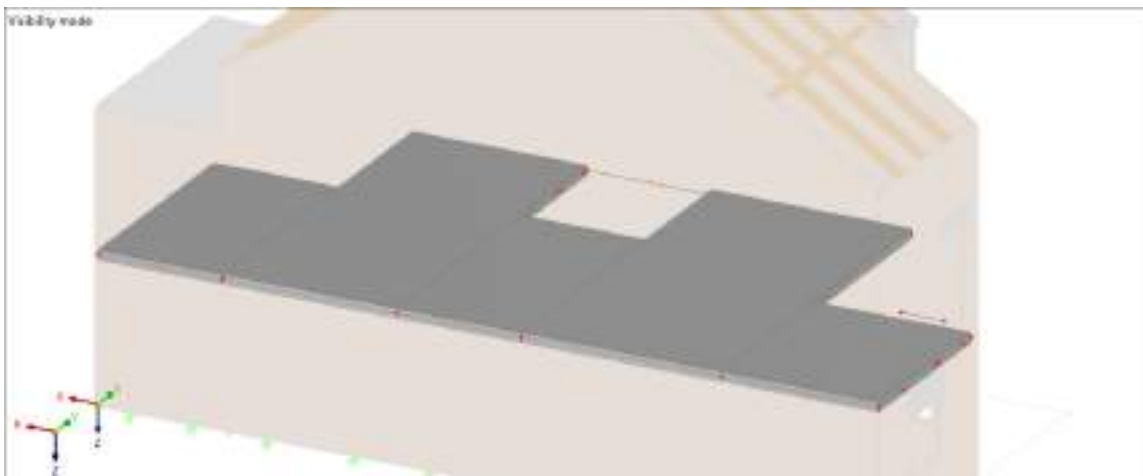

Information About Surfaces

Area of surfaces	A	77.168	m ²
------------------	---	--------	----------------

$$G_{sloj} = 67.508 \text{ m}^2 \cdot 3.0 \text{ kN/m}^2 + 9.66 \text{ m}^2 \cdot 5.0 \text{ kN/m}^2 = 250.82 \text{ kN}$$

$$G_{prizemlje} = G_{zid} + G_{pl} + G_{stubište} + G_{grede i nadvoja} + G_{sloj} = 682.38 + 250.82 = 933.20 \text{ kN}$$

Prvi kat

$$G_{prvi\ kat} = G_{zid} + G_{pl} + G_{sloj}$$

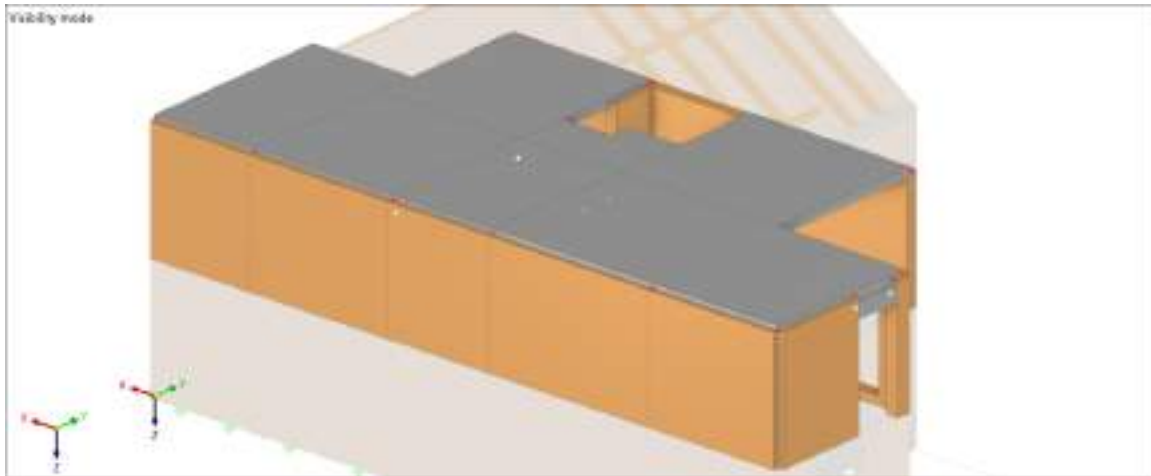

Information About All Selected Objects			
Area of surfaces	A	184.513	m ²
Length of members	L	19.160	m
Surface of coating	S	412.016	m ²
Volume	V	42.637	m ³
Mass	M	66.798	t

$$G_{zid} + G_{pl} + G_{stubište} = 66.715\ t \rightarrow 66.798\ t \cdot 9.81 = 655.29\ kN$$

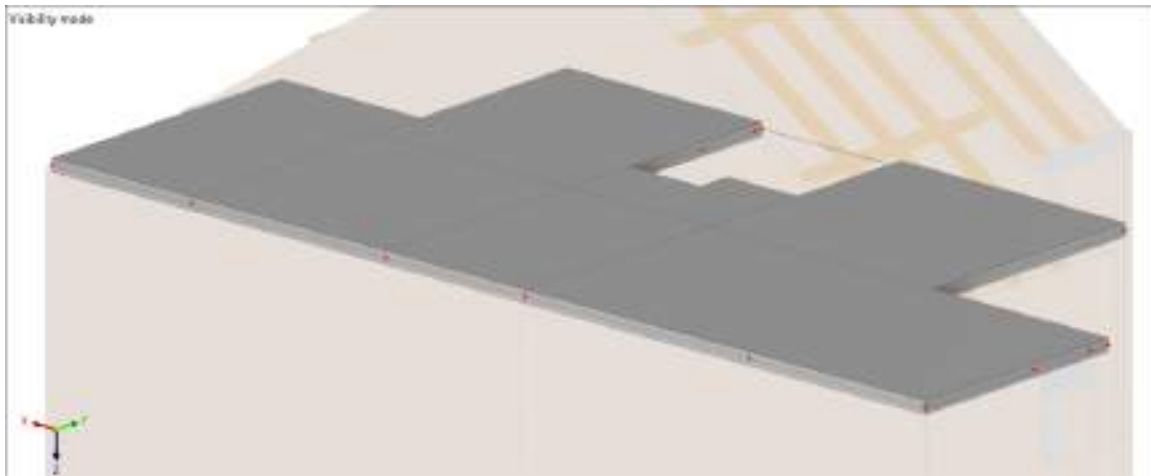

Information About Surfaces			
Area of surfaces	A	77.858	m ²

$$G_{sloj} = 68.198\ m^2 \cdot 3.0\ kN/m^2 = 204.59\ kN$$

$$G_{prvi\ kat} = 655.29 + 204.59 = 859.88\ kN$$

Potkrovlje

$$G_{\text{potkrovlje}} = G_{\text{zid}} + G_{\text{krov}} + G_{\text{sloj}}$$

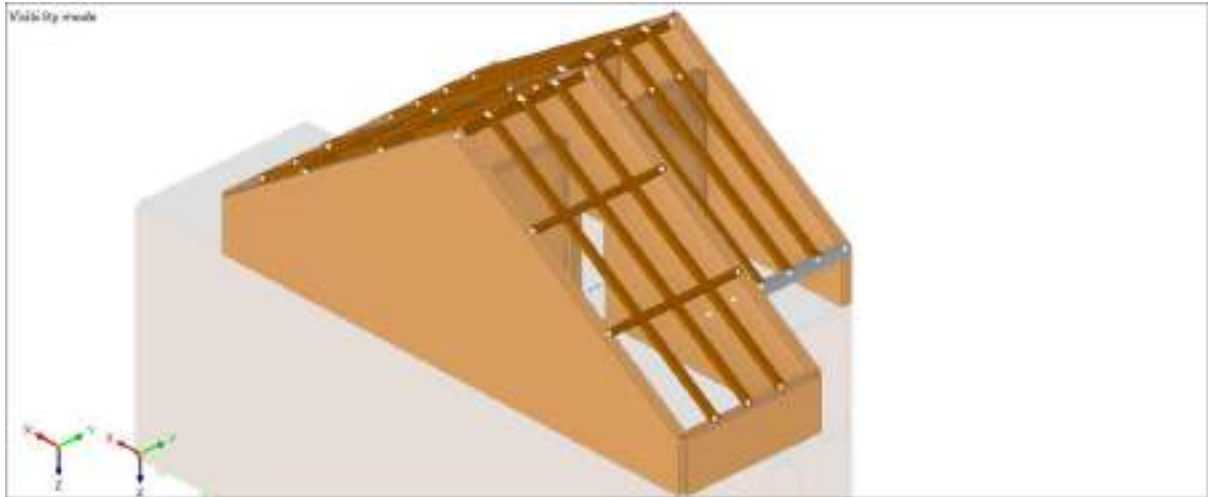

Information About All Selected Objects

Area of surfaces	A	141.818	m ²
Length of members	L	112.540	m
Surface of coating	S	381.981	m ²
Volume	V	38.073	m ³
Mass	M	29.760	t

$$G_{\text{zid}} + G_{\text{krov}} = 29.760 \text{ t} \rightarrow 29.760 \text{ t} \cdot 9.81 = 291.95 \text{ kN}$$

$$G_{\text{sloj}} = 87.435 \text{ m}^2 \cdot 2.4 \text{ kN/m}^2 = 209.84 \text{ kN}$$

$$G_{\text{potkrovlje}} = 291.95 + 209.84 = 501.79 \text{ kN}$$

Uporabno opterećenje:

$$Q_{\text{prizemlje}} = 67.508 \cdot 2.5 + 6.163 \cdot 2.5 + 9.66 \cdot 4 = 222.82 \text{ kN}$$

$$Q_{1. \text{ kat}} = 68.198 \cdot 2.5 + 6.136 \cdot 2.5 = 185.84 \text{ kN}$$

Ukupno stalno opterećenje:

$$\Sigma G = G_{\text{prizemlje}} + G_{1. \text{ kat}} + G_{\text{potkrovlje}}$$

$$\Sigma G = 933.20 + 859.88 + 501.79 = 2294.87 \text{ kN}$$

Ukupno promjenjivo opterećenje množeno s faktorom 0.3:

$$\Sigma Q = Q_{\text{prizemlje}} + Q_{1. \text{ kat}}$$

$$\Sigma Q = 0.3 \cdot (222.82 + 185.84) = 122.60 \text{ kN}$$

$$W = \Sigma(G + Q) = 2417.47 \text{ kN}$$

$$W_1 = G_{\text{prizemlje}} + 0.3 \cdot Q_{\text{prizemlje}} = 933.20 + 0.3 \cdot 222.82 = 1000.05 \text{ kN}$$

$$W_2 = G_{\text{prvi kat}} + G_{\text{potkrovlje}} + 0.3 \cdot Q_{\text{prvi kat}} = 859.88 + 501.79 + 0.3 \cdot 185.84 = 1417.42 \text{ kN}$$

$$F_{bd} = S_d(T_1) \cdot \frac{W}{g} \cdot \lambda$$

$$F_{bd} = 2,86 \cdot \frac{2417.47}{9.81} \cdot 1 = 704.79 \text{ kN}$$

Seizmičke sile po etažama:

$$F_{bd} = \gamma_1 \cdot F_{bd} \cdot \frac{h_i \cdot W_i}{\Sigma h_i \cdot W_i}$$

$$F_{bd,1} = 1 \cdot 704.79 \cdot \frac{2.65 \cdot 1000.05}{2.65 \cdot 1000.05 + 5.389 \cdot 1417.42} = 181.54 \text{ kN}$$

$$F_{bd,2} = 1 \cdot 704.79 \cdot \frac{5.389 \cdot 1417.42}{2.65 \cdot 1000.05 + 5.389 \cdot 1417.42} = 523.25 \text{ kN}$$

Uočavamo da je ukupna sila od vjetra u smjeru Y znatno manja od ukupne proračunske potresne sile u smjeru Y.

4. KOMBINACIJE OPTEREĆENJA

Lista opterećenja na konstrukciju koja su prikazana u prethodnom proračunu:

■ ■ ■	G	LC1	Vlastita težina
■ ■ ■	Q1 A	LC2	Korisno opterećenje
■ ■ ■	Qs	LC5	Snijeg
■ ■ ■	AE	LC6	Potres X
■ ■ ■	AE	LC7	Potres Y

Lista kombinacija opterećenja:

■ ■ ■	ULS	CO1	$1.35 \cdot LC1 + 1.50 \cdot LC2 + 1.50 \cdot LC5$
■ ■ ■	ULS	CO2	$LC1 + 0.60 \cdot LC2 + LC6 + 0.30 \cdot LC7$
■ ■ ■	ULS	CO3	$LC1 + 0.60 \cdot LC2 + 0.30 \cdot LC6 + LC7$
■ ■ ■	S Ch	CO4	$LC1 + LC2 + LC5$

- 1.) $1.35 \cdot Vl. \text{ težina} + 1.50 \cdot \text{Korisno opt.} + 1.50 \cdot \text{Snijeg}$
- 2.) $1.00 \cdot \text{Stalno} + 0.60 \cdot \text{Korisno opt.} + \text{Potres X} + 0.30 \cdot \text{Potres Y}$
- 3.) $1.00 \cdot \text{Stalno} + 0.60 \cdot \text{Korisno opt.} + 0.30 \cdot \text{Potres X} + \text{Potres Y}$
- 4.) $1.00 \cdot Vl. \text{ težina} + 1.00 \cdot \text{Korisno opt.} + 1.00 \cdot \text{Snijeg}$

5. DIMENZIONIRANJE

5.1. Unutarnje sile ploče

Moment u smjeru X

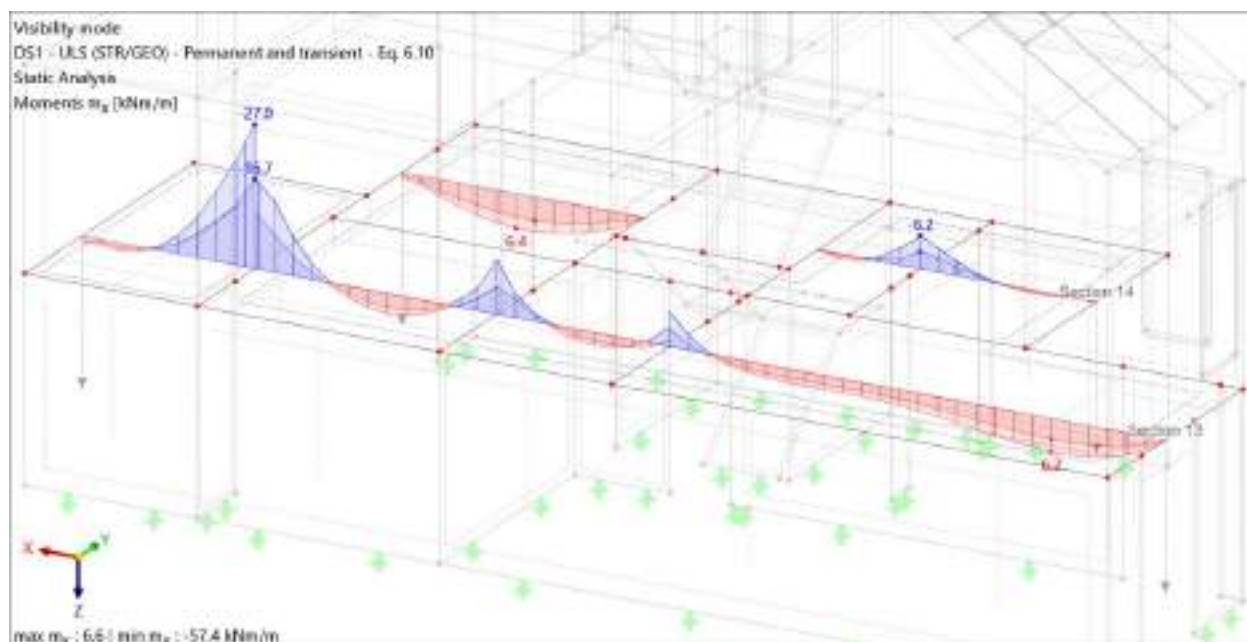

Moment u smjeru Y

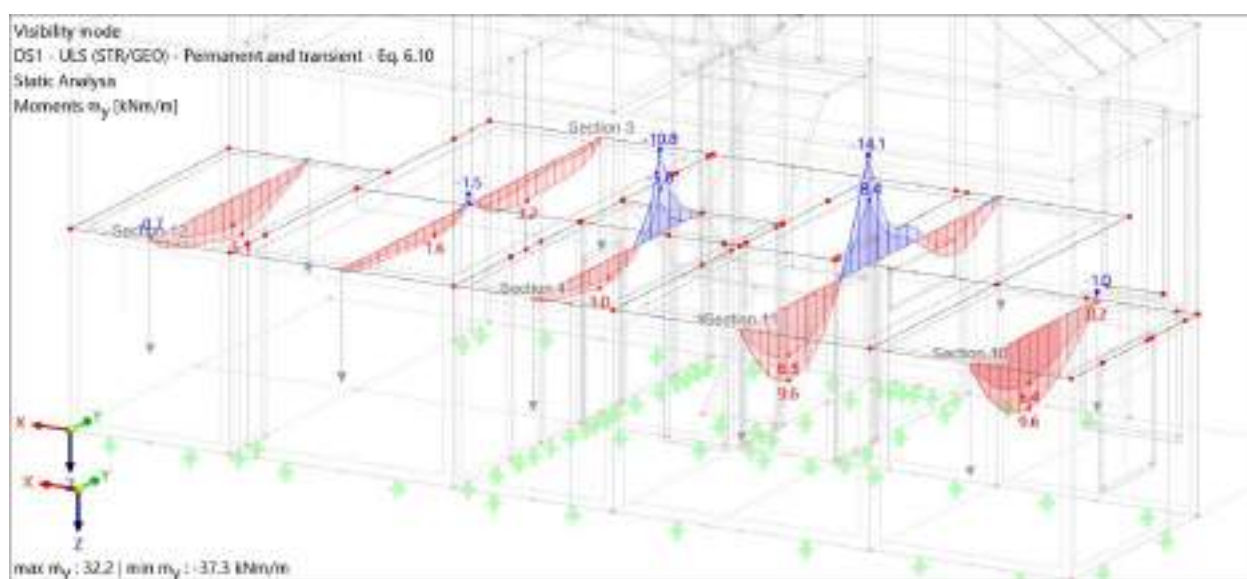

Poprečna sila

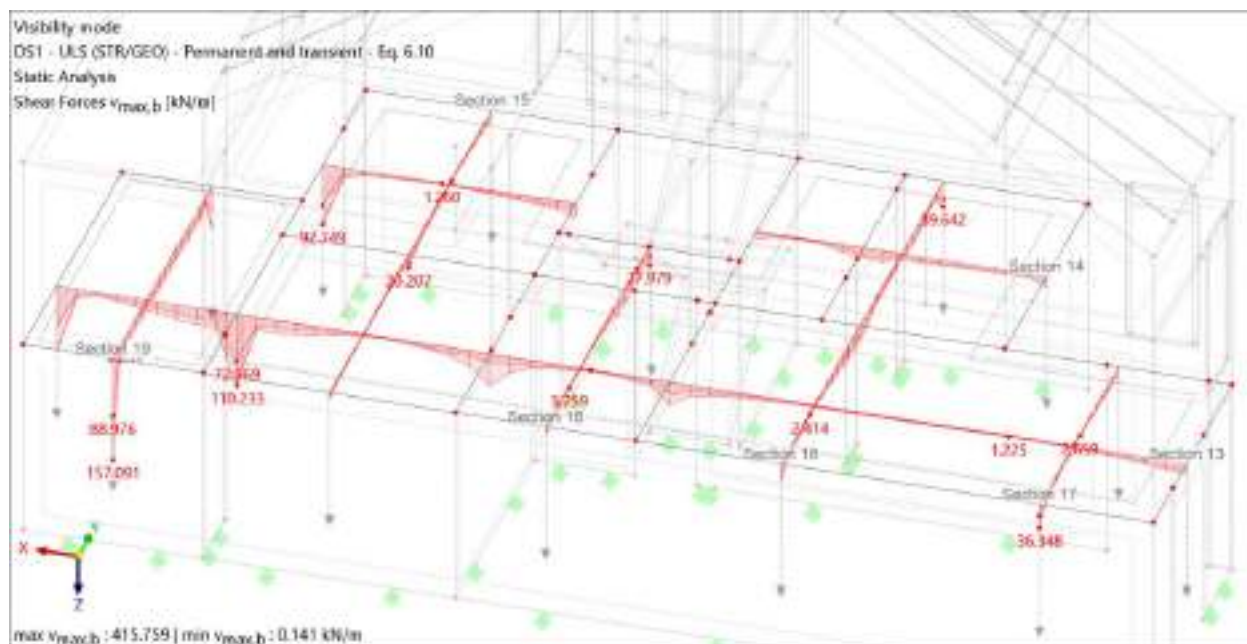

5.2. Potrebna armatura ploče

Potrebna armatura ploče – gornja zona, smjer X

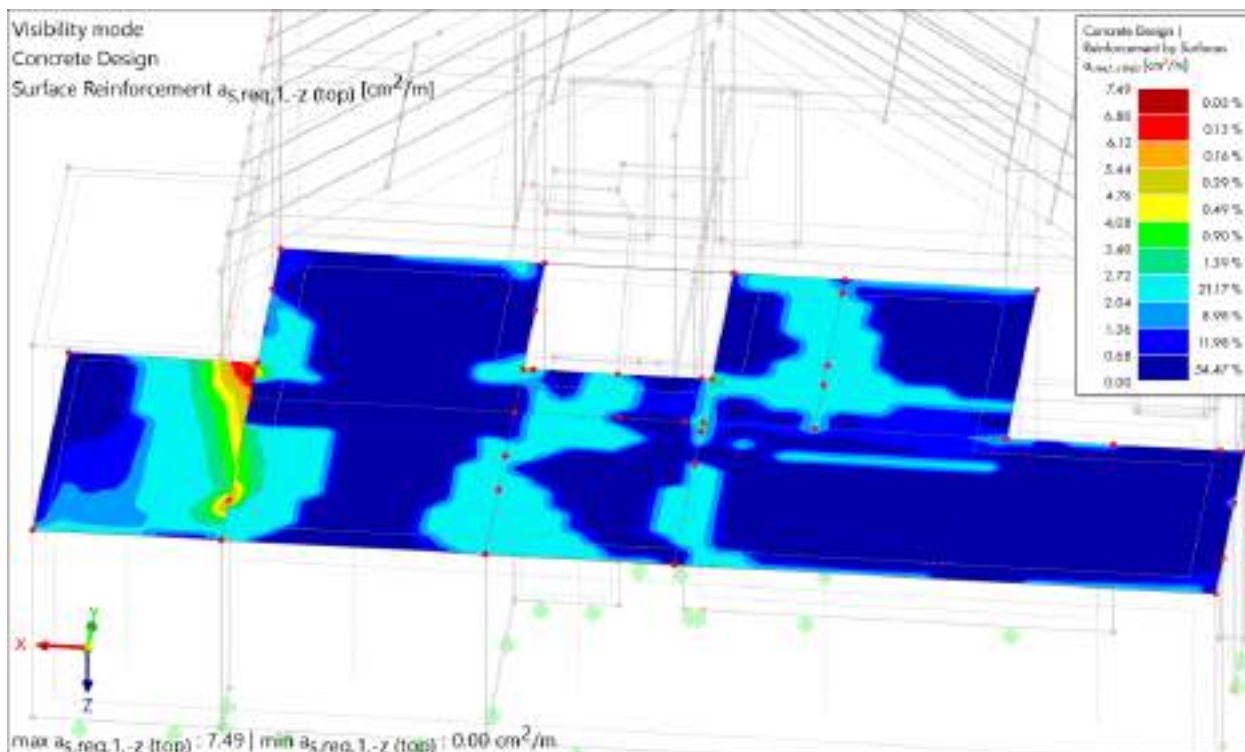

Potrebna armatura ploče – gornja zona, smjer Y

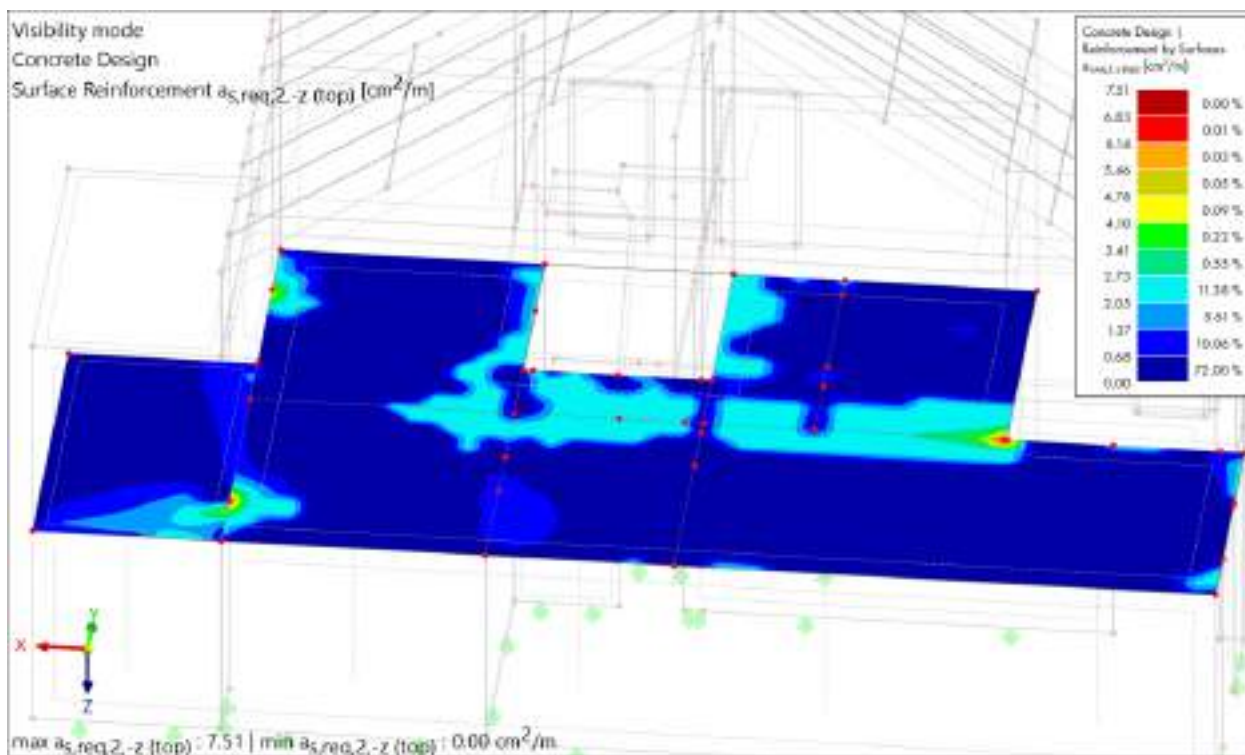

Potrebna armatura ploče – donja zona, smjer X

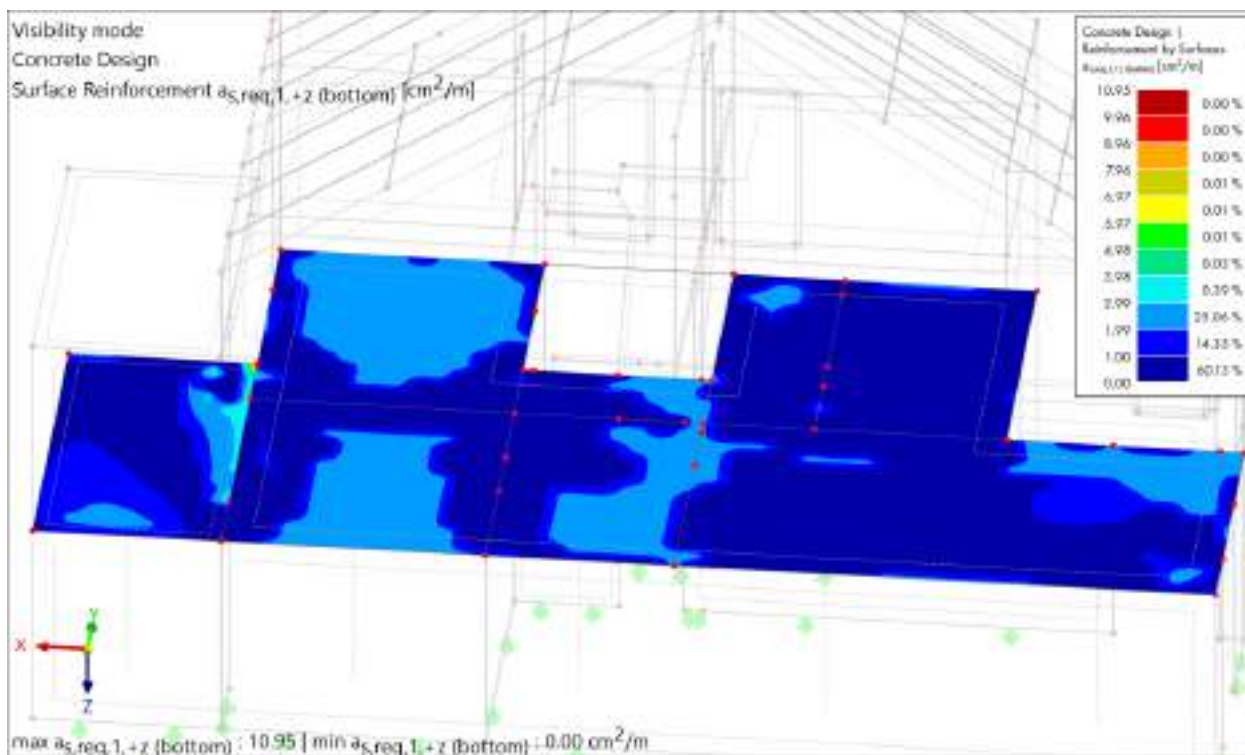

Potrebna armatura ploče – donja zona, smjer Y

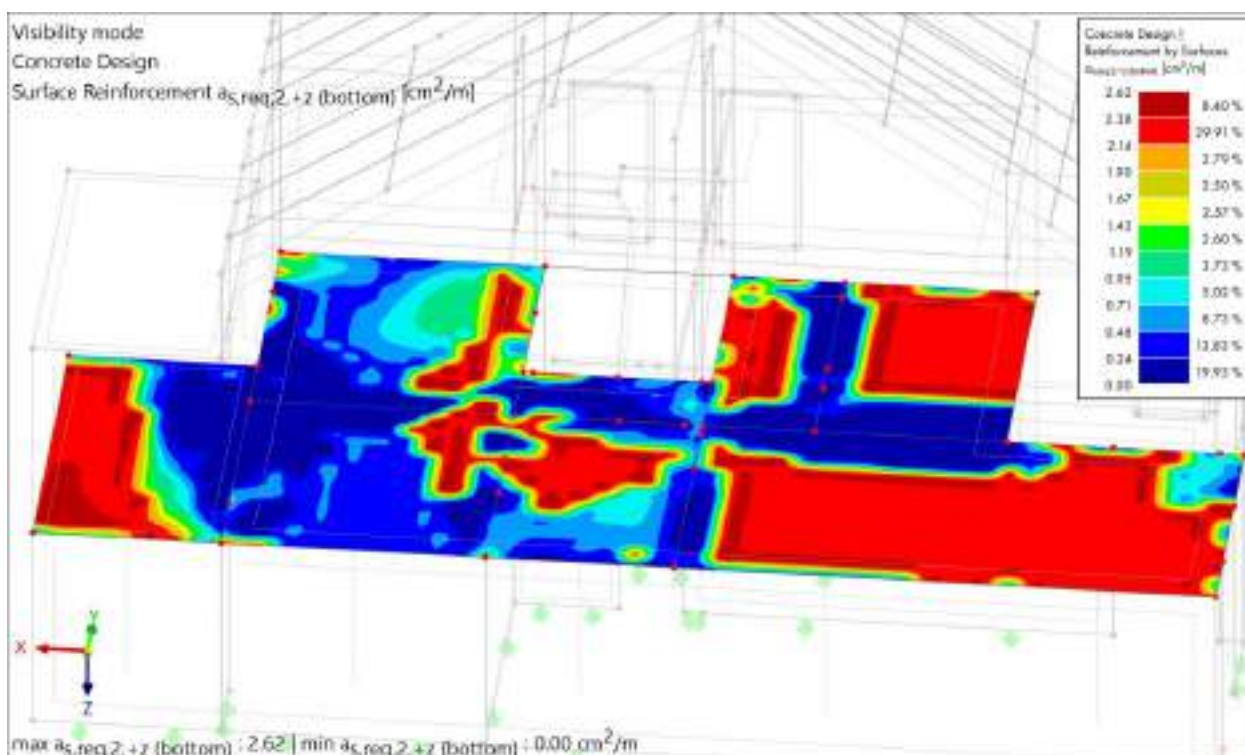

5.3. Potrebna armatura greda

Potrebna armatura greda – gornja zona

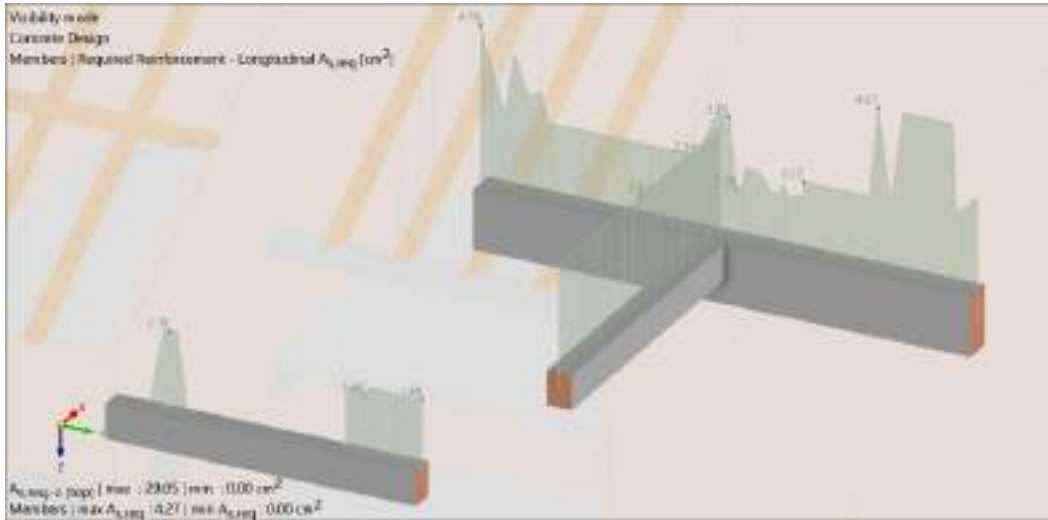

Potrebna armatura greda donja zona

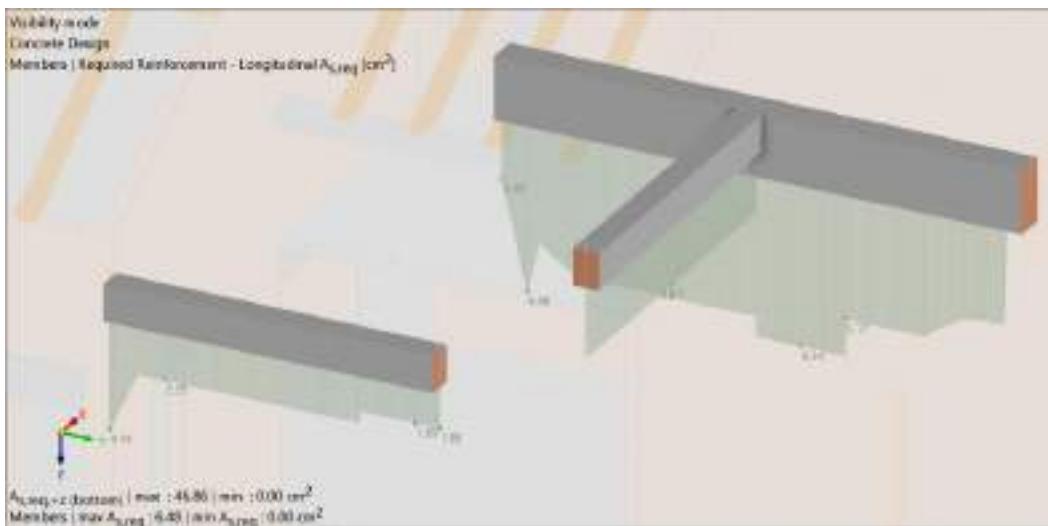

Vilice



5.4. Prikaz zidova i pripadnih unutarnjih sila

Zidovi smjera X

Zid 1

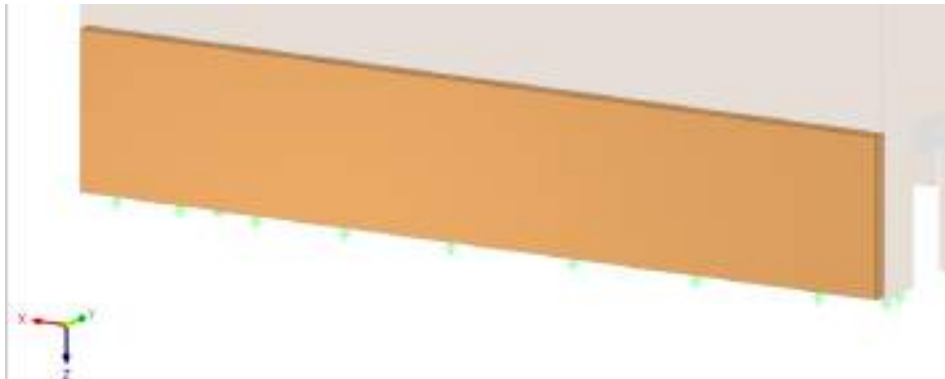
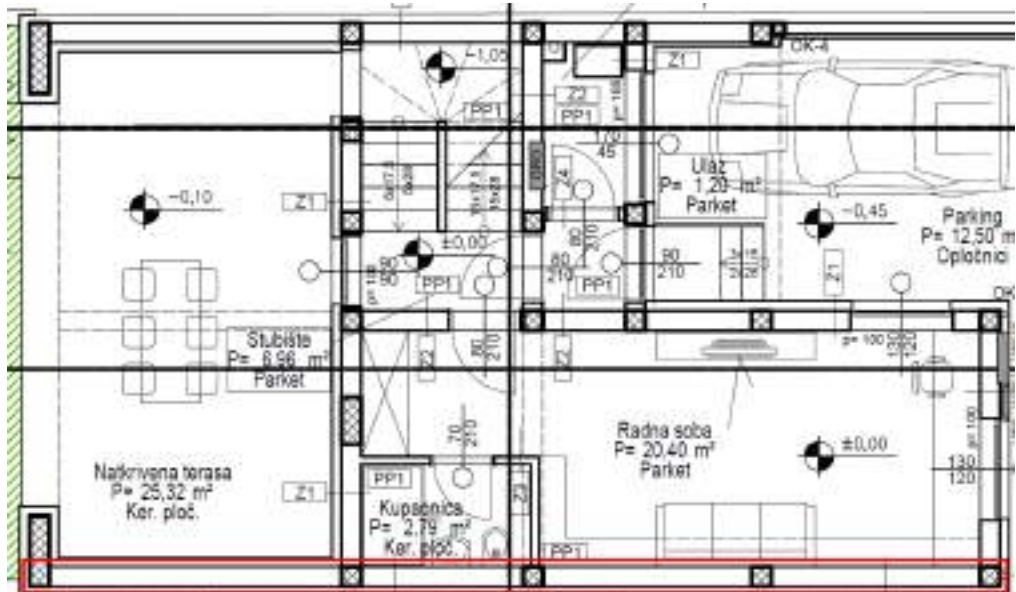

Poprečna sila

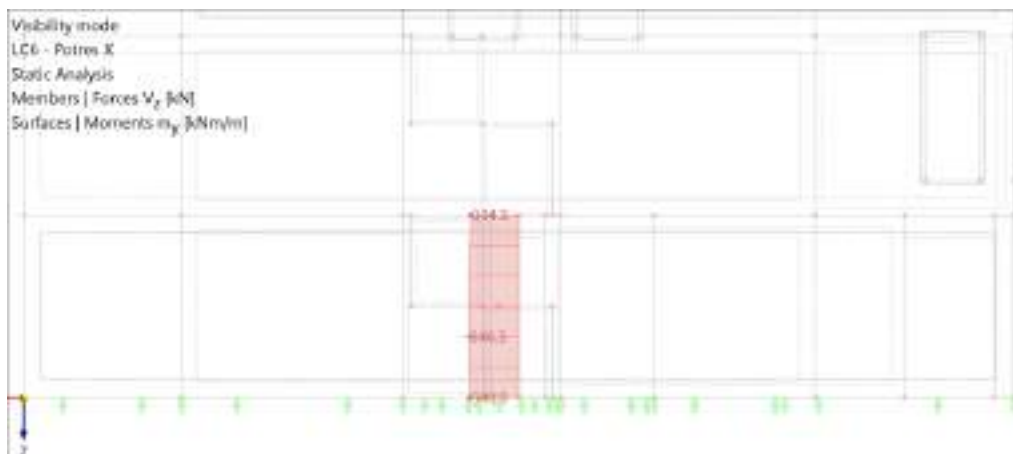

Zid 2

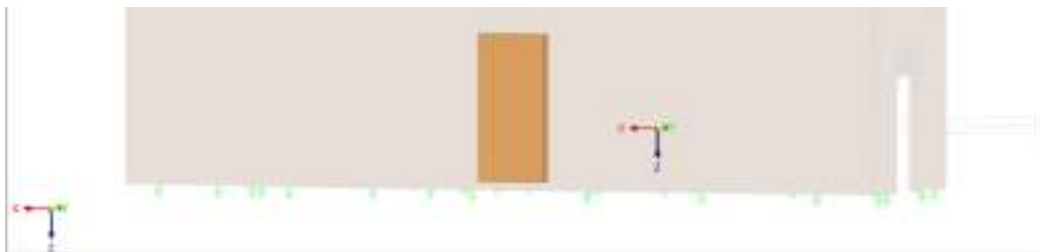
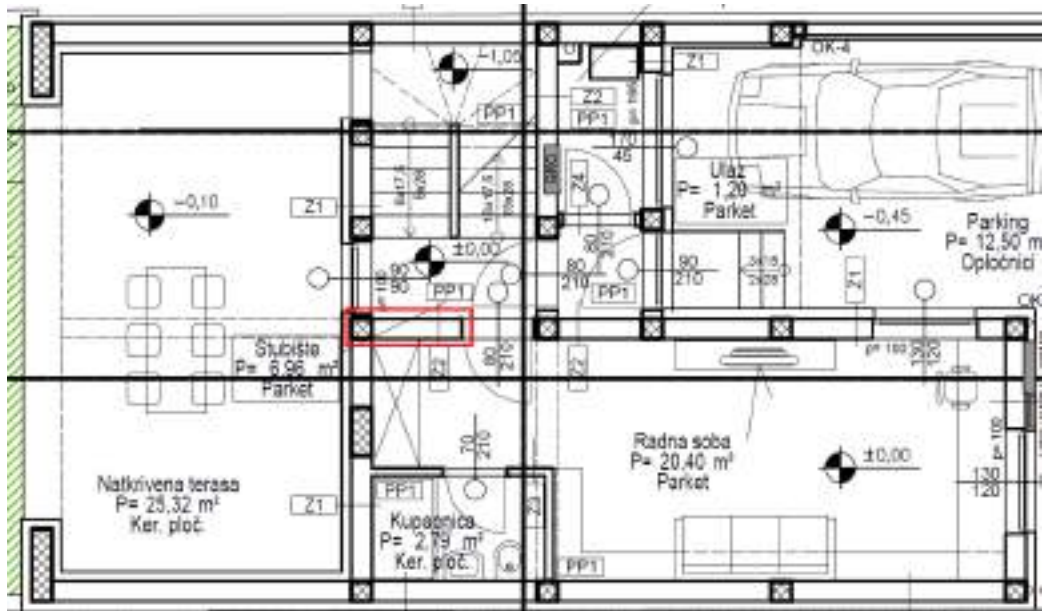

Poprečna sila

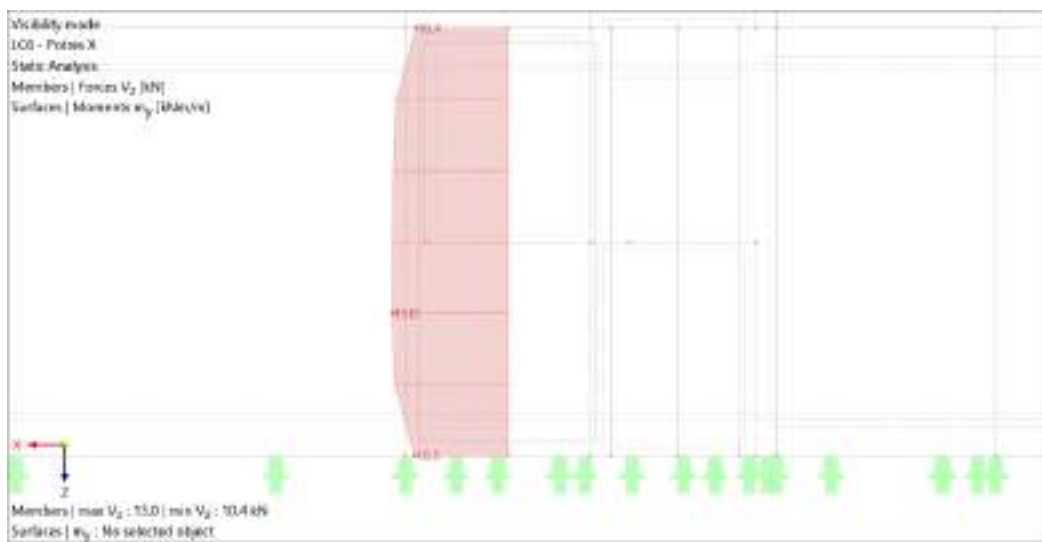

Zid 3

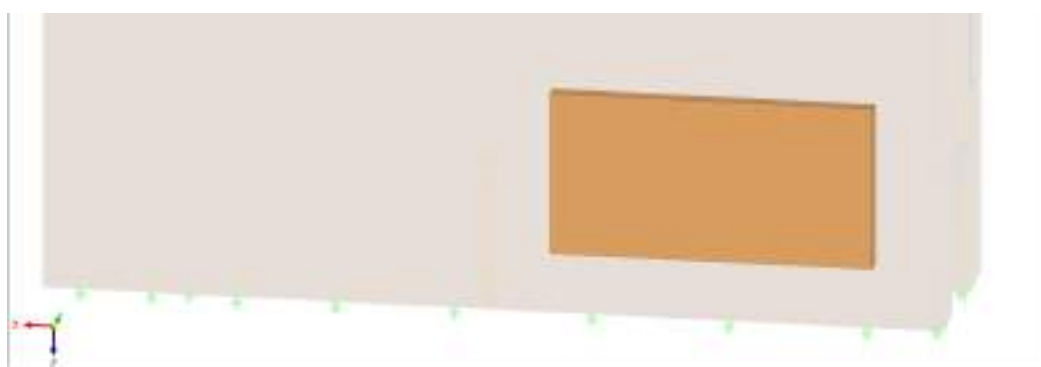
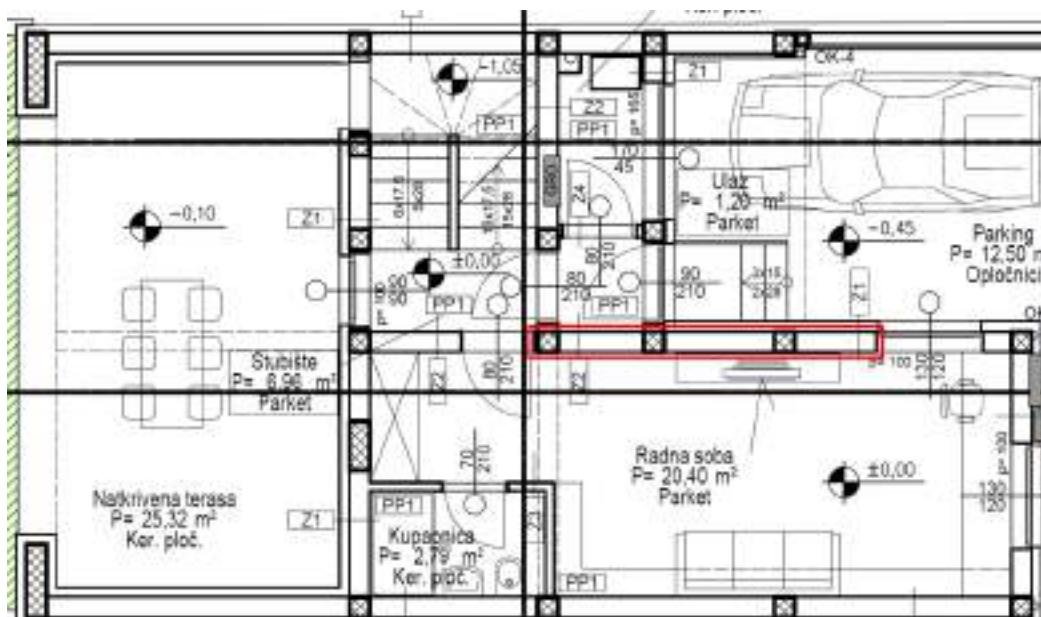

Poprečna sila

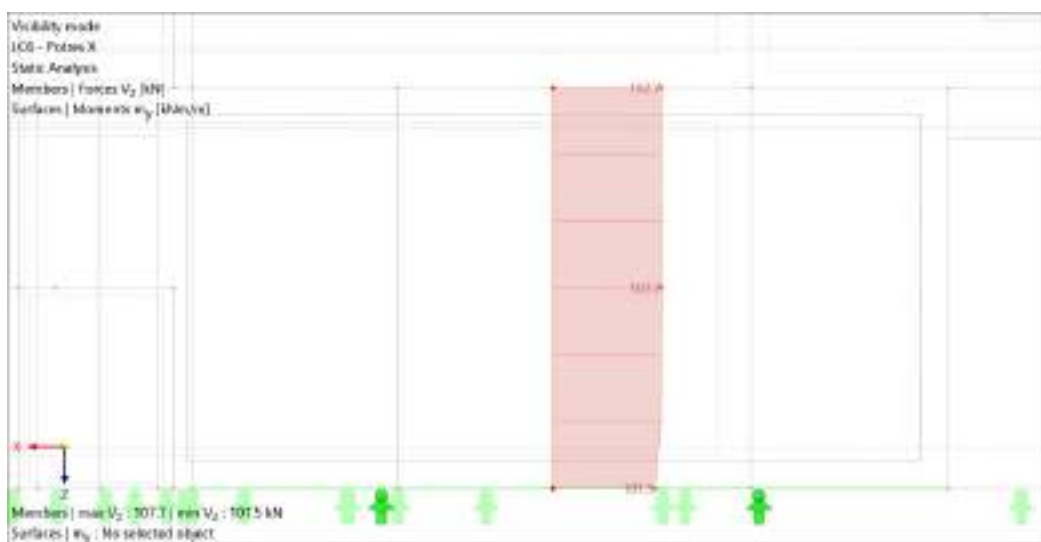

Zid 4

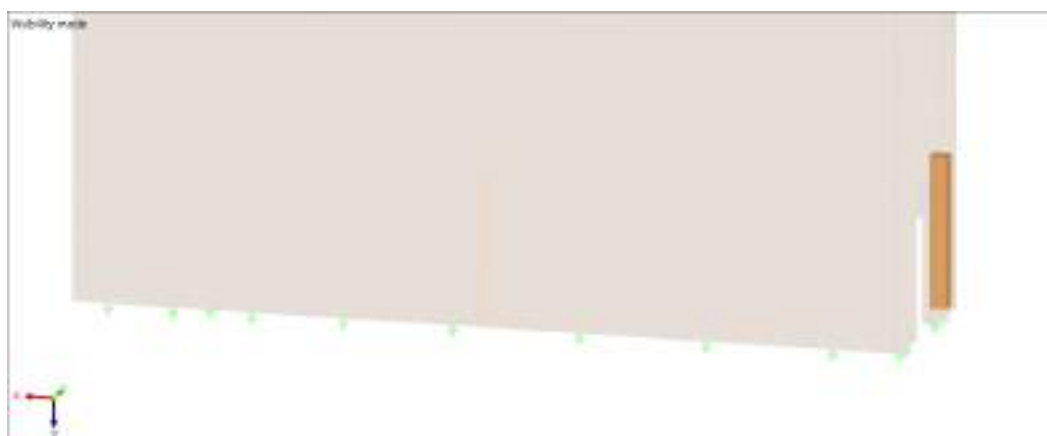
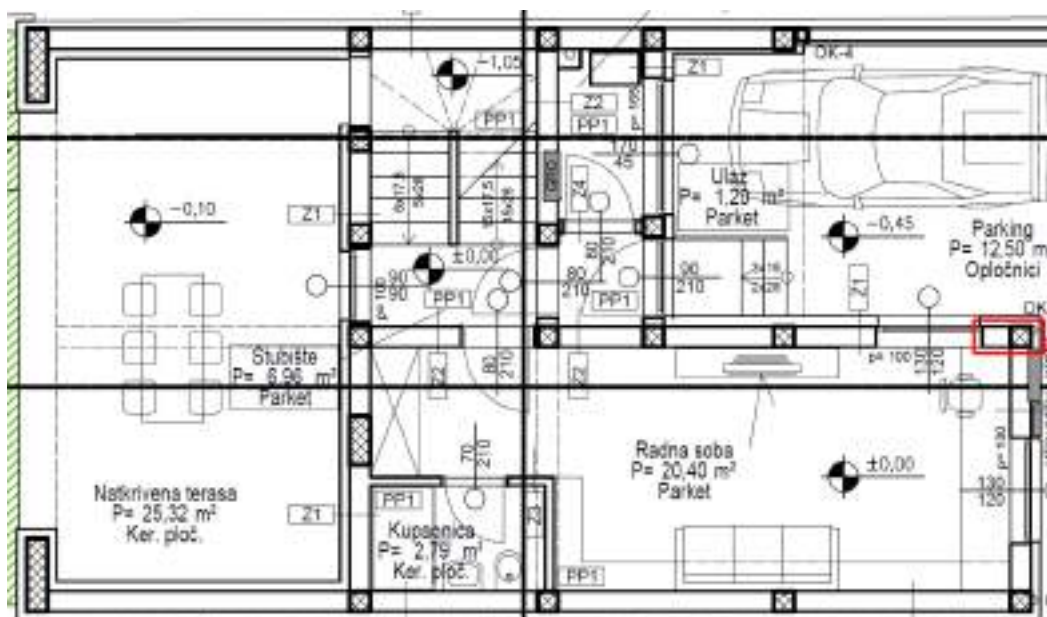

Poprečna sila

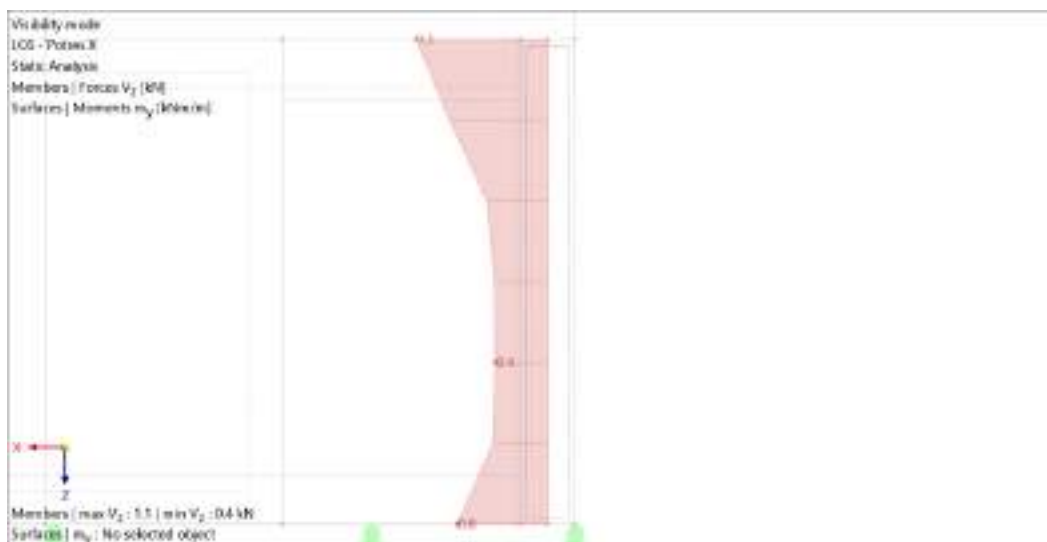

Zid 5

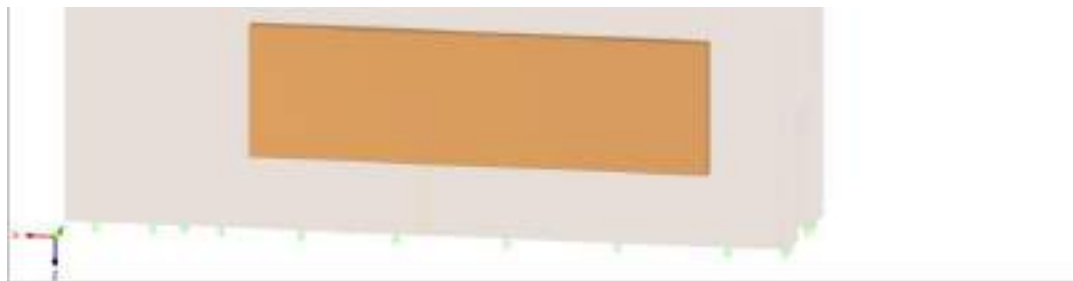
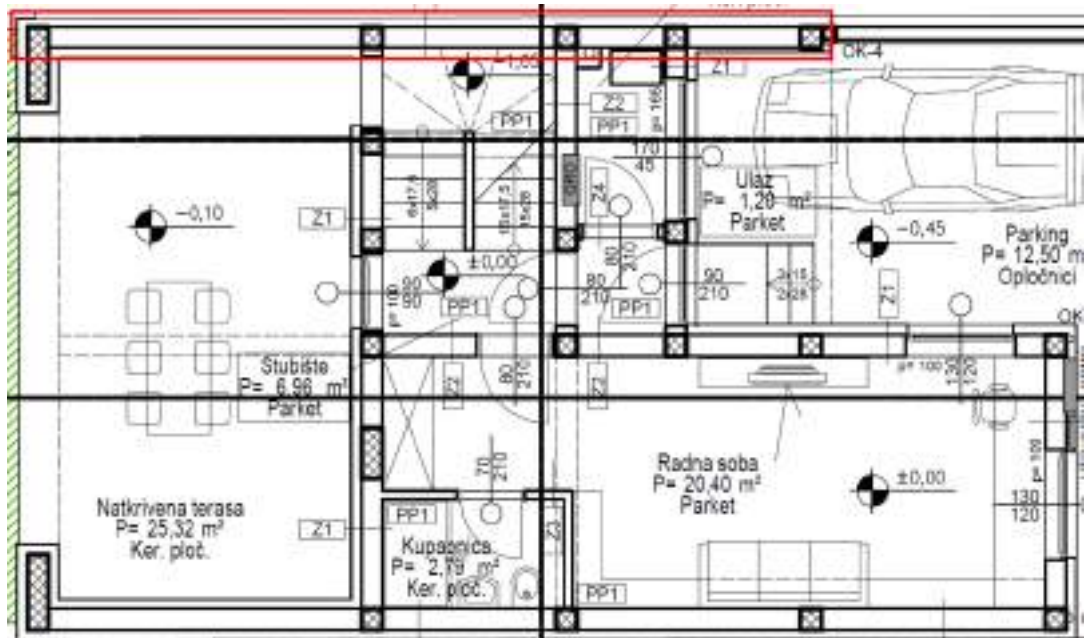

Poprečna sila

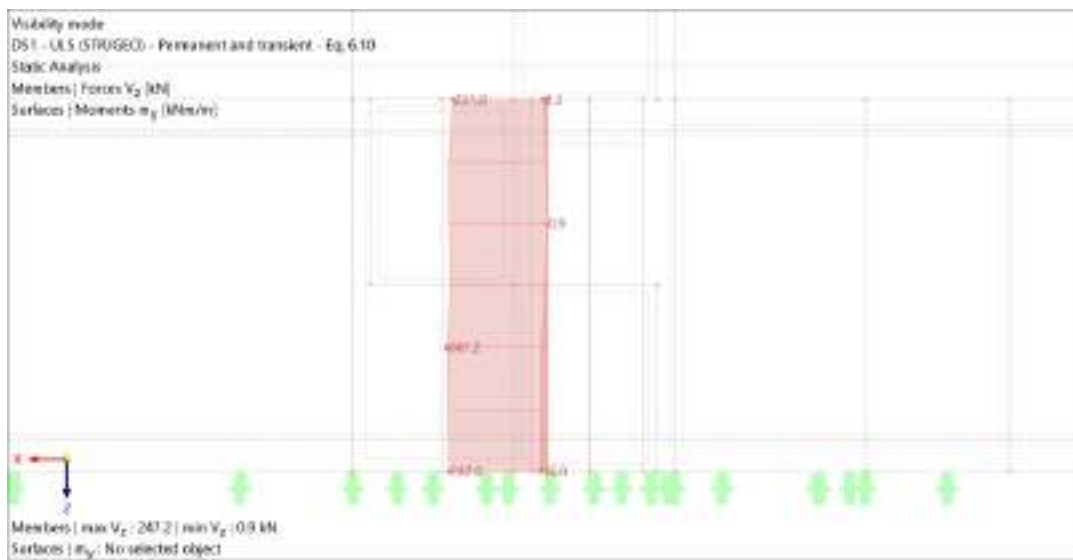

Tablični prikaz - X smjer

ZID	N [kN]	V [kN]	M [kNm]
1	947.1	340.9	1148.7
2	150.8	10.5	11.5
3	522.3	107.7	194.3
4	39.8	1.1	4.2
5	876.3	242.0	489.5
SUMA		702.2	

Dokaz iz programa RFEM 6 za smjer X

Description	Value	Unit	
Sum of loads in X	704.6	kN	
Sum of support forces in X	704.6	kN	Deviation: 0.00 %

Zidovi smjera Y

Zid 1

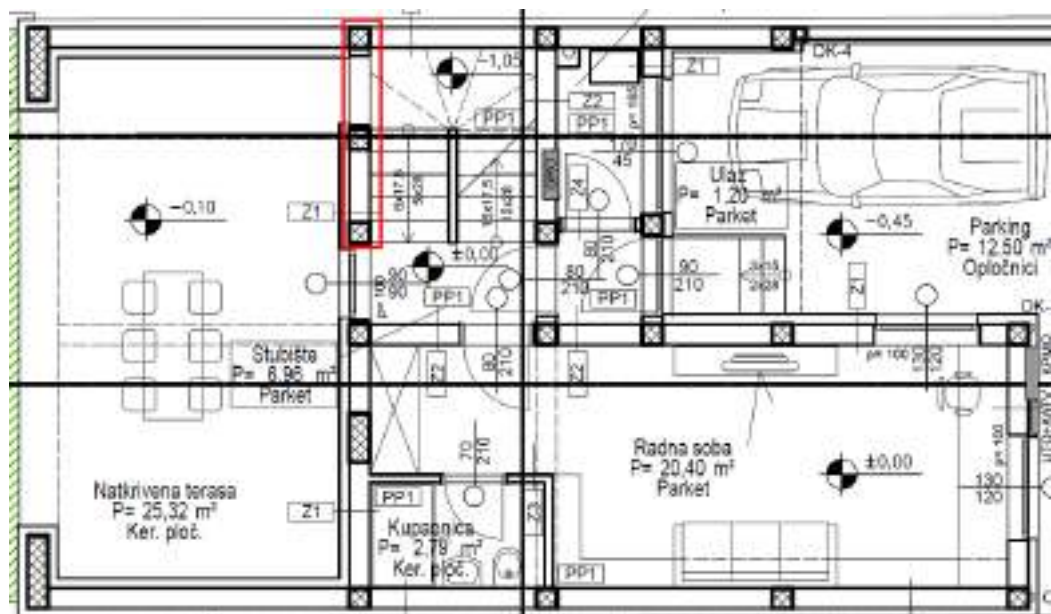

Poprečna sila

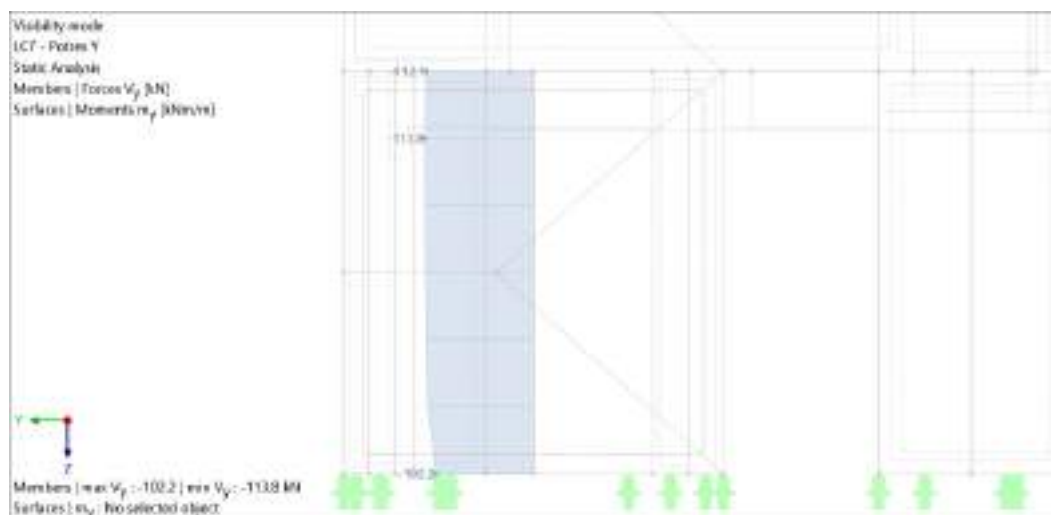

Zid 2

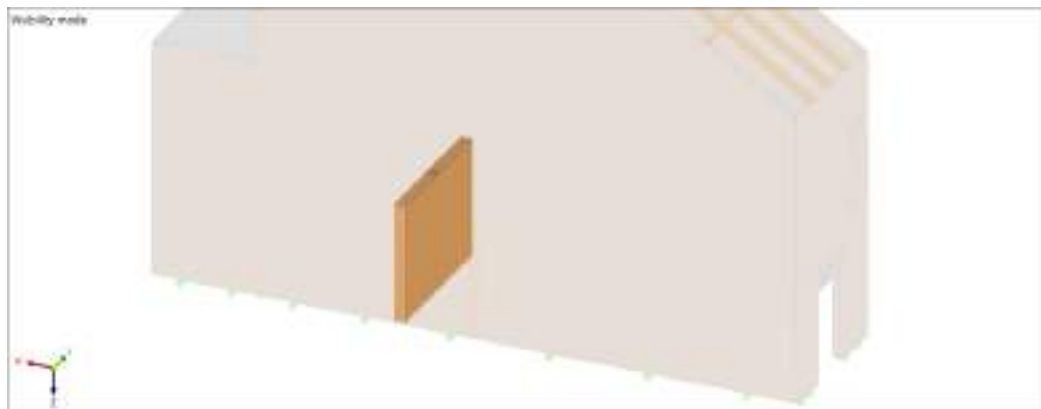
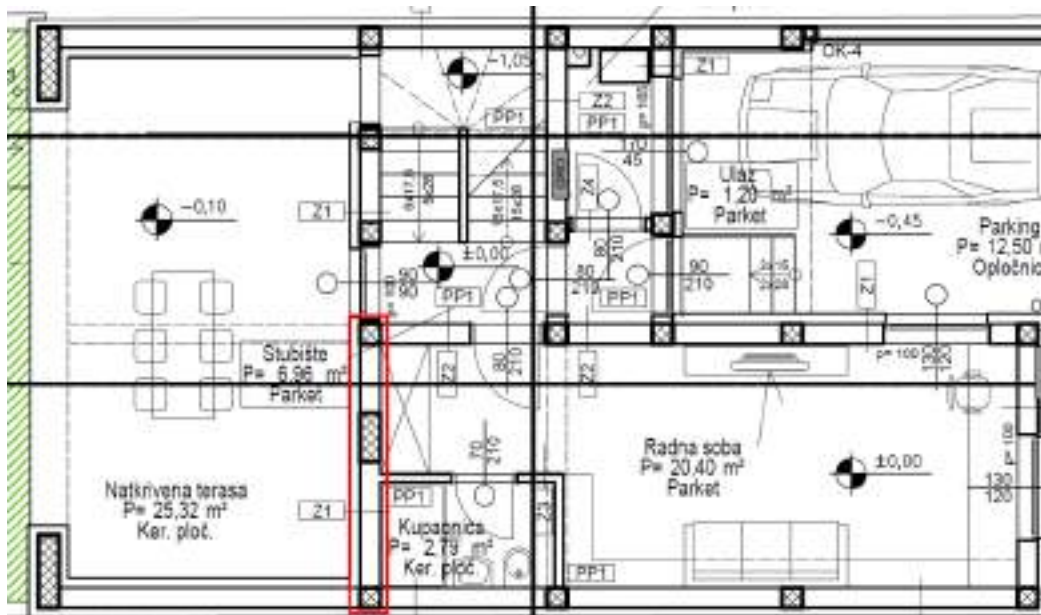

Poprečna sila

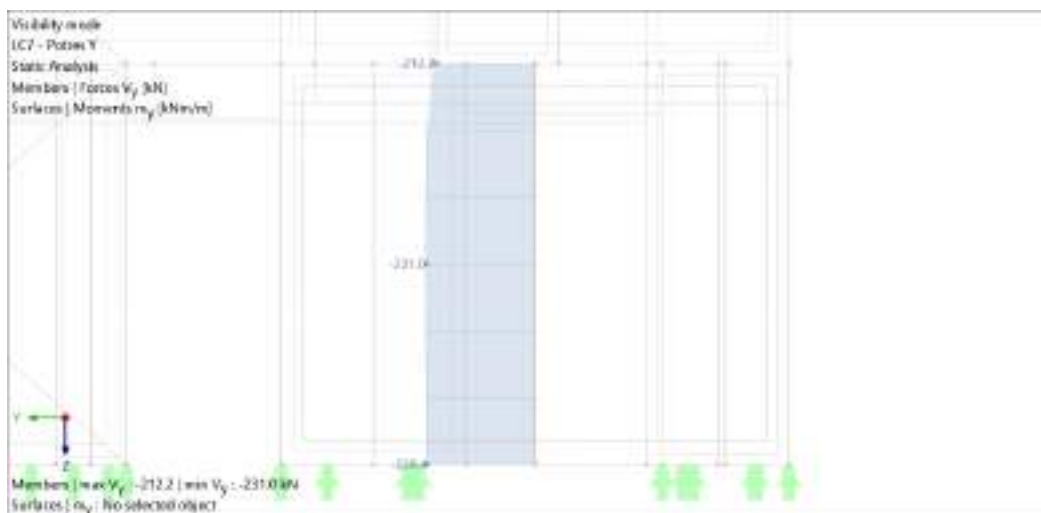

Zid 3

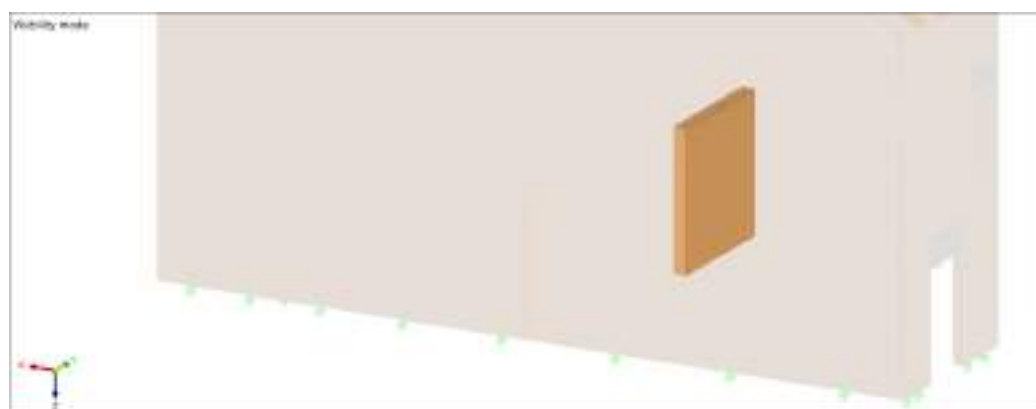
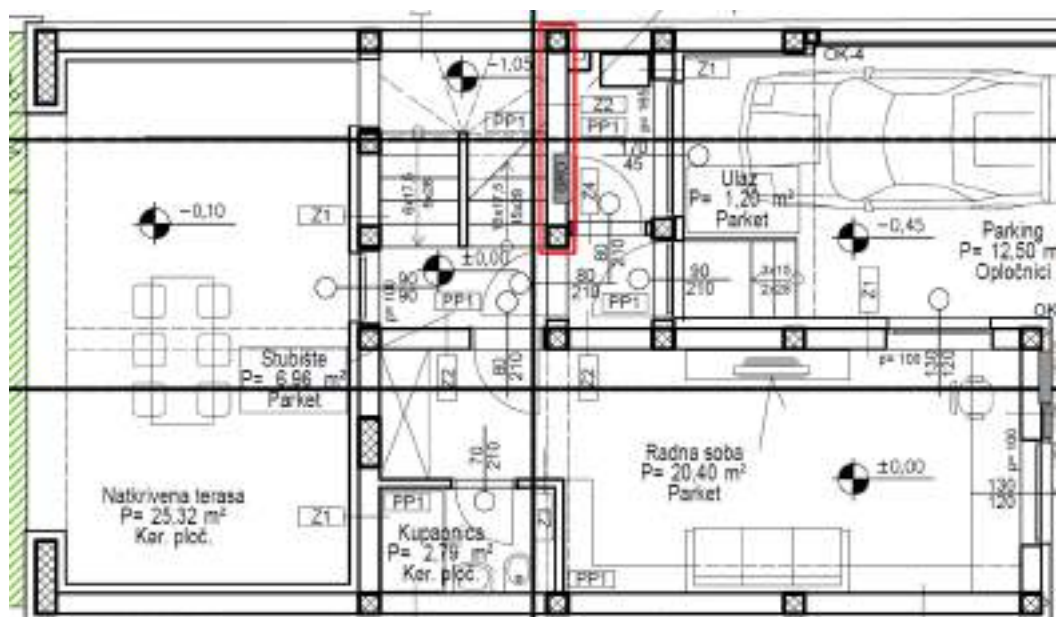

Poprečna sila

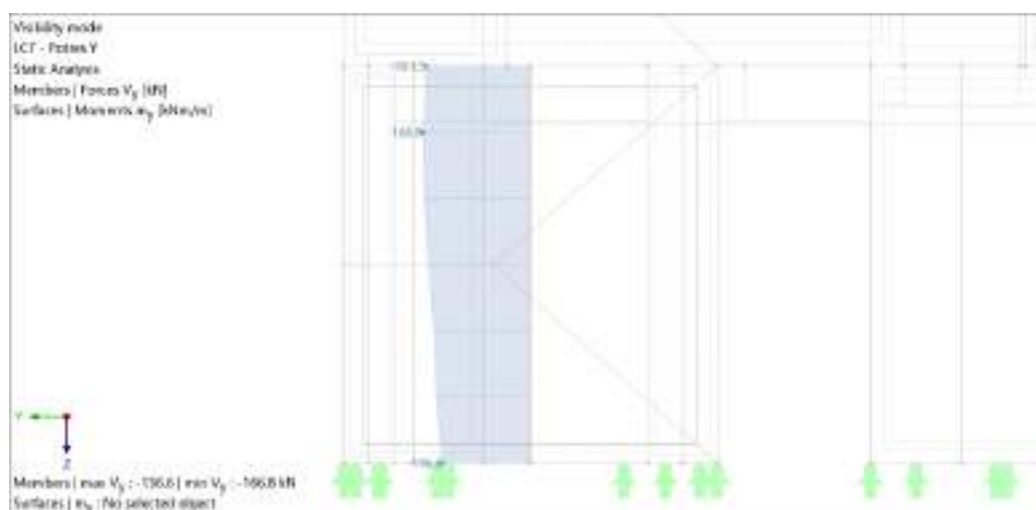

Zid 4

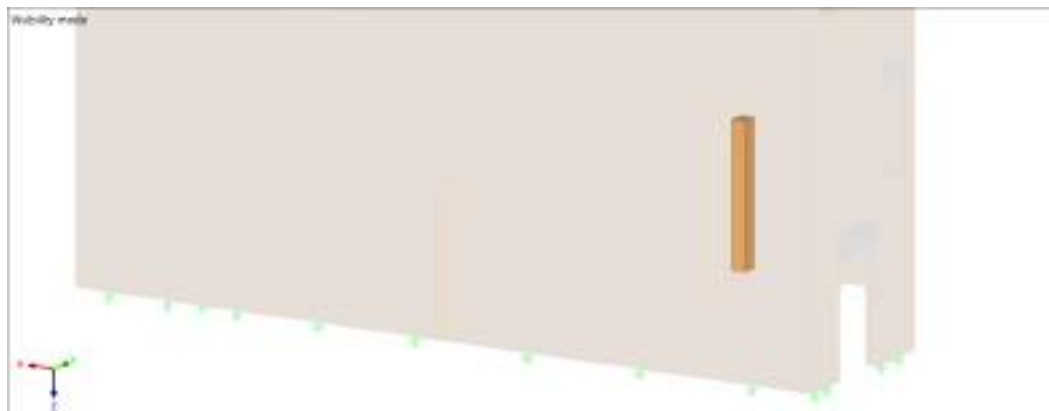
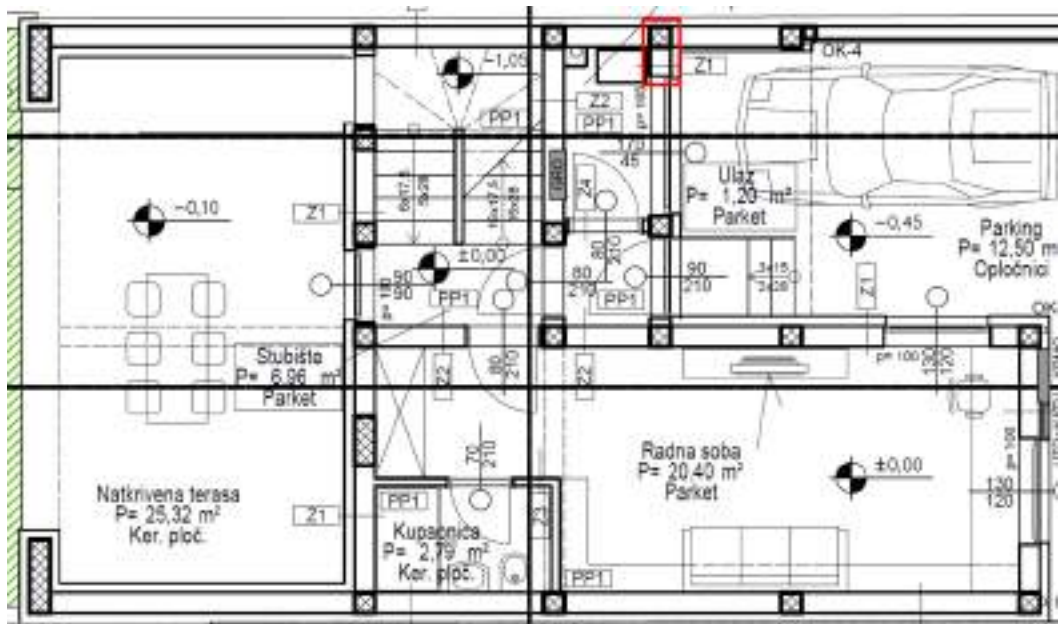

Poprečna sila

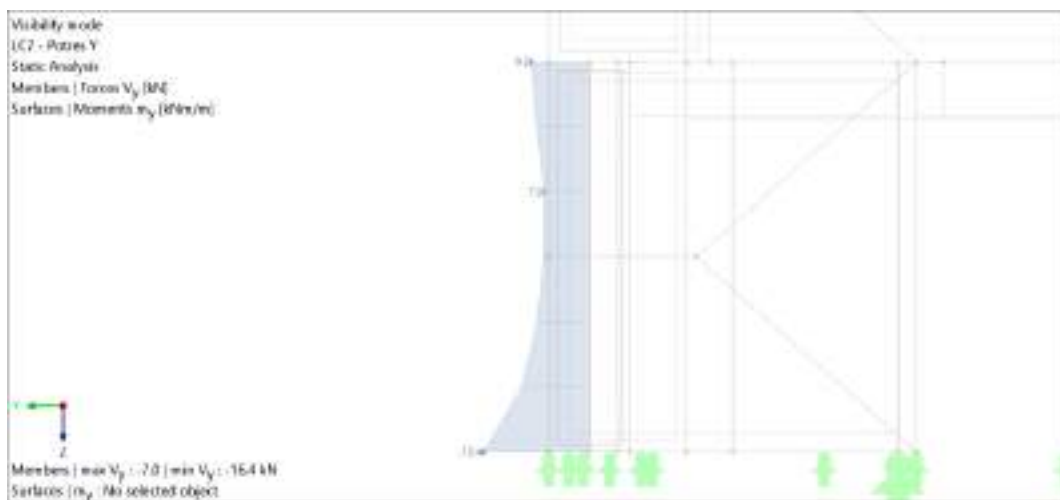

Zid 5

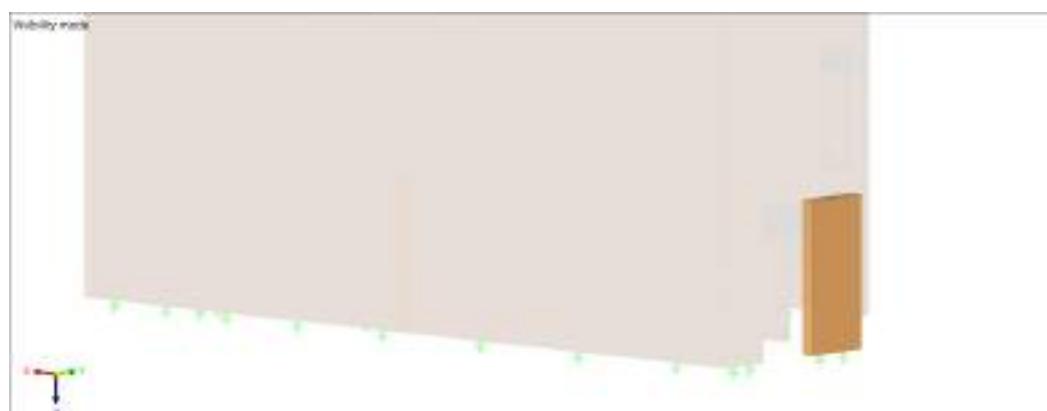
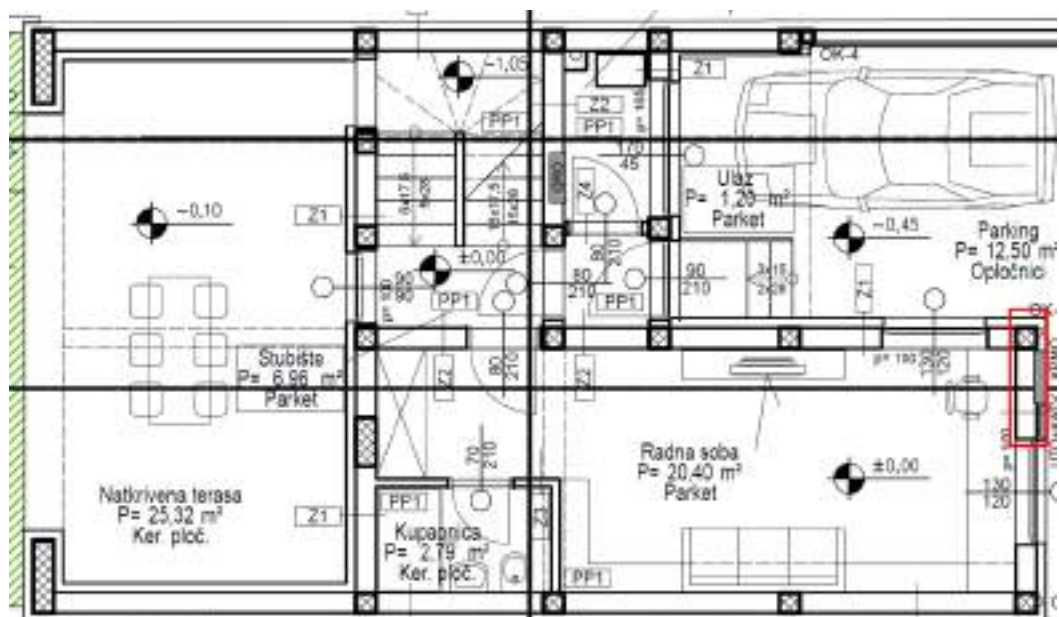

Poprečne sile

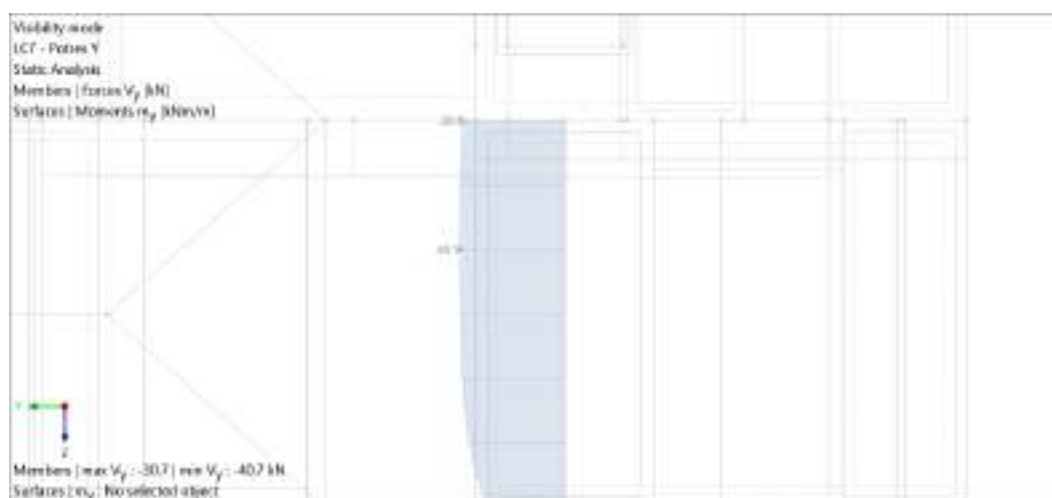

Zid 6

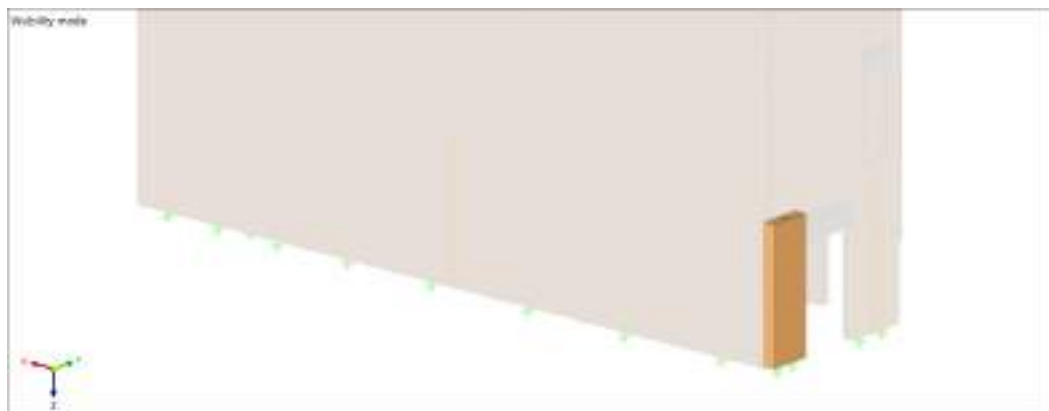
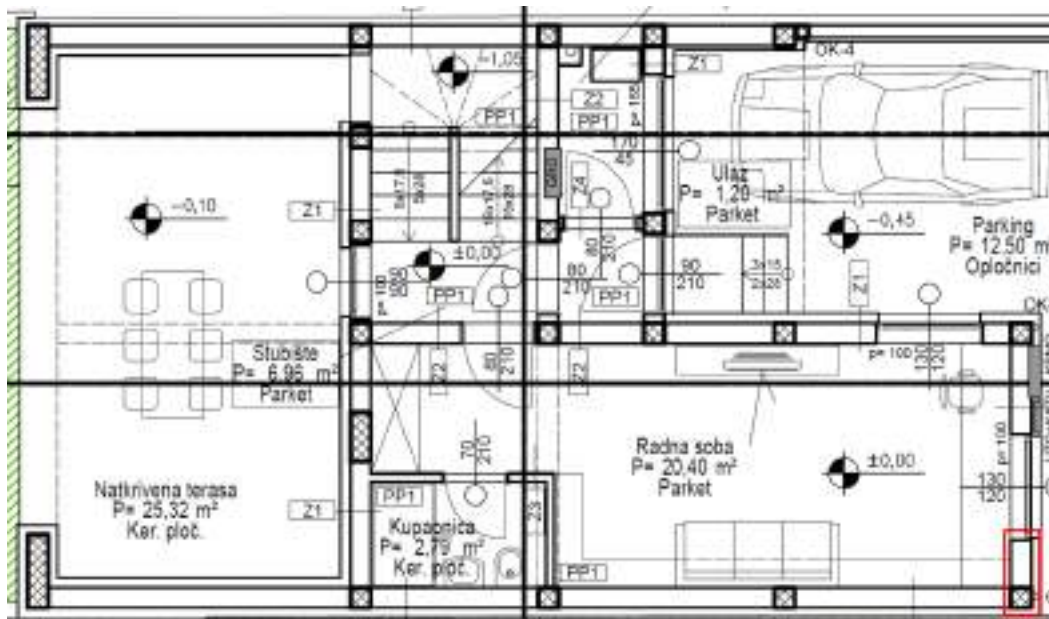

Poprečna sila

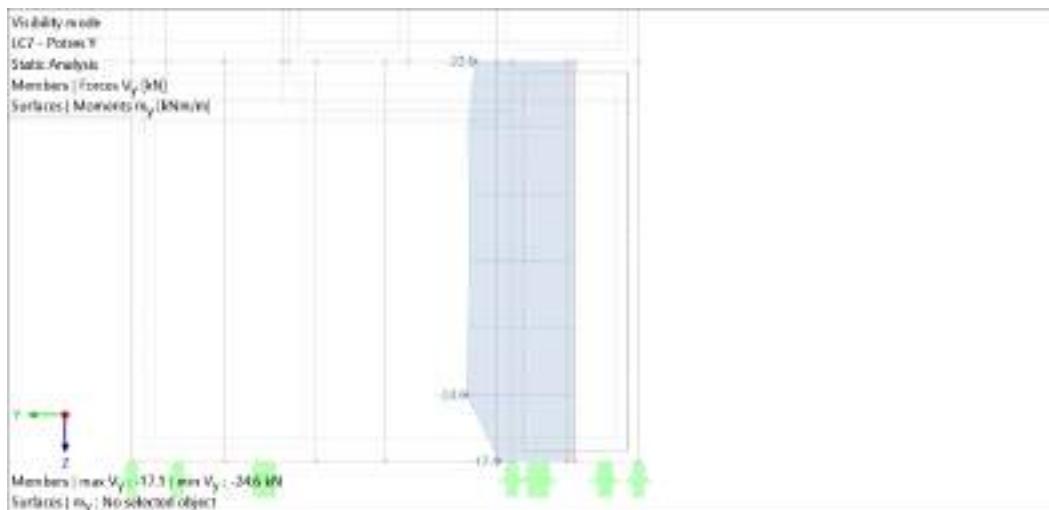

AB elementi

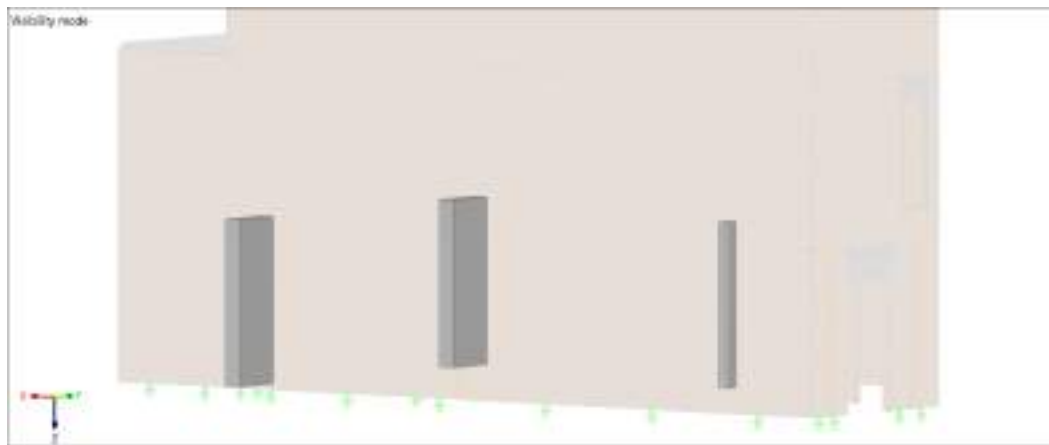
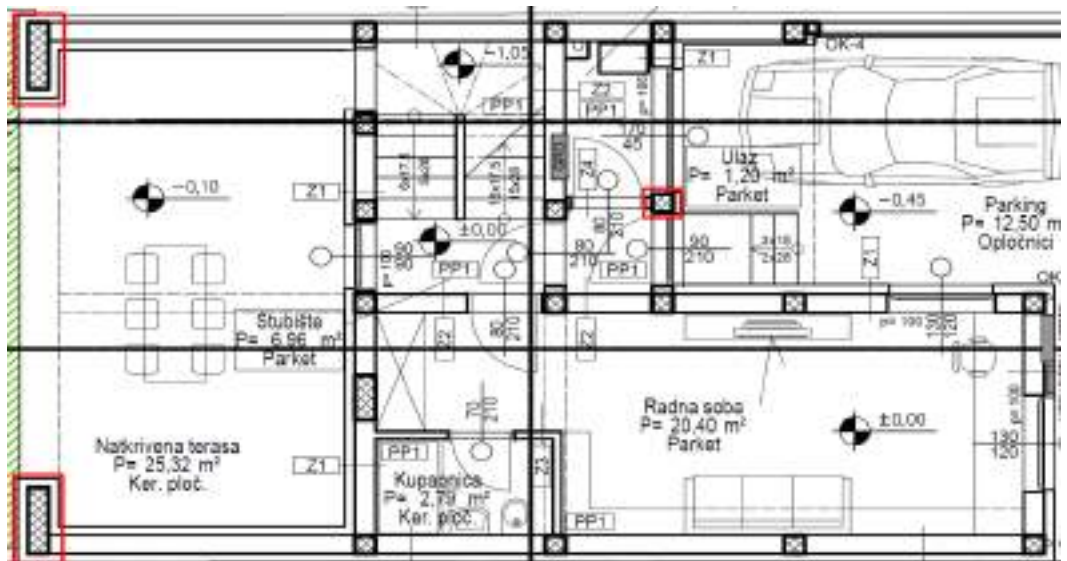

Poprečna sila

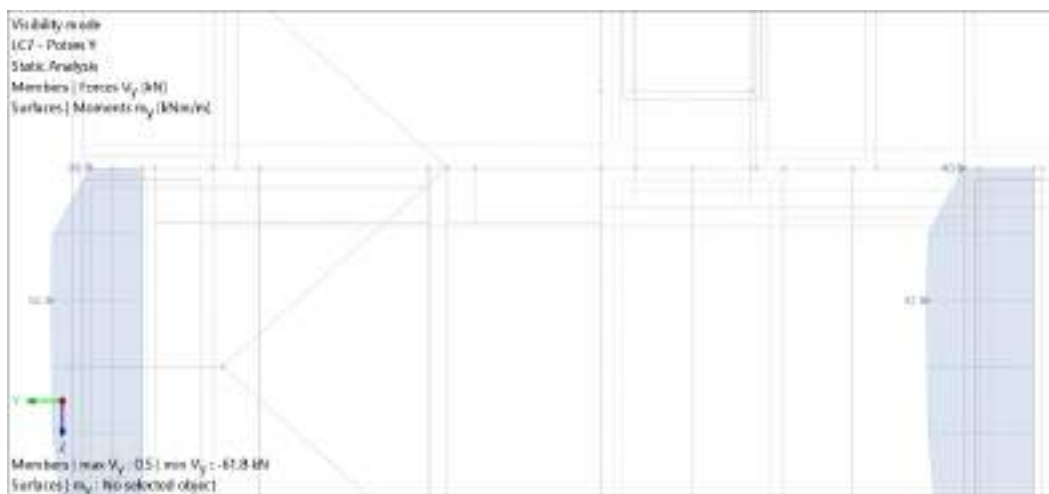

Tablični prikaz – Y smjer

ZID	N [kN]	V [kN]	M [kNm]
1	141.9	113.8	141.7
2	276.4	228.4	188.1
3	229.5	166.8	158.1
4	52.4	16.4	6.0
5	131.4	40.7	54.30
6	68.6	24.6	16.7
AB 1	/	52.3	/
AB 2	/	61.8	/
AB stup	/	/	/
SUMA	/	704.8	/

Dokaz iz programa RFEM 6 za smjer Y

Description	Value	Unit	
Sum of loads in Y	704.6	kN	
Sum of support forces in Y	704.6	kN	Deviation: 0.00 %

5.5. Provjera nosivosti zida

Zid 1 – smjer X

$$N_{Ed} = 947.10 \text{ kN}$$

$$M_{Ed} = 1148.70 \text{ kNm}$$

$$V_{Ed} = 340.90 \text{ kN}$$

$$L = 14.42 \text{ m}$$

$$t_w = 0.25 \text{ m}$$

Karakteriske zida – prema tablici

Zidni element	f	f _m	f _k	G	E	f _i
Puna opeka	10	0.5	2.0	40	250	0.04
Puna opeka	15	2.5	2.5	200	400	0.18
Laki keramički blok	7.5	2.0	5.0	500	4500	0.30
Opečni blok	15	2.5	2.5	300	5000	0.12
Opečni blok	15	5	3.0	300	5000	0.18
Keramzitni blok	7.5	5	3.5	500	5000	0.27
Betonski blok	7.5	5	4.0	600	6000	0.27

Zidni element	Mort	f _{vk0} (N/mm ²)	Granična vrijednost f _{vk} (N/mm ²)
Glineni zidni elementi Grupe 1	M10 do M20,	0.3	1.7
	M2,5 do M9	0.2	1.5
	M1 do M2	0.1	1.2
Zidni elementi Grupe 1 koji nisu glineni, ili nisu od prirodnog kamena	M10 do M20,	0.2	1.7
	M2,5 do M9	0.15	1.5
	M1 do M2	0.1	1.2

Provjera nosivosti zida 1 (smjer X) na posmik:

Tlačna duljina zida za omeđeno zide:

$$L_c = \left(\frac{L}{2}\right) \cdot \left(1 + \frac{L \cdot N_{Ed}}{6 \cdot M_{Ed}}\right) = \left(\frac{14.42}{2}\right) \cdot \left(1 + \frac{14.42 \cdot 947.10}{6 \cdot 1148.70}\right) = 55.35 \text{ m} > 14.42 \text{ m} \rightarrow 14.42 \text{ m}$$

$$A_w = t \cdot L_c = 25 \cdot 1442 = 36050 \text{ cm}^2$$

$$\sigma_d = \frac{N_{Ed}}{A_w} = \frac{947.10}{36050} = 0.0263 \text{ kN/cm}^2 = 0.263 \text{ N/mm}^2$$

$$f_{vk,0} = 0.3 \text{ N/mm}^2 \text{ – prema tablici}$$

$$f_{vk} = f_{vk,0} + 0.4 \cdot \sigma_d = 0.3 + 0.4 \cdot 0.263 = 0.405 \text{ N/mm}^2$$

$$f_{vd} = \frac{f_{vk}}{\gamma_M} = \frac{0.405}{1.5} = 0.270 \text{ N/mm}^2$$

$$V_{Rd} = 0.270 \cdot 250 \cdot 14420 = 973350.00 \text{ N} = 973.35 \text{ kN} > 340.90 \text{ kN} \rightarrow \text{Zadovoljava uvjet!}$$

Provjera nosivosti zida 1 (Smjer X) na vlačni slom

$$L_w = 14.420 \text{ m} > H_w = 2.650 \text{ m} \rightarrow L_w = 2.650 \text{ m}$$

$$\sigma_d = \frac{N_{Ed}}{A_w} = \frac{947.10}{6625} = 0.1430 \text{ kN/cm}^2 = 1.430 \text{ N/mm}^2$$

$$f_t = 0.18 \text{ N/mm}^2 \text{ – prema tablici}$$

$$\tau_R = \frac{f_t}{1.5} \cdot \sqrt{1 + \frac{\sigma_d}{f_t}} = \frac{0.18}{1.5} \cdot \sqrt{1 + \frac{1.430}{0.18}} = 0.359 \text{ N/mm}^2$$

$$H_{RH} = C_r \cdot A_m \cdot \tau_R = 0.9 \cdot 250 \cdot 2650 \cdot 0.359 = 214053.75 \text{ N} = 214.05 \text{ kN}$$

$$V_{RHd} = \frac{H_{RHd}}{\gamma_M} = \frac{214.05}{1.5} = 142.70 \text{ kN} < 340.90 \text{ kN} \rightarrow \text{Ne zadovoljava uvjet!}$$

Provjera nosivosti preostalih zidova smjera X odrađena je u Excelu:

NOSIVOST ZIDOVA NA POSMIK – SMJER X												
Zid	L_w [m]	l_k [m]	N_{Ed} [kN]	M_{Ed} [kNm]	V_{Ed} [kN]	L_c [m]	A_w [cm ²]	σ_d [N/mm ²]	f_{tk} [N/mm ²]	f_{td} [N/mm ²]	V_{RHd} [kN]	
2	1.275	0.25	150.80	11.50	10.50	1.275	3187.50	0.437	0.489	0.326	103.96	Z
3	5.225	0.25	522.30	194.30	107.70	5.225	13062.50	0.400	0.460	0.307	400.53	Z
4	0.300	0.25	39.80	4.20	1.10	0.221	552.68	0.720	0.588	0.392	29.40	Z
5	9.220	0.25	876.30	489.50	242.00	9.220	23050.00	0.380	0.452	0.301	694.68	Z

NOSIVOST ZIDOVA NA VLAČNI SLOM – SMJER X						
Zid	L_w [m]	σ_d [N/mm ²]	τ_R [N/mm ²]	H_{RH} [kN]	V_{RHd} [kN]	
2	1.275	0.437	0.229	65.57	43.72	Zadovoljava!
3	2.650	0.788	0.278	165.96	110.64	Zadovoljava!
4	0.300	0.531	0.238	16.09	10.73	Zadovoljava!
5	2.650	1.322	0.347	206.73	137.82	Ne zadovoljava!

Zid 1 – smjer Y

$$N_{Ed} = 141.90 \text{ kN}$$

$$M_{Ed} = 141.70 \text{ kNm}$$

$$V_{Ed} = 113.80 \text{ kN}$$

$$L = 2.505 \text{ m}$$

$$t_w = 0.25 \text{ m}$$

Karakteriske ziđa – prema tablici

Provjera nosivosti zida 1 (Smjer Y) na posmik

Tlačna duljina zida za omeđeno ziđe:

$$L_c = \left(\frac{L}{2}\right) \cdot \left(1 + \frac{L \cdot N_{Ed}}{6 \cdot M_{Ed}}\right) = \left(\frac{2.505}{2}\right) \cdot \left(1 + \frac{2.505 \cdot 141.90}{6 \cdot 141.70}\right) = 1.78 \text{ m} < 2.505 \text{ m} \rightarrow 1.78 \text{ m}$$

$$A_w = t \cdot L_c = 25 \cdot 178 = 4450 \text{ cm}^2$$

$$\sigma_d = \frac{N_{Ed}}{A_w} = \frac{141.90}{4450} = 0.0319 \text{ kN/cm}^2 = 0.319 \text{ N/mm}^2$$

$$f_{vk,0} = 0.3 \text{ N/mm}^2 \text{ – prema tablici}$$

$$f_{vk} = f_{vk,0} + 0.4 \cdot \sigma_d = 0.3 + 0.4 \cdot 0.319 = 0.428 \text{ N/mm}^2$$

$$f_{vd} = \frac{f_{vk}}{\gamma_M} = \frac{0.428}{1.5} = 0.285 \text{ N/mm}^2$$

$$V_{Rd} = 0.285 \cdot 250 \cdot 1780 = 126825 \text{ N} = 126.83 \text{ kN} > 113.80 \text{ kN} \rightarrow \text{Zadovoljava uvjet!}$$

Provjera nosivosti zida 1 (smjer Y) na vlačni slom

$$L_w = 2.505\text{ m} < H_w = 2.650\text{ m} \rightarrow L_w = 2.505\text{ m}$$

$$\sigma_d = \frac{N_{Ed}}{A_w} = \frac{141.90}{6262.5} = 0.0227\text{ kN/cm}^2 = 0.227\text{ N/mm}^2$$

$$f_t = 0.18\text{ N/mm}^2 \text{ – prema tablici}$$

$$\tau_R = \frac{f_t}{1.5} \cdot \sqrt{1 + \frac{\sigma_d}{f_t}} = \frac{0.18}{1.5} \cdot \sqrt{1 + \frac{0.227}{0.18}} = 0.180\text{ N/mm}^2$$

$$H_{RH} = C_r \cdot A_m \cdot \tau_R = 0.9 \cdot 250 \cdot 2505 \cdot 0.180 = 101452.5\text{ N} = 101.46\text{ kN}$$

$$V_{RHd} = \frac{H_{RHd}}{\gamma_M} = \frac{101.46}{1.5} = 67.64\text{ kN} < 113.80\text{ kN} \rightarrow \text{Ne zadovoljava uvjet!}$$

Provjera nosivosti preostalih zidova smjera Y odrađena je u Excelu:

NOSIVOST ZIDOVA NA POSMIK – SMJER Y												
Zid	L_w [m]	t_w [m]	N_{Ed} [kN]	M_{Ed} [kNm]	V_{Ed} [kN]	L_c [m]	A_w [cm ²]	σ_d [N/mm ²]	f_k [N/mm ²]	f_{td} [N/mm ²]	V_{RHd} [kN]	
2	3.360	0.25	276.40	188.10	228.40	3.062	7656.10	0.361	0.444	0.296	226.83	N
3	2.505	0.25	229.50	158.10	158.10	2.012	5028.94	0.456	0.483	0.322	161.78	N
4	0.555	0.25	52.40	6.00	16.40	0.502	1254.18	0.418	0.467	0.311	39.06	Z
5	1.220	0.25	131.40	54.30	40.70	0.910	2275.37	0.577	0.531	0.354	80.55	Z
6	0.840	0.25	68.60	16.70	16.70	0.662	1653.84	0.415	0.466	0.311	51.37	Z

NOSIVOST ZIDOVA NA VLAČNI SLOM – SMJER Y						
Zid	L_w [m]	σ_d [N/mm ²]	τ_R [N/mm ²]	H_{RH} [kN]	V_{RHd} [kN]	
2	2.650	0.417	0.219	130.58	87.05	Ne zadovoljava!
3	2.505	0.456	0.226	102.12	68.08	Ne zadovoljava!
4	0.555	0.378	0.211	26.38	17.58	Zadovoljava!
5	1.220	0.431	0.221	60.68	40.45	Ne zadovoljava!
6	0.840	0.327	0.201	38.05	25.37	Zadovoljava!

6. LITERATURA

[1] Zorislav Sorić: Zidane konstrukcije, 2016.

[2] Tomislav Kišićek, Zorislav Sorić: Betonske konstrukcije 1, 2014.

[3] Eurocode 6: Design of masonry structures

[4] Nikša Ivanović, Krešimir Tarnik: Zidane omeđene konstrukcije

DONJA ZONA
M=1:50

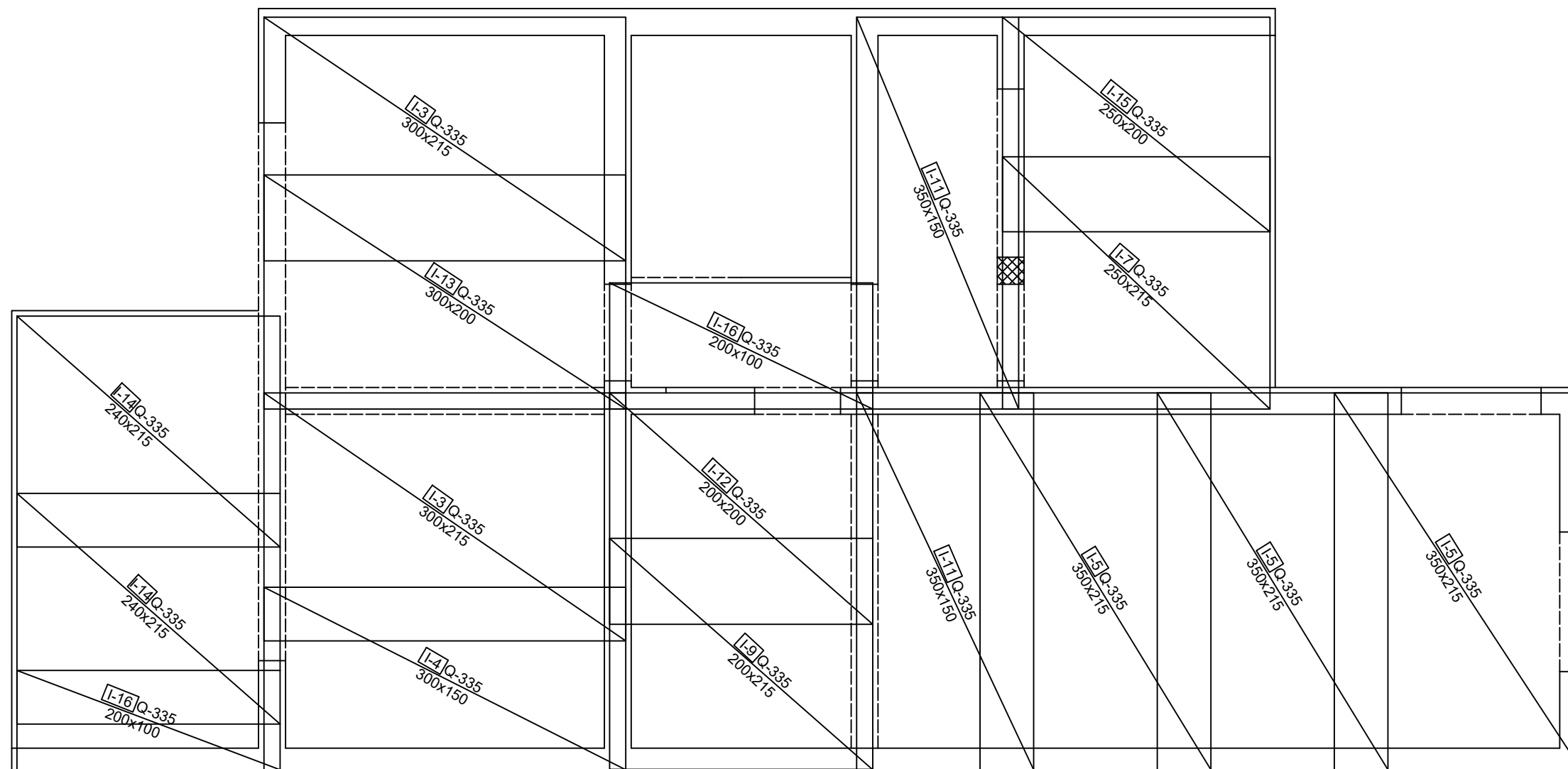

SVEUČILIŠTE U ZAGREBU
GRAĐEVINSKI FAKULTET
Kačićeva 26

SADRŽAJ NACRTA:
Plan armature ploče prizemlja
Donja zona

PREDMET	ZAVRŠNI ISPIT	LOKACIJA:
KOLEGIJ	NUMERIČKO MODELIRANJE KONSTRUKCIJA	ZAGREB
STUDENT	TINO RINKOVEC	MJERILO:
JMBAG	0082064609	1:50
MENTOR	prof.dr. sc. MLADEN MEŠTROVIĆ	AK. GOD.:
DATUM	10.07.2023	2022/23

GORNJA ZONA
M=1:50

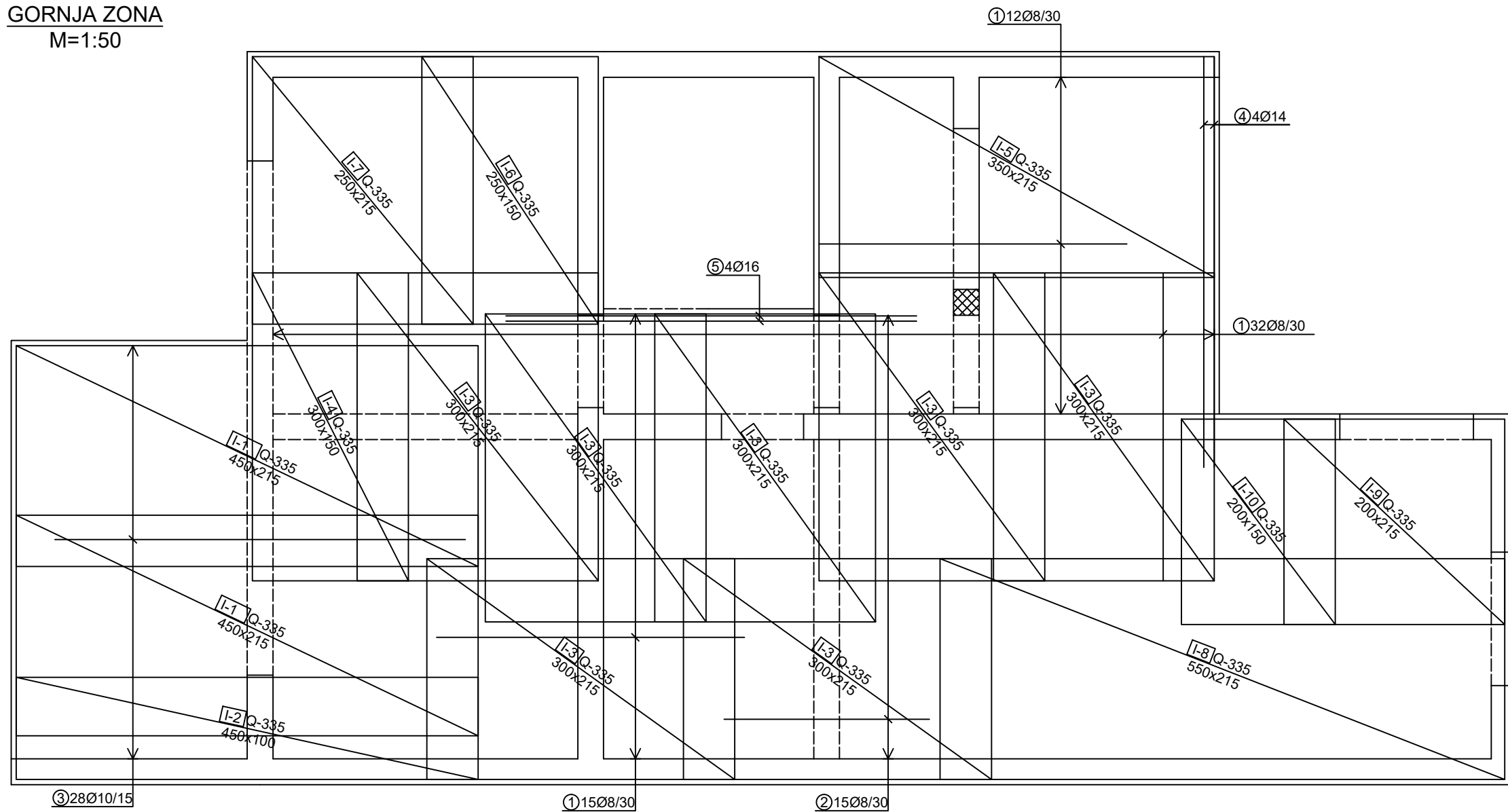

SVEUČILIŠTE U ZAGREBU
GRAĐEVINSKI FAKULTET
Kačićeva 26

SADRŽAJ NACRTA:

Plan armature ploče prizemlja
Gornja zona

PREDMET	ZAVRŠNI ISPIT	LOKACIJA:
KOLEGIJ	NUMERIČKO MODELIRANJE KONSTRUKCIJA	ZAGREB
STUDENT	TINO RINKOVEC	MJERILO:
JMBAG	0082064609	1:50
MENTOR	prof.dr. sc. MLADEN MEŠTROVIĆ	AK. GOD.:
DATUM	10.07.2023	2022/23

POZICIJE ARMATURE I OZNAKE PRESJEKA

M=1:50

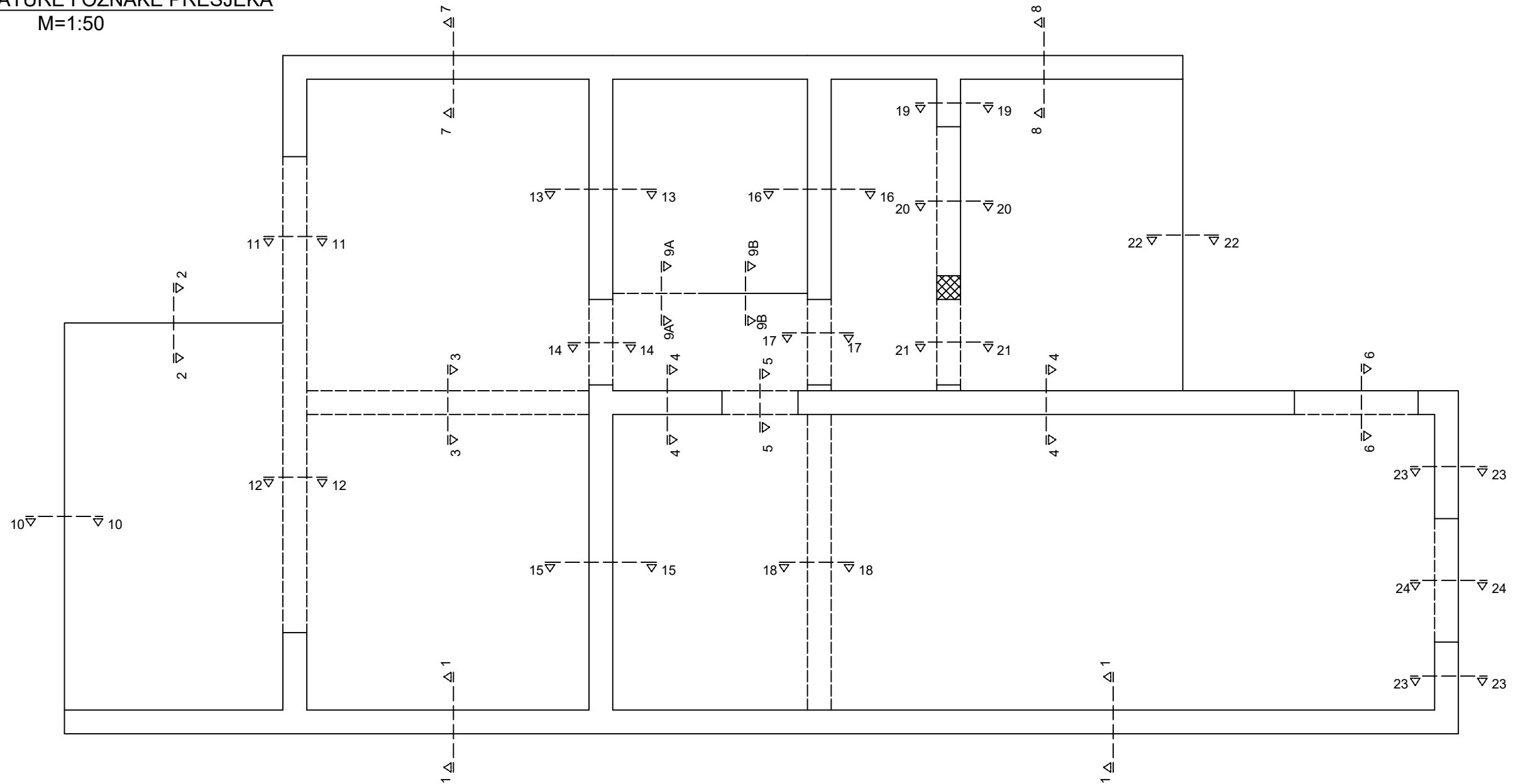

PRESJEK 1-1
M=1:25

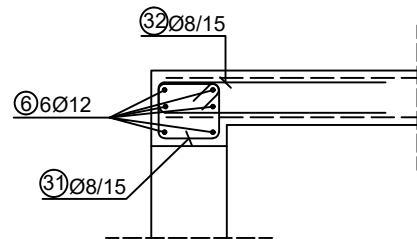

PRESJEK 2-2
M=1:25

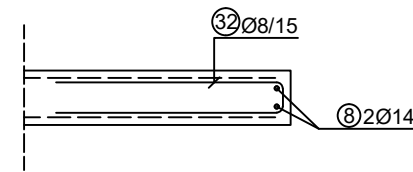

PRESJEK 3-3
M=1:25

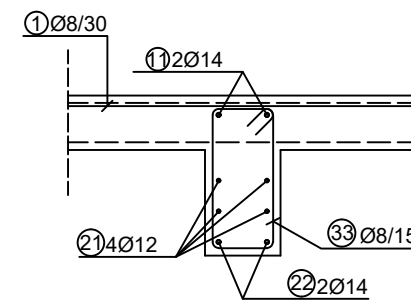

PRESJEK 4-4
M=1:25

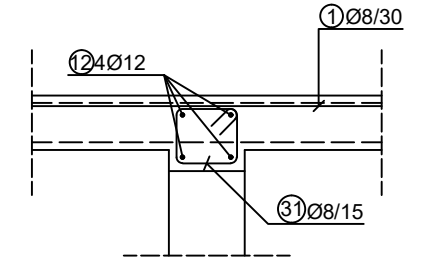

PRESJEK 5-5
M=1:25

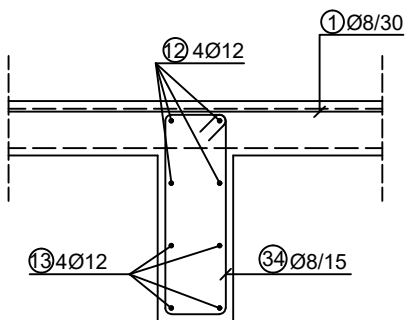

PRESJEK 6-6
M=1:25

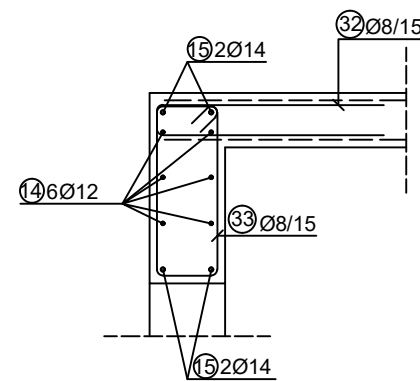

		SVEUČILIŠTE U ZAGREBU GRAĐEVINSKI FAKULTET Kačićeva 26	
		SADRŽAJ NACRTA: Plan armature ploče prizemlja Pozicije armature, oznake presjeka i presjeci	
PREDMET	ZAVRŠNI ISPIT	LOKACIJA: ZAGREB	
KOLEGIJ	NUMERIČKO MODELIRANJE KONSTRUKCIJA	MJERILO: 1:50; 1:25	
STUDENT	TINO RINKOVEC	AK. GOD.: 2022/23	
JMBAG	0082064609		
MENTOR	prof.dr. sc. MLADEN MEŠTROVIĆ		
DATUM	10.07.2023		

PRESJEK 7-7
M=1:25

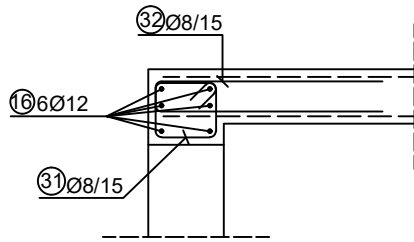

PRESJEK 8-8
M=1:25

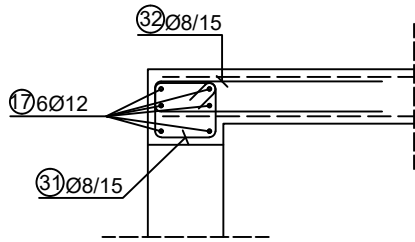

PRESJEK 9A-9A
M=1:25

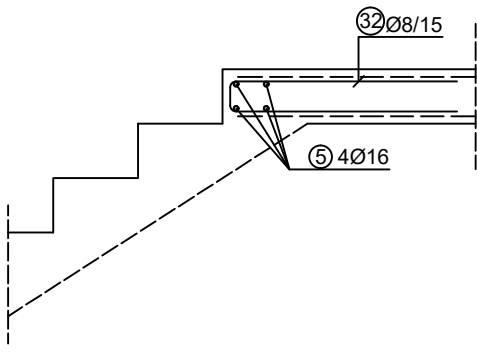

PRESJEK 9B-9B
M=1:25

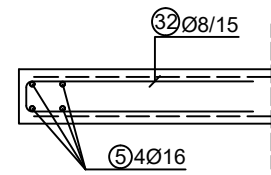

PRESJEK 10-10
M=1:25

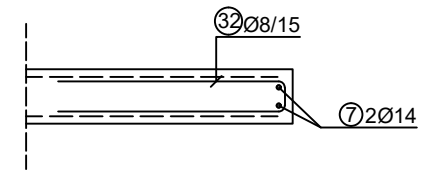

PRESJEK 11-11
M=1:25

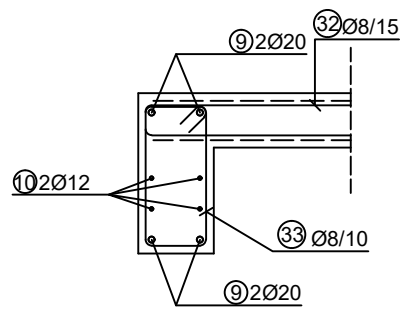

PRESJEK 12-12
M=1:25

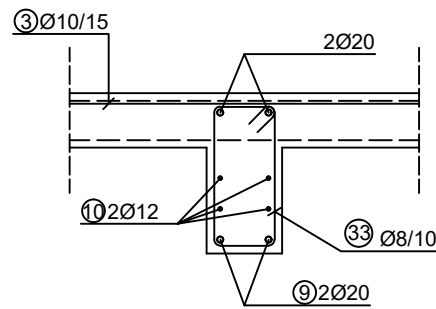

PRESJEK 13-13
M=1:25

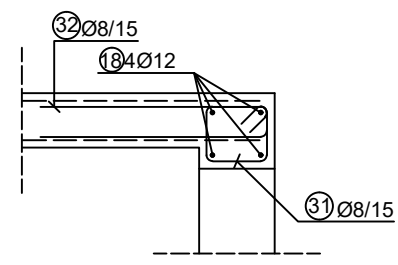

PRESJEK 14-14
M=1:25

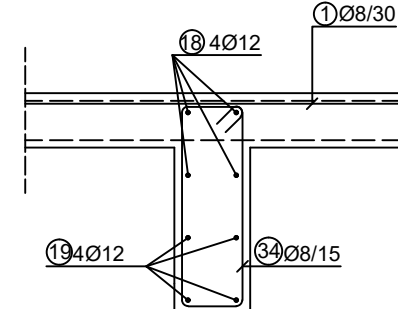

PRESJEK 15-15
M=1:25

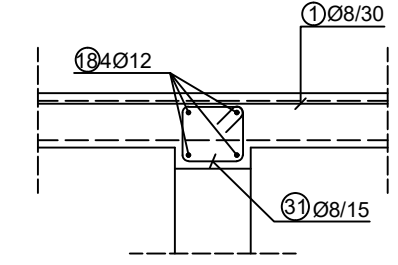

PRESJEK 16-16
M=1:25

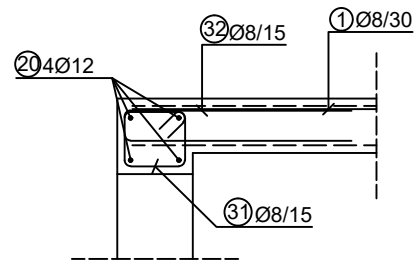

PRESJEK 17-17
M=1:25

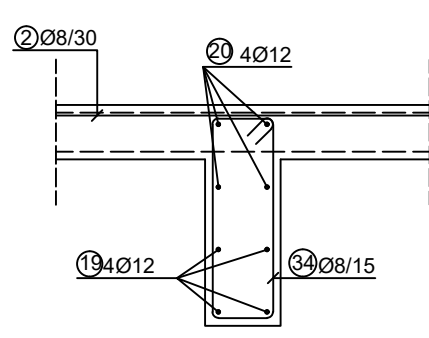

PRESJEK 18-18
M=1:25

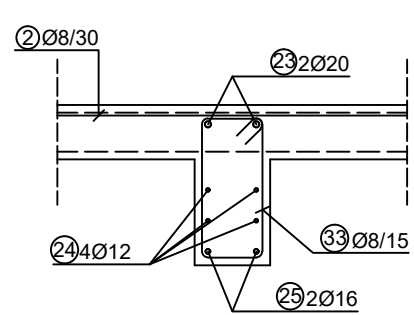

PRESJEK 19-19
M=1:25

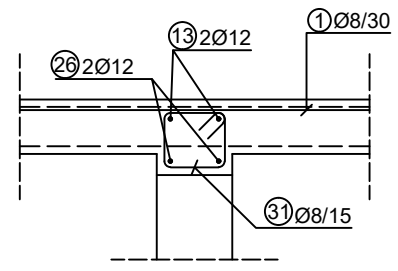

PRESJEK 20-20
M=1:25

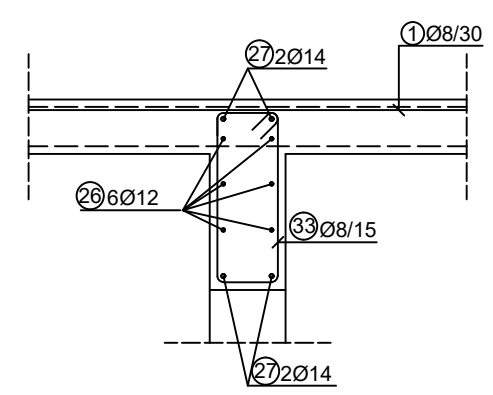

PRESJEK 21-21
M=1:25

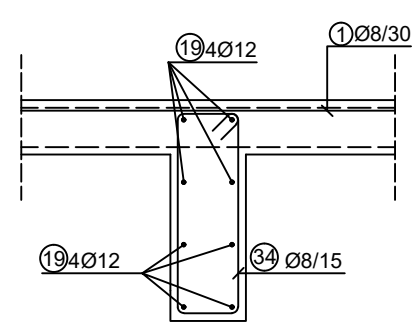

PRESJEK 22-22
M=1:25

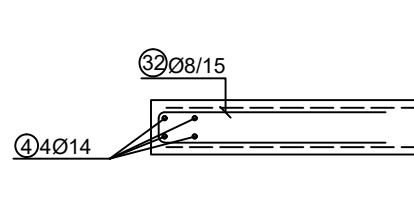

PRESJEK 23-23
M=1:25

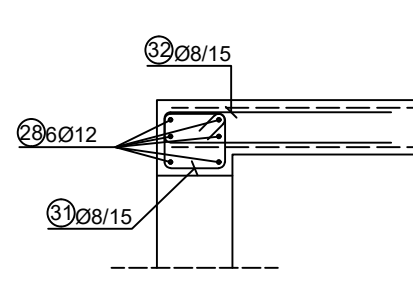

PRESJEK 24-24
M=1:25

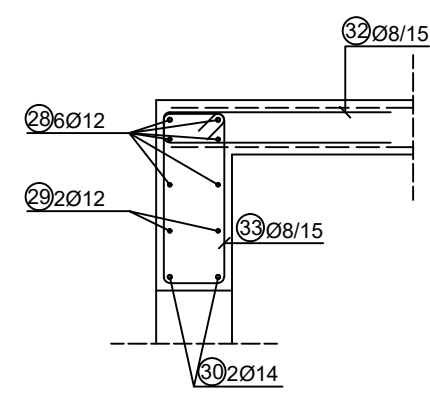

		SVEUČILIŠTE U ZAGREBU GRAĐEVINSKI FAKULTET Kačićeva 26	
SADRŽAJ NACRTA: Plan armature ploče prizemlja Presjeci			
PREDMET	ZAVRŠNI ISPIT	LOKACIJA: ZAGREB	
KOLEGIJ	NUMERIČKO MODELIRANJE KONSTRUKCIJA	MJERILO: 1:25	
STUDENT	TINO RINKOVEC	AK. GOD.: 2022/23	
JMBAG	0082064609		
MENTOR	prof.dr. sc. MLADEN MEŠTROVIĆ		
DATUM	10.07.2023		

ISKAZ ARMATURE

ARMATURNE MREŽE							
POZ.	TIP MREŽE	a [m]	b [m]	A [m ²]	kom.	kg/m ²	UKUPNO [kg]
1	Q-335	4.50	2.15	9.68	2	5.26	101.78
2	Q-335	4.50	1.00	4.50	1	5.26	23.67
3	Q-335	3.00	2.15	6.45	9	5.26	305.34
4	Q-335	3.00	1.50	4.50	2	5.26	47.34
5	Q-335	3.50	2.15	7.53	4	5.26	158.33
6	Q-335	2.50	1.50	3.75	1	5.26	19.73
7	Q-335	2.50	2.15	5.38	2	5.26	56.55
8	Q-335	5.50	2.15	11.83	1	5.26	62.20
9	Q-335	2.00	2.15	4.30	2	5.26	45.24
10	Q-335	2.00	1.50	3.00	1	5.26	15.78
11	Q-335	3.50	1.50	5.25	2	5.26	55.23
12	Q-335	2.00	2.00	4.00	1	5.26	21.04
13	Q-335	3.00	2.00	6.00	1	5.26	31.56
14	Q-335	2.40	2.15	5.16	2	5.26	54.28
15	Q-335	2.50	2.00	5.00	1	5.26	26.30
16	Q-335	2.00	1.00	2.00	2	5.26	10.52
							Σ= 1045.41

ARMATURNE ŠIPKE B500B							
POZ.	SKICA [cm]	Φ [mm]	L [m]	kom.	kg/m	UKUPNO [kg]	
1	300	8	3.00	59	0.405	71.69	
2	200	8	2.00	15	0.405	12.15	
3	400	10	4.00	28	0.634	71.01	
4	400	14	4.00	4	1.242	19.87	
5	400	16	4.00	4	1.621	25.94	
6	750	12	7.50	12	0.911	81.99	
7	420	14	4.20	2	1.242	11.18	
8	230	14	2.30	2	1.242	5.71	
9	660	20	6.60	8	2.536	133.90	
10	660	12	6.60	4	0.911	24.05	
11	350	14	3.50	2	1.242	8.69	
12	840	12	8.40	4	0.911	30.61	
13	100	12	1.00	6	0.911	5.47	
14	190	12	1.90	6	0.911	10.39	

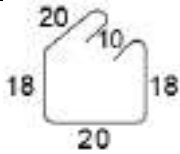
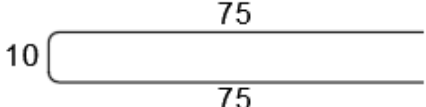
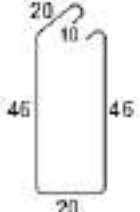
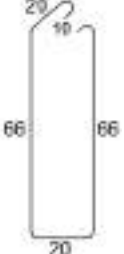
15	<u>190</u>	14	1.90	4	1.242	9.44
16	<u>340</u>	12	3.40	6	0.911	18.58
17	<u>390</u>	12	3.90	6	0.911	21.32
18	<u>710</u>	12	7.10	4	0.911	25.87
19	<u>110</u>	12	1.10	16	0.911	16.03
20	<u>380</u>	12	3.80	4	0.911	13.85
21	<u>320</u>	12	3.20	4	0.911	11.66
22	<u>320</u>	14	3.20	2	1.242	7.95
23	<u>360</u>	20	3.60	2	2.536	18.26
24	<u>310</u>	12	3.10	4	0.911	11.30
25	<u>310</u>	16	3.10	2	1.621	10.05
26	<u>190</u>	12	1.90	8	0.911	13.85
27	<u>190</u>	14	1.90	4	1.242	9.44
28	<u>360</u>	12	3.60	12	0.911	39.36
29	<u>150</u>	12	1.50	2	0.911	2.73
30	<u>150</u>	14	1.50	2	1.242	3.73
31		8	0.96	305	0.405	118.58
32		8	1.60	329	0.405	213.19
33		8	1.52	104	0.405	64.02
34		8	1.92	27	0.405	20.99
$\Sigma = 1162.58$						