

Structural Steel Joints with Bolts in Threaded Holes

Ptiček, Marko; Skejić, Davor; Veljković, Milan; Rizzano, Gianvittorio

Source / Izvornik: Tehnički vjesnik = Technical gazette, 2022, 24(4), 1382 - 1393

Journal article, Published version

Rad u časopisu, Objavljena verzija rada (izdavačev PDF)

Permanent link / Trajna poveznica: <https://um.nsk.hr/um:nbn:hr:237:736936>

Rights / Prava: [In copyright](#) / [Zaštićeno autorskim pravom.](#)

Download date / Datum preuzimanja: **2024-11-28**

Repository / Repozitorij:

[Repository of the Faculty of Civil Engineering,
University of Zagreb](#)



Structural Steel Joints with Bolts in Threaded Holes

Marko PTIČEK*, Davor SKEJIĆ, Milan VELJKOVIĆ, Gianvittorio RIZZANO

Abstract: The application of tubular columns in steel structures offers many advantages. However, this potential has not been fully utilized due to a lack of access for the installation of standard bolts in end-plate beam-to-column joints. Blind bolts are an alternative way of connecting the beam end-plate to hollow section column, for they can be installed and tightened from outside of the column. Standard high strength bolts can be directly screwed into the threaded hole tapped in the column hole wall. Bolts in threaded holes (BTH) - use threads on the bolt hole wall as an anchorage instead of nuts used in standard bolt assemblies. Provisions regarding BTH can be found in the draft version of new Eurocode 3, Part 1-8, including the definition of minimum thread engagement lengths. Parametric study of beam-to-tubular column joint with extended end-plate was conducted in order to analyse the influence of BTH and specific failure modes on overall joint resistance. Minimum thread engagement length limitations were checked for all considered combinations of parameters, and based on these results, an overview of the general applicability of bolts in threaded holes was gained.

Keywords: beam-to-tubular column joint; blind bolts; bolts in threaded holes; EN 1993-1-8; parametric analysis; thread engagement length

1 INTRODUCTION

Compared to H-sections, steel columns with hollow sections possess higher strength-to-weight ratio, superior torsional rigidity and, when filled with concrete, their strength and fire-resistance could be considerably improved further. Moreover, hollow sections are more attractive from the aspect of architectural aesthetics. Regardless of the advantages mentioned above, the potential of the hollow section is not fully utilized due to lack of access for installation of standard bolts in end-plate beam-to-column joints.

Bolted end-plate joints have been widely used in steel frame design and are very popular regarding its ease of fabrication and erection. All elements are prefabricated in steel workshop and thus welding on site can be avoided. When connecting steel beam to an open H-section column, bolted end-plate connection can be easily achieved, Fig. 1a. In the case of hollow section columns, there is no access to inside of the column so the bolt nut cannot be installed. A possible solution is the opening of a temporary hole on the column wall to access the bolts from the inside, Fig. 1b. The temporary hole needs to be closed by welding after the installation of bolts which brings welding residual stress to the column and reduces the construction efficiency. It is also not certain whether the hole can be made in the first place if the column face is not wide enough. Various

solutions which involve welding to the column face can be used instead, e.g., connections with end-plates extended outside the column face or, as shown in Fig. 1c, welded beam segment or equivalent welded plates resulting with beam joining-plate connection being farther from the column face. Another option is welding a channel-shaped element to the hollow section column face along the tips of channel flanges. End-plate connection is bolted onto the web of the channel welded to a tubular column allowing tightening bolts to both sides of the channel [1, 2] and obtaining often a bit less stiff connection than shown in Fig. 1.

Except additional fabrication and accompanying costs, welding close to the corners of cold-formed hollow sections reduces ductility in cold-formed zones and increases the risk of brittle fracture. In order to increase the joint resistance and stiffness, it is often necessary to weld in the areas close to the cold-formed zones at the edges. Hot-finished hollow sections are more suitable for welding which has to be checked considering metallurgical properties of the product. On the other hand, cold-formed hollow sections are available at competitive prices, but their mechanical properties and ductility vary around the section due to cold-forming process. Therefore, EN 1993-1-8, Clause 4.14 [3] and EN 1993-1-8 corrigendum dated July 2009 [4] state provisions and conditions that need to be fulfilled for welding in cold-formed zones.

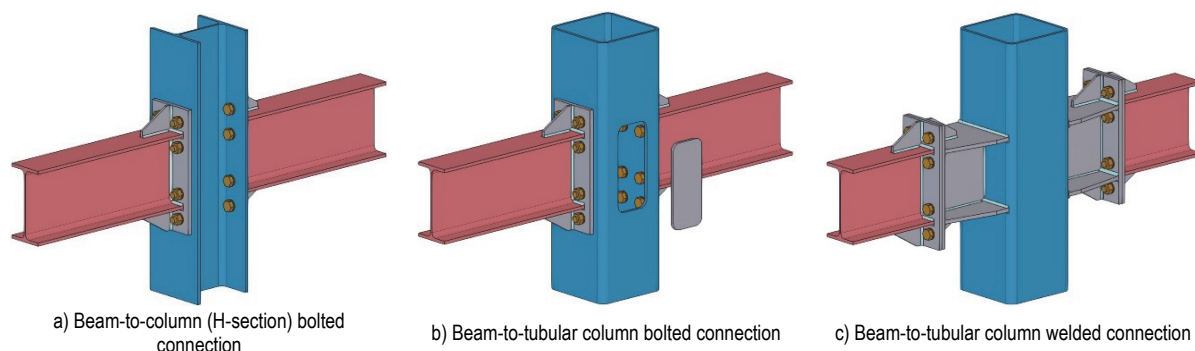

Figure 1 Beam-to-column joints

Blind bolts are an alternative way of connecting the beam end-plate to hollow section column for they can be screwed and tightened from outside of the column.

Currently, there are several blind bolt systems used, such as Hollo-bolt, Extended Hollo-bolt, Ajax ONESIDE, Molabolt, BOM fastener (Blind, Oversized Mechanically

locked), Blind Bolt, Huck Bolt, Fig. 2a to Fig. 2d. Another type of blind bolt connecting can be achieved with one-sided tightening in a threaded hole manufactured by flow drilling technique, Fig. 2e. The friction between the drill and the steel plate creates a hole thereby melting the plate.

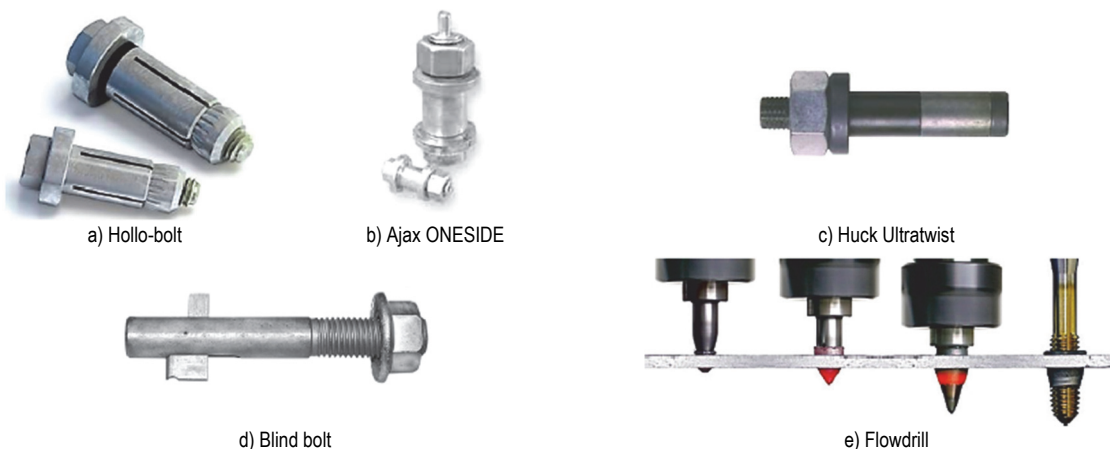

Figure 2 Blind bolt systems[5]

For the flowdrill bolting principle to be applied to steel plates of any thickness, the bolt hole is drilled using a common magnetic drill first and then threads are tapped on the hole wall. Standard high strength bolts can be used as blind bolts, directly screwed into the threaded hole from the outside of the hollow section column. This particular type of bolt assembly bolts in threaded holes, denoted herein as BTH use threads on the bolt hole wall as an anchorage instead of nuts used in standard bolt assemblies. BTH connections can be divided into two groups considering the threaded hole type: (i) through hole, Fig. 3a and (ii) blind threaded hole, Fig. 3b. Threads are fabricated by cutting or forming taps. Cutting is a process where the material is removed from the hole using tools

This increases the plate thickness locally and now the thread can be tapped. Conventional bolts are then used in this tapped hole. The Flowdrill technique is only applicable for steel plates thinner than 12,5 mm. A detailed review of the aforementioned blind bolt systems can be found in [5].

designed to shape a finished thread in the intended geometry. Forming creates threads by displacement of material within the hole.

Apart from application in beam-to-hollow section column connections, BTH can also be used in other cases where nut installation is out of reach. Engineers in practice often resort to such connections as welded nuts due to a lack of ability to utilize the standardized connections. Using this type of "improvised" connections with incompatible welded materials is not in accordance with EN 1090-2[6] and such solutions can lead to various problems like increased risk of weld failure by brittle fracture or fatigue.

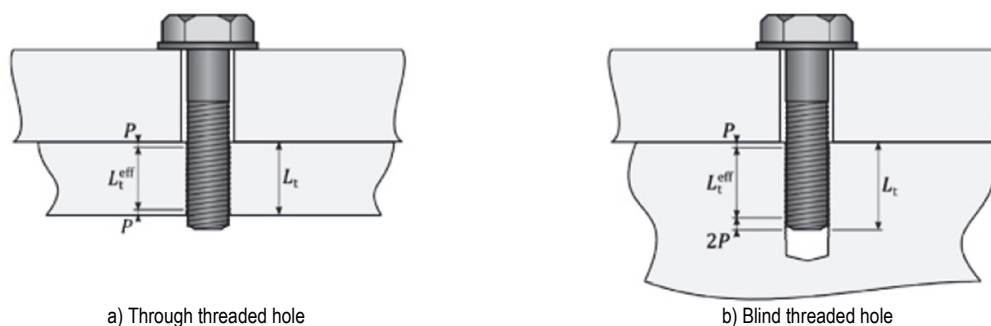

Figure 3 Bolts in threaded holes connection types [7]

After reviewing the existing literature [8-18], it can be seen that recent experimental investigation of bolts in threaded holes for structural application started with tensile strength tests on T-stubs. Besides being practical for conducting tests, T-stubs are already integrated into Eurocode 3 [3] as a design method for bolted connections which can be expanded with the implementation of BTH.

Zhu et al. [8] conducted tensile strength tests on T-stubs connected with bolts in threaded holes. In addition to three existing failure modes of T-stubs from EN 1993-1-8 [3], two new failure modes were proposed: (1) hole thread failure and (2) T-stub flange yielding accompanied with hole thread failure. The design equations for the tension strength of failure modes were given. Liu et al. [9]

continued the investigation in order to verify the two new failure modes and corresponding design equations. Parametric study showed that analysed specimens were still in the elastic state under the design load. The design method in EN 1993-1-8 [3] and the proposed design equations for two new failure modes were able to predict the tension strength on the safe side. Hole thread failure mode is discussed in detail in Section 3.2.

Further analysis of BTH connected T-stubs under tension was carried out by Wulan et al. [10] with Finite Element Model (FEM) simulation. Results were verified with test results and showed that two new failure modes caused by threads failure may appear and BTH connected T-stubs had sufficient tensile capacity to avoid premature

thread failure. Yield line patterns of T-stubs connected with BTH which occur when T-stubs fail due to complete flange yielding were investigated by Zhang et al. [11] and T-stub flange width was shown to be the main factor that affects the yield line patterns. Wulan et al. [12] carried out experimental studies on behaviour of T-stubs connected with BTH under monotonic and cyclic loads and when compared to the monotonic tests, the cyclic load caused stiffness degradation and made threads on the bolt hole wall more vulnerable to failure.

Wang et al. [13] conducted tests on BTH end-plate connection of a beam-to-hollow section column under static bending moment and proposed design methods for calculating the bending moment capacity of BTH end-plate connection under failure modes of hole thread failure, end-plate yielding and column wall yielding. Zhang et al. [14] carried out numerical analyses on yield line patterns of end-plate connection with BTH to square hollow section (SHS) column under tension and proposed a new yield line pattern for connections failed by column wall yield failure with corresponding design method.

Shear behaviour of lap connections with BTH was examined by Wang et al. [15]. Experimental and numerical investigations showed that bolt would tilt if the thickness of the base plate is smaller than the bolt diameter. Slight differences between the shear resistance of lap connections with BTH and standard bolts with nuts led to the conclusion that the screwed shear plate could replace the traditional nut in engineering applications.

Latour and Rizzano [16] developed FE models and conducted parametric studies in order to provide design rules for the behaviour of BTH in tension and shear. The collected data was used to provide the prediction of BTH connection resistance and design rules for implementation of BTH in new version of Eurocode were suggested.

Wang et al. [17] and You et al. [18] conducted tests and investigated the tension behaviour of BTH connected T-stubs at ambient and elevated temperatures. Unfavourable threads failure did not occur at high temperatures which demonstrated the good applicability of BTH in a fire situation.

There is still a lack of knowledge concerning the behaviour of threaded holes in pure tension. Experimental and numerical investigations of hole thread failure as a governing mode are needed and should be compared to other failure modes bolt breaking and bolt thread failure. Specific factors influencing the threaded hole tensile resistance and overall connection behaviour thread length and mechanical properties of the threaded hole need to be analysed in detail. This is important since thread length is restricted by the thickness of the material where bolts are inserted. Also, unlike internal threads tapped in the nut, which is made of high strength steel, threaded hole material is identical to that of the surrounding steel plate.

Taking all of this into account, minimum threaded hole depth (i.e., minimum thread engagement length), should be defined in order to ensure safe and reliable application of BTH in structural steel joints. Length of engagement is discussed in Section 2 as a part of an ongoing discussion regarding the implementation of connections with bolts in threaded holes into the new revision of Eurocode 3.

In the case of beam-to-tubular column joints with BTH, the connection resistance highly depends on the

column wall thickness and steel grade. For columns with relatively thin walls, threaded holes can easily be the weakest component. On the other hand, conservative specifications for the length of engagement can limit their overall applicability. Considering the mentioned potential problems, bolts in threaded holes and specifically their application in end-plate connections to tubular columns are investigated in this paper. Failure modes are presented in Section 3 and used in parametric study to determine the influence of threaded hole tension resistance and thread engagement length limitations on overall joint resistance and general applicability of BTH in structural steel joints.

2 THREAD ENGAGEMENT LENGTH

General design principle of bolt and nut assemblies subjected to tensile load used in steel structures is based on work by Alexander [19] who defined a model for calculation of three possible failure modes under tensile overload: (i) bolt breaking, (ii) external thread stripping (bolt) and (iii) internal thread stripping (nut or threaded hole). Bolt breaking can occur in cases of sufficient thread engagement length and relatively high internal thread material strength, while thread stripping generally occurs when thread engagement is too short. The strength ratio between the mating threads defines the thread stripping failure mode. If the tensile strength of internal threads exceeds the tensile strength of external threads, the failure mode will be bolt thread stripping and vice versa.

External and internal thread stripping load, i.e., thread stripping strength for bolt (F_{Sb}) and nut (F_{Sn}) worked out by Alexander [19] is given by:

$$F_{Sb} = 0,6 \cdot f_{ub} \cdot A_{Sb} \cdot C_1 \cdot C_2 \quad (1)$$

$$F_{Sn} = 0,6 \cdot f_{un} \cdot A_{Sn} \cdot C_1 \cdot C_3 \quad (2)$$

where: f_{ub} is bolt material tensile strength, f_{un} is nut material tensile strength, A_{Sb} is bolt threads shear area, A_{Sn} is nut threads shear area, C_1 is modification factor for nut dilation, C_2 and C_3 are modification factors for thread bending effect.

Since thread stripping strength is basically shear strength, factor 0,6 used in both equations is the required shear-to-tensile strength ratio. This ratio depends on the material and each property class of bolts is defined by a different value. Recommended shear-to-tensile strength ratios for different property classes of bolts can be found in VDI 2230 [20]. The value of 0,6 is the minimum recommended, therefore giving results on the safe side.

Bolt breaking is preferable of the three failure modes under tensile overload since it gives an obvious indication of a tensile failure, while thread stripping is difficult to detect. Typical bolt failure modes from tests on stiffened flange cleat joints conducted by Skejić et al. [21] are shown in Fig. 4. Generally, a bolt and nut assembly designed in accordance with ISO 898-1 [22] and ISO 898-2 [23] should not fail by thread stripping, meaning that an optimized bolted joint is capable of utilizing the full strength of the bolt. This principle can be applied to the design of threaded holes and the definition of minimum thread engagement length, having in mind properties of the plate with threaded

hole: bolt resistance should be the minimum value between these three failure modes in order to guarantee the over-

resistance of the threads so as to favour a more ductile and easily detectable failure mode.

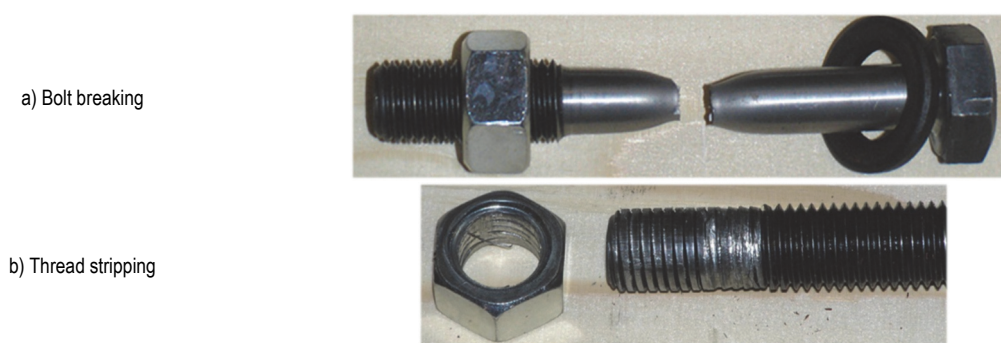

Figure 4 Bolt failure [21]

Based on the above-mentioned principle and using Eq. (1) and Eq. (2), Rodier [7] derived expressions for the minimum thread engagement length as a part of design provisions development and standardization of bolts in threaded holes. As mentioned, neither external nor internal thread stripping should be the leading failure mode, or as follows:

$$\min\{F_{bs,Rd}; F_{ns,Rd}\} \geq F_{t,Rd} \quad (3)$$

where: $F_{bs,Rd}$ is external (bolt) thread stripping resistance, $F_{ns,Rd}$ is internal (nut or threaded hole) thread stripping resistance and $F_{t,Rd}$ is bolt tensile strength.

Length of engagement generally equals the nut height and in the case of threaded through hole, it equals the thickness of tapped material (see Fig. 3). However, the thread contact is established at a slightly shorter effective length $L_{t,eff}$. According to VDI 2230 [20], the difference is the ineffective part of thread length with no thread contact (countersink, chamfer) and parts of the thread which are not fully load-bearing (the tip). This leads to longer length of engagement and additional safety when bolt and threaded hole have a significant tensile strength difference. As shown in Fig. 3, this ineffective length was taken by Rodier as (i) twice the thread pitch P for through hole and (ii) three times the thread pitch P for blind hole.

With everything considered, an expression for the minimum length of engagement (L_t) proposed by Rodier [7] for through hole is given by:

$$L_t \geq \max \left\{ \begin{array}{l} 1,0 d \\ 0,45 d \left(\frac{2}{3} + \frac{f_{ub}}{f_u} \right) \end{array} \right. \quad (4)$$

where d is the nominal bolt thread diameter and f_u is the ultimate tensile strength of threaded hole steel. Fig. 5 shows graphical representation of thread engagement length given in relation to d and f_u with 8.8 and 10.9 bolts for through threaded holes.

A few notable points need to be highlighted regarding Eq. (4). The first part, $1,0d$; is derived from the condition that bolt thread stripping resistance needs to be at least as bolt tensile strength, while the second part is derived from the internal thread stripping condition. Since the design rules for BTH connections need to be standardized and

used in everyday engineering practice, several simplifications were used to derive this straightforward and compact equation. Both external and internal thread stripping resistance were reduced using factor 0,85 from EN 1993-1-8, Cl. 3.6.1 (3) [3]. It states there that this factor should be used to reduce the resistance of bolts with cut threads in shear and/or tension if the threads comply with EN 1090 [26, 6]. Again, this is an additional safety, but increasing thread engagement length may negatively affect the applicability of BTH. Furthermore, as can be seen from Fig. 5, the first condition from Eq. (4), which makes the horizontal parts on the right side of the graphs, can consequently limit the BTH application considering that engagement length should be at least equal to the bolt diameter even for high strength steel (HSS). The left part of the graph for lower values of steel tensile strength f_u , derived from the internal thread resistance, requires engagement lengths significantly higher than the bolt diameter.

Likewise, minimum thread engagement length is considered in VDI 2230 [20]. It is also based on the condition that internal thread stripping resistance needs to be at least as bolt tensile strength, but unlike Rodier [7], external (bolt) thread resistance condition is not taken into consideration. Length of engagement is derived without excessive simplifications using expressions for failure modes by Alexander [19] and ineffective length was taken as twice the thread pitch P . Fig. 5 illustrates the minimum thread engagement length by VDI 2230 [20] calculated assuming shear-to-tensile strength ratio as 0,6 and modification factors C_1 and C_3 as 1,0. The results obtained are almost exactly as values from Rodier [7], but for higher values of f_u they fall below the value of $1,0d$ due to lack of external thread resistance condition. Although useful for detailed insight and a better understanding of this issue, engagement length by VDI 2230 [20] will not be discussed afterwards nor used in the further parametric analysis. Blind bolts are not covered by the actual European standard for the design of steel joints EN 1993-1-8 [3]. Work on the new version of Eurocode has engaged and certain provisions concerning BTH can be found in the draft version of new Eurocode –prEN 1993-1-8:2020 [25] (denoted prEN 1993-1-8 onwards). Unlike many commercial products on the market, BTH will therefore be practically the only bolting system implemented in steel design provisions without standardized nut. The most interesting novelty in the draft version of the new Eurocode

[25] regarding this topic is the definition of minimum thread engagement lengths (L_t) shown here in Tab. 1 and defined in relation to bolt diameter d .

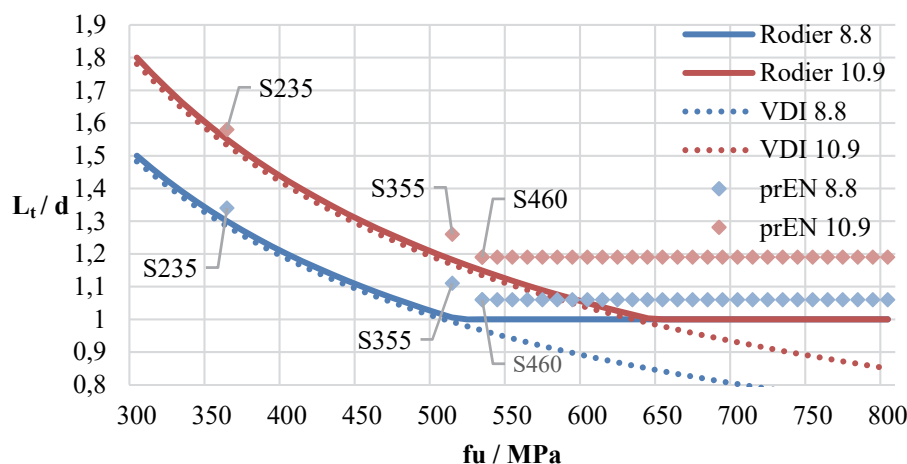

Figure 5 Minimum thread engagement length by Rodier [7], VDI 2230 [20] and prEN [25] for through threaded hole for different bolt hole material grade

Table 1 Minimum thread engagement lengths according to prEN 1993-1-8 [25]

Bolt quality class	L_t/d for steel of grade		
	S235	S355	\geq S460
4.6	1,00	1,00	1,00
5.6	1,02	1,00	1,00
8.8	1,34	1,11	1,06
10.9	1,58	1,26	1,19

Minimum thread engagement lengths according to prEN1993-1-8 [25] are defined by steel grade (i.e., nominal values of yield strength f_y), unlike aforementioned works and provisions which are based on ultimate tensile strength f_u . This definition by steel grade enables an easy-to-use design. Besides, prEN1993-1-8 [25] requires BTH to conform to the requirements of EN 15048 series [26, 27] for non-preloaded applications and EN 14399-2 [28] for preloaded applications, meaning that BTH should be treated as standard bolts and designed using regular expressions.

When compared to values from Rodier [7], values given in Tab. 1 are similar, yet more conservative, see Fig. 5. It can be clearly seen that required minimum thread engagement lengths are noticeably higher than the diameter of applied bolt for commonly used steel grades S235 and S355 and bolt classes 8.8 and 10.9. Hence, in the case of tubular column connections with BTH, column wall thickness should be higher than the bolt diameter or column flange should be strengthened by additional welded plates. All high strength steel (HSS) grades, above and including S460, are combined in a single requirement by bolt quality class, see Tab. 1. As a result, HSS grades are limited to the same values of minimum thread engagement length. And considering only 8.8 and 10.9 bolts, values for all HSS are beyond the value of 1,0 proposed by Rodier [7].

Considering the facts stated above, the application of BTH in tubular column connections could be problematic and, in many cases, limited since the standard column wall thickness ranges up to 12 and 16 mm for larger square/rectangular hollow sections. Further research is needed in order to provide a better understanding and verification of the minimum thread engagement lengths by means of experimental and numerical analysis.

Consequently, the first step in this research is to perform analytical parametric analysis considering lengths of engagement provided by Rodier [7] and prEN 1993-1-8 [25]. The analysis is described in Section 4 and it provides a general view of the applicability of BTH connections on common tubular columns.

3 FAILURE MODES OF BEAM-TO-TUBULAR COLUMN JOINTS

3.1 General Failure Modes of Blind-Bolted Joints On Tubular Columns

Current EN 1993-1-8 [3] does not provide design rules for blind bolted beam-to-tubular columns connections, although several suggestions by different authors can be found in literature [29, 5]. Generally, for blind bolted joints with extended end-plate, failure modes that need to be considered are tension and shear resistance of bolts, bolt bearing for end-plate and column face, column face punching shear, column face in bending, column web crippling and, end-plate in bending. Hole thread failure (i.e., internal thread stripping) is an additional failure mode that should be considered when bolts are clamped by threaded holes, which is the case with flowdrill systems and bolts in threaded holes.

A brief description of failure modes relevant for parametric study is given below. Main focus of the analysis is related to end-plate joints in bending and the behaviour of the joint tension zone. Thus, shear and bolt bearing failure modes will not be considered. Hole thread failure is discussed separately in detail.

3.1.1 Bolts in Tension

The design tension resistance of bolts is given by well-known expression from EN 1993-1-8 [3]:

$$F_{t,Rd} = \frac{0,9 f_{ub} A_s}{\gamma_{M2}} \quad (5)$$

where f_{ub} is the ultimate tensile strength of a bolt, A_S is the tensile stress area (threaded portion of the bolt) and partial factor $\gamma_{M2} = 1,25$.

3.1.2 Punching Shear

Punching shear criterion for connections with bolts in threaded holes can be considered similar to systems with bolts in flowdrilled holes. Several suggestions for the calculation of the punching shear resistance of the flowdrill systems are given. CIDECT Design guide 9 [29] defines the punching shear resistance of a flowdrilled RHS. Weynand et al. [30] proposed the punching shear capacity for flowdrill system bolt group. Additionally, a general punching shear resistance is defined in EN 1993-1-8 [3].

3.1.3 Column Face Bending

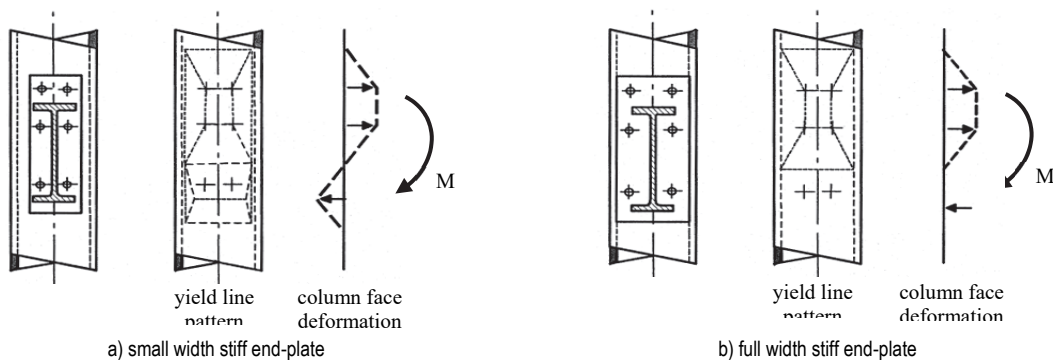

Figure 6 Column face yield line patterns [29]

Ghobarah et al. [31] studied moment-rotation relationship of blind bolted connections on tubular columns and developed two yield mechanisms for column flange on the tension side of the connection. Column flange and corresponding yield loads were proposed.

Park [32] conducted analytical and numerical studies of the behaviour of bolted end-plate connections to rectangular hollow section (RHS) columns using flowdrill bolts and their applications in semi-continuous frame design. Models with different widths of deformable clear column face were analysed and results compared with the test results. Parametric study results suggest that width adopted by Ghobarah et al. [31], $b - t_{c,w}$, underestimates the strength. Therefore, Park proposed the new width of column clear face as $b - 4t_{c,w}$. Bending strength equations for linear, circular, and newly derived elliptical yield mechanisms were given, thereby suggesting separate equations for bolt group and bolt row failure.

Column face resistance beyond bending strength determined from yield line mechanisms was also investigated by Park [32], both for hollow and concrete-filled RHS. Column sidewalls provide support for the column face in bending. Thus, the column face is able to develop tensile membrane action. By using the principle of virtual work, Park related the failure load of the column face to its deformation and derived membrane action resistance for bolt group and bolt row.

3.1.4 Column Web Crippling

Although not dependent on BTH or bolts in general, beam joints on tubular columns should be checked for web

Column face bending (yielding) is classified by CIDECT Design guide 9 [29] as a relevant criterion for designing I-beam-to-RHS column bolted connections subject to bending and design criterion is given. This criterion and consequently yield line patterns depend on end-plate width relation to the width of the RHS column. When the end-plate width is smaller compared to the column face width, the column face compression area will be pushed in and the tension area will be pulled out, Fig. 6a. On the other hand, having end-plate width equal to the RHS column face width increases joint stiffness and column face bending resistance. Yield lines will be in this case formed only in the tension zone, Fig. 6b, provided the crippling strength of the column walls is not governing failure mode.

crippling. According to CIDECT Design guide 9 [29], column web crippling can be assessed using the following expression:

$$N_{c,w} = 2f_{c,y}t_{c,w}(t_{b,f} + 2t_p + 5t_{c,w}) \quad (6)$$

where: $f_{c,y}$ is column yield strength, $t_{c,w}$ is column wall thickness, $t_{b,f}$ is beam flange thickness, and t_p is end-plate thickness.

3.1.4 End-Plate Bending

The study mentioned above on blind bolted connections on tubular columns by Ghobarah et al. [31] also suggests two different yield line mechanisms by which the end-plate failure can occur, Fig. 7. Mechanism 1 is the pure end-plate yielding, while Mechanism 2 is a combined failure mode where both the end-plate plastic moment resistance and the bolt tension resistance have simultaneously been reached.

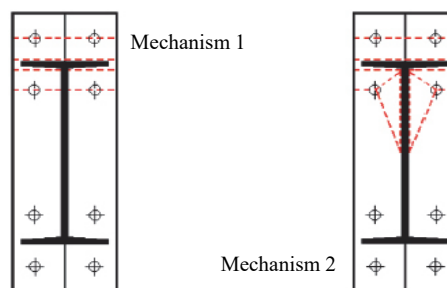

Figure 7 End-plate yield line mechanisms[5]

According to EN 1993-1-8 [3] end-plate resistance can also be calculated following the design method for bolted T-stubs in tension. Each individual bolt-row or group of bolt-rows required to resist tension are considered as equivalent T-stubs and calculated for three possible failure modes. The resistance is taken as the minimum of the values of the three modes considered.

3.2 Hole Thread Failure

Beam-to-tubular column joints with BTH need to be checked for potential stripping of internal threads in column tapped holes. Hole thread stripping is an undesirable failure mode as it can cause the premature connection failure and therefore should be avoided at the design stage. Expressions proposed by Zhu et al. [8] are used for parametric analysis in this study as corresponding design equation. The resulting tension force in the joint, which is transferred from bolts to column face threads, can lead to thread shear failure or thread bending. Column face thread stripping resistance is the minimum value of the aforementioned two, as follows:

$$F_{s,Rd} = \min(F_{s,1,Rd}, F_{s,2,Rd}) \quad (7)$$

where $F_{s,1,Rd}$ is the shear strength of a thread and $F_{s,2,Rd}$ is the bending strength of a thread:

$$F_{s,1,Rd} = A_v f_{yv,p} \quad (8)$$

$$F_{s,2,Rd} = \frac{W f_{y,p}}{b_s} \quad (9)$$

$f_{yv,p}$ and $f_{y,p}$ are shear and yield stress, respectively. A_v is the total effective shear area of the hole threads and the plastic bending modulus W is adopted, as follows:

$$A_v = \pi d h_s \quad (10)$$

$$W = \frac{\pi d h_s^2}{4} \quad (11)$$

d is the external diameter of the bolt thread. b_s and h_s are height and width of internal thread respectively, Fig. 8, both depending on the thread type. It was assumed that the thread shear failure would occur at the thread root (area A_v).

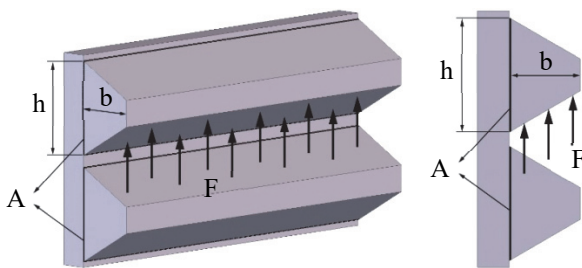

Figure 8 Force on the contact area between threads

The reason for implementing the design method proposed by Zhu et al. [8] in parametric analysis is it being a part of a recent and ongoing study where the applicability

of BTH connections under static load was demonstrated. Subsequently, the proposed hole thread failure expressions were verified experimentally by Liu et al. [9] and numerically by Wulan et al. [10]. The latter also confirmed the assumption that the thread shear failure would occur at the thread root. It should be noted that all aforementioned publications primarily focused on T-stub failure modes, without specific investigation of minimum thread engagement length and the principle established in Section 2.

Nevertheless, FEM simulation by Wulan et al. [10] precisely showed the relationship of failure modes to the bolt diameter and T-stub flange thickness, two key geometric factors for the hole thread strength. Greater flange thickness with threaded holes means longer thread engagement length, hence higher thread stripping resistance. In the case of flange thickness being greater than the bolt diameter, the hole thread resistance was higher than the tension resistance of bolts, which is in accordance with the thread engagement principle from Section 2. On the other hand, when the flange thickness was smaller than the bolt diameter, the hole thread resistance was lower than the tension resistance of bolts. Likewise, flange yielding with hole thread failure was also lower than the bolt failure with yielding of the flange. However, the remaining T-stub failure mode, complete flange yielding, was shown to have the lowest resistance of all, meaning that the connection failure by hole thread stripping could be avoided regardless of the thread engagement length.

4 PARAMETRIC ANALYSIS

4.1 Scope of Analysis

Parametric study conducted herein is the continuation of the work by Javora and Skejić[5] where the resistance of beam-to-column joints with different blind bolt systems was assessed. In the meantime, the idea of implementation and standardization of bolts in threaded holes, as well as HSS in general, emerged. This analysis aims to check the applicability of bolts in threaded holes in beam-to-tubular column connections. Therefore, a beam-to-column joint with extended end-plate shown in Fig. 9 is analysed.

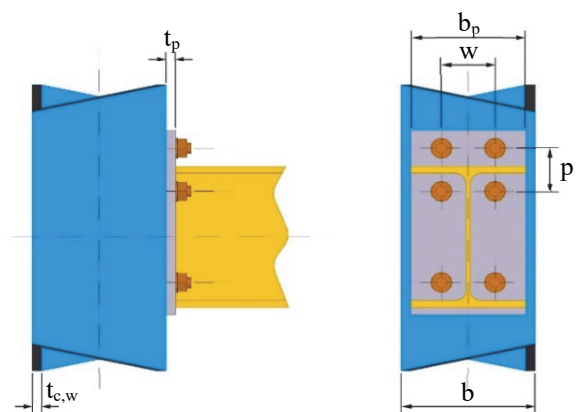

Figure 9 Analysed beam-to-column joint with an extended end-plate

Square hollow section (SHS) 200 × 200 column and IPE 300 beam were selected. Varied geometrical and mechanical parameters used are given in Tab. 2, making a

total of 3840 combinations. All the considered combinations of parameters are checked for minimum thread engagement length limitations provided by prEN 1993-1-8:2020 [25] and Rodier [7]. Column section and the accompanying wall thicknesses were selected from the steel catalogues available on the market. The ultimate tensile strength f_u for each considered steel grade was taken as the minimum value defined in EN 10219-1 [33] and EN 10219-3 [34]. The geometry of threads from Fig. 8 used for calculation of hole thread failure was assumed to be $h_s = 7P/8$ and $b_s = (D - D_1)/2 = 5H/8$, as defined in ISO 68-1 [35].

Table 2 Variation of parameters in the analysis

Column steel grade	S235; S355; S460; S500; S550; S600; S650; S700
Column wall thickness $t_{c,w}$ / mm	5; 6,3; 8; 10; 12,5; 16
Bolt size	M12; M16; M20; M24
Bolt grade	4.6; 5.6; 8.8; 10.9
End-plate steel grade	S355
End-plate thickness t_p / mm	6; 8; 10; 12; 15
Horizontal bolt distance w / mm	100
Vertical bolt distance p / mm	100

Analytical expressions presented in Section 3 were used to determine the governing failure mode, i.e. the joint resistance in bending. Minimum thread engagement lengths for each combination of parameters were calculated using Eq. (4) and limitation given in Tab. 1. Failure modes of beam-to-tubular column joint in bending with BTH end-plate connection considered herein are:

- Failure Mode 1: Bolts in tension.
- Failure Mode 2: Hole thread failure.

- Failure Mode 3: Punching shear.
- Failure Mode 4: Column face bending.
- Failure Mode 5: Column web crippling.
- Failure Mode 6: End-plate bending.

Obtained punching shear resistance values were shown to be higher than those of hole thread failure for all parametric combinations. Also, web crippling was not the governing failure mode for any combination considered. Consequently, both punching shear and web crippling will not be considered as relevant. The remaining four failure modes are considered in further discussion.

4.2 Results and Discussion

The governing failure mode is taken as the minimum value of the four failure modes considered as relevant. The distributions of governing failure modes are shown in Fig. 10. First of all, overall results should be discussed. End-plate bending and column face bending make the vast majority of failure modes considered. Given the input parameters only S355 steel grade used for end-plates and eight types of steel grades including HSS for columns a higher number of end-plate bending failures is expected. Besides, for the same value of $t_{c,w}$ and t_p , end-plate bending resistance is lower than column face bending. Tensile failure of bolts occurs in 5% of cases, specifically for M12 and M16 bolts of lower quality grade combined with column walls and end-plates of higher thickness. Threaded holes turned out to be the weakest component only in 1% of cases.

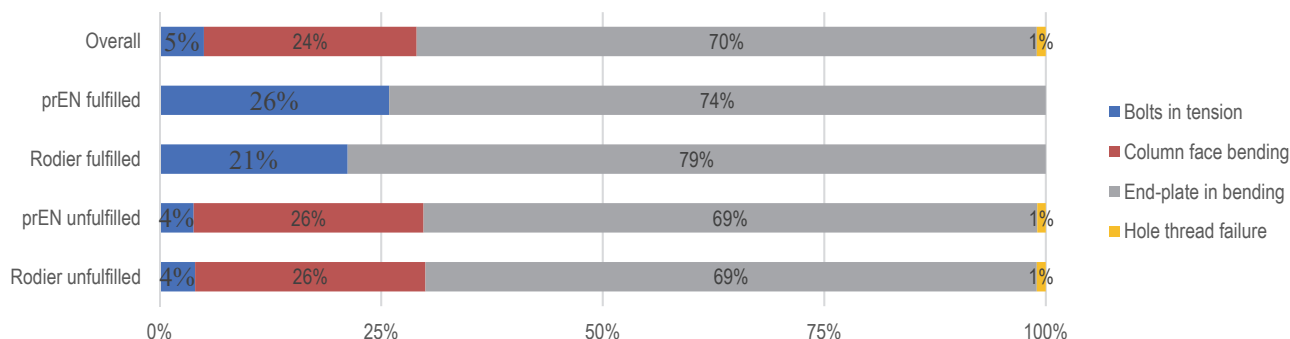

Figure 10 Governing failure mode distributions

Overall results provide a general view of the failure modes relation. However, it is necessary to consider the importance of engagement length, as explained in Section 2. A significant change occurs by applying the minimum thread length conditions, Fig. 11. The conditions defined in prEN 1993-1-8:2020 [25] are met by only 8% of the parameter combinations, while the conditions proposed by Rodier [7] are met by 11% of 3840 considered parameter combinations. These are only cases with column wall thicknesses of 12,5 or 16 mm and M12 or M16 bolts. The distinction between the two thread engagement length requirements is even more pronounced if only 8.8 and 10.9 bolts are considered. In addition to the stricter requirements defined in prEN [25], this difference is also a consequence of limiting all HSS grades to a common value, as shown in Tab. 1.

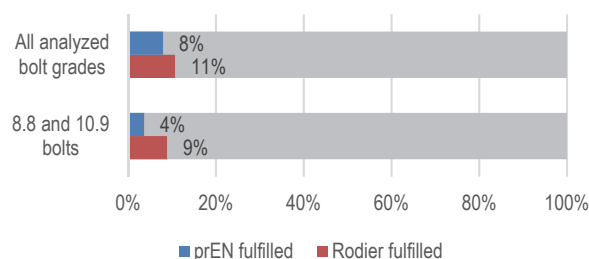

Figure 11 Percentage of combinations fulfilling the minimum thread engagement conditions according to prEN 1993-1-8[25] and Rodier[7]

Nevertheless, by applying the minimum thread engagement length provisions, the problem of thread stripping is solved and only end-plate bending and bolts in tension are the governing failure modes in both cases, Fig.

10. All combinations of parameters with thin and "weak" column walls were eliminated due to the strict thread engagement conditions. For this reason, hole thread failure and column face bending can be avoided. Specific parameters that meet the conditions are discussed in more detail below.

On the other hand, when minimum thread engagement length conditions are not met, the distribution of governing failure modes is very similar to overall results. Again, hole thread failure occurs only in 1% of cases, Fig. 10. To illustrate this, it is necessary to consider the effects of column wall thickness on failure modes. The selected combinations of parameters shown in Fig. 12 do not meet the minimum thread engagement length requirements for all values of column wall thickness $t_{c,w}$. However, the first example shown in Fig. 12a shows that the undesirable hole thread failure mode can be avoided regardless of the

column wall thickness. The envelope of the governing failure modes is generated by end-plate and column face bending, and the same is true for the vast majority of other combinations of parameters considered herein. The second example, Fig. 12b, shows the relationship between column wall thickness and failure modes when the possibility of hole thread stripping failure exists. Hole thread failure turned out to be the governing failure mode on a segment between approximately 10 mm and 13 mm of column wall thickness $t_{c,w}$. The same applies for other cases with hole thread failure as the governing failure mode, and they all combined make only 1% of considered cases. Still, minimum thread engagement requirements are crucial because unfavourable internal and external thread stripping modes are eliminated by applying them. Nonetheless, an insight into additional opportunities for further research on this issue was given.

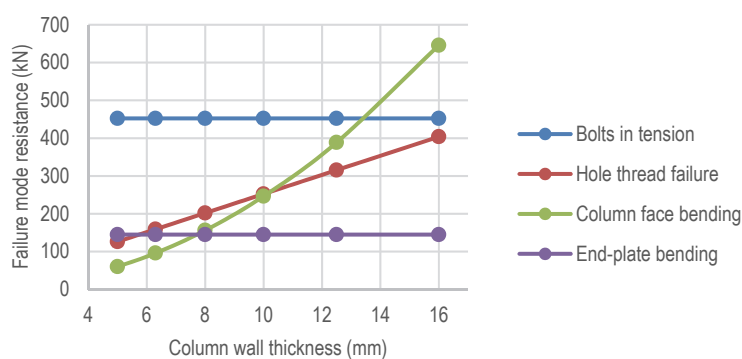

a) Column S355, End-plate S355, $t_p = 10$ mm, Bolts M16, quality grade 10.9

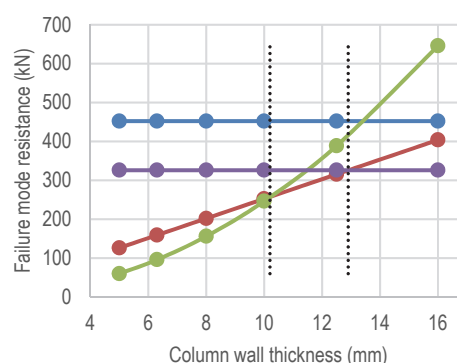

b) Column S355, End-plate S355, $t_p = 15$ mm, Bolts M16, quality grade 10.9

Figure 12 Effects of column wall thickness on governing failure modes

Furthermore, Fig. 13 is showing charts with the number of combinations that meet the minimum thread engagement requirements in relation to specific geometric and mechanical properties of the column and bolts. Evidently, only columns with the highest wall thickness $t_{c,w}$ (12,5 and 16 mm) and bolts of the smallest diameter (M12 and M16) appear on all charts in Fig. 13, meaning that it is not possible to satisfy the thread engagement length conditions by using the remaining parameters. Combining all HSS to a common value according to prEN [25] results with the same number of combinations for all steel grades above and including S460, thus not exploiting the full potential of their mechanical properties, Fig. 13a and Fig. 13c. On the other hand, provisions proposed by Rodier [7] allow the utilization of HSS, and therefore the values increase with column steel grade, Fig. 13b and Fig. 13d. As the minimum thread engagement requirements are defined by two segments the first one derived from bolt thread stripping over-resistance condition and the second one derived from internal thread stripping over-resistance condition so it is reflected in the results. Because the first condition is governing for quality grade bolts 4.6 and 5.6, the same values for every column steel grade were obtained. In other words, this eliminates the risk of external thread stripping. The second condition affects bolts of 8.8 and 10.9 quality grade, the applicability of which improves with the increase of column steel grade, as this reduces the risk of internal thread stripping. Also, when the utilization of HSS is allowed which is the case with Rodier [7]

provisions the possibility of applying larger bolts and column walls of lower thickness increases with higher column steel grades, Fig. 13b and Fig. 13d. Ultimately, it would be convenient to highlight the specific cases that meet the minimum thread engagement requirements together with the corresponding combination of all relevant parameters in order to obtain an overview of the general applicability of BTH to beam-to-tubular column joints. The corresponding values of column wall thickness for each column steel grade, bolt size, and quality grade when the thread engagement requirements are met can be seen in Fig. 14. The results are given only for bolts most commonly used in practice – bolts of quality grade 8.8 and 10.9. Stricter and more conservative criteria according to prEN [25] together with combining all HSS to a common value limit the application of BTH only to columns with wall thickness of 16 mm and M12 bolts. A different approach to thread engagement requirements proposed by Rodier [7] results with a higher possibility of BTH application. It is possible to apply BTH on a column of steel grade S235 with wall thickness of 16 mm and also to apply BTH on columns with wall thickness of 12,5 mm for steel grade S355 and higher. Furthermore, by entering the HSS domain, it is possible to use M16 bolts on columns with wall thickness of 16 mm. This leads to an increase of application possibilities and the ability to design structural steel joints with bolts in threaded holes of higher load-bearing capacity.

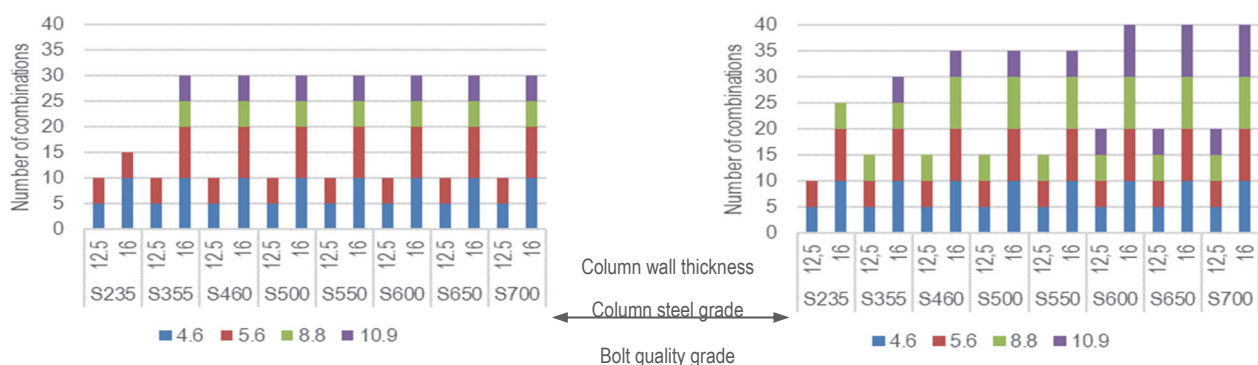

a) prEN [25]-influence of column wall thickness and column steel quality grade for different bolt quality grades b) Rodier [7]-influence of column wall thickness and column steel quality grade for different bolt quality grades

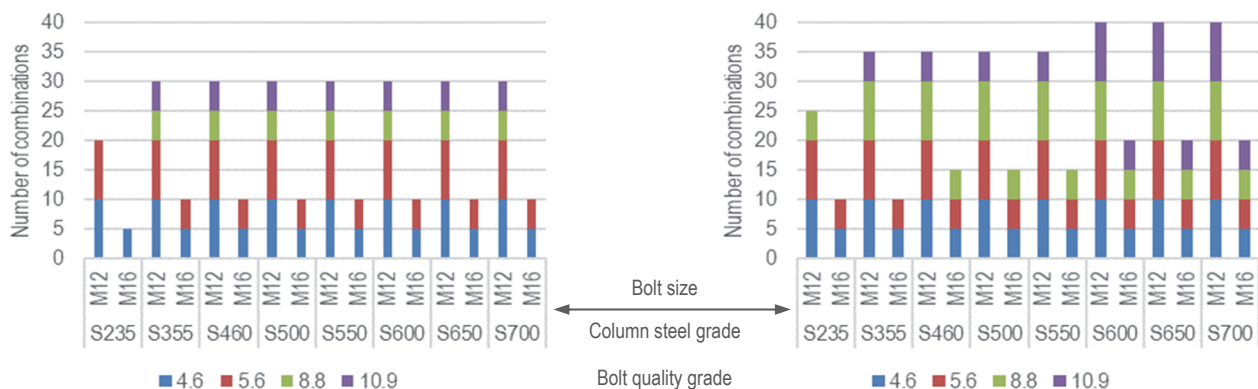

c) prEN [25] influence of bolt size and column steel quality grade for different bolt quality grades d) Rodier [7] influence of bolt size and column steel quality grade for different bolt quality grades

Figure 13 Number of combinations fulfilling the minimum thread engagement conditions according to prEN 1993-1-8 [25] and Rodier [7]

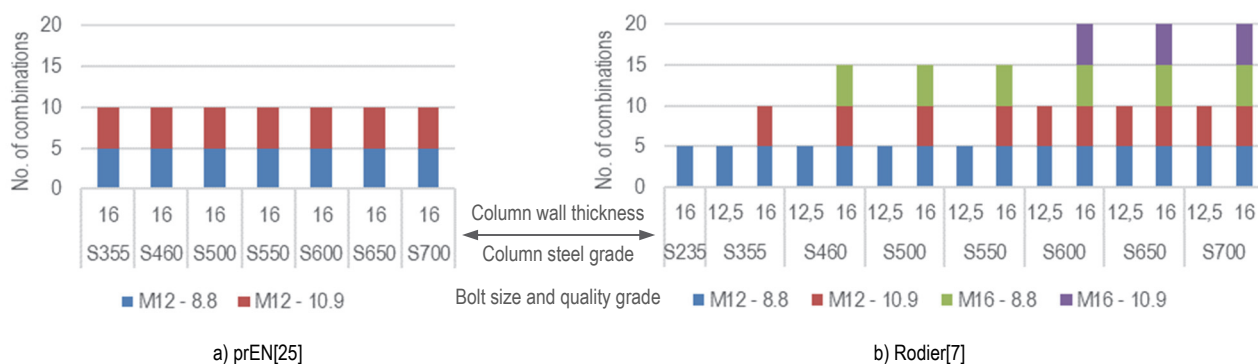

a) prEN[25] b) Rodier[7]
Figure 14 Number of combinations fulfilling the minimum thread engagement condition 8.8 and 10.9 quality grade bolts

5 CONCLUSION

The applicability of bolts in threaded holes in structural steel joints is investigated in this paper. Beam-to-tubular column joint with extended end-plate was analysed, and failure modes were presented in Section 3. The influence of threaded bolts on overall joint resistance was determined using four relevant failure modes: bolts in tension, hole thread failure, column face bending, and end-plate bending. All the considered combinations of parameters were checked for minimum thread engagement length conditions provided by prEN 1993-1-8:2020 [25] and Rodier [7]. These conditions require sufficient thread engagement length to ensure bolt tensile failure by bolt breaking instead of internal or external thread stripping. Bolt breaking is preferable since it is a more ductile and

easily detectable failure mode compared to the hole thread failure.

Main conclusions of this study can be summarized as follows:

- (1) Overall results from parametric study showed that end-plate bending and column face bending make the vast majority of failure modes. Tensile failure of bolts occurs in 5% of considered cases, while threaded holes turned out to be the weakest component in only 1% of cases.
- (2) After applying the minimum thread length requirements, only 8% of considered parameter combinations met the conditions defined in prEN 1993-1-8:2020 [25], while 11% met the conditions proposed by Rodier [7]. This eliminates columns with insufficient wall thickness that can fail by column face bending and hole thread failure.

(3) Analysis of the remaining parameter combinations that do not meet the minimum thread length conditions, hole thread failure turned out again to be the governing failure mode in only 1% of cases, meaning that the undesirable hole thread failure mode can be avoided for the vast majority of considered combinations regardless of the column wall thickness. Nevertheless, applying the minimum thread engagement requirements is necessary to eliminate unfavourable internal and external thread stripping modes.

(4) Parameters in combinations that were able to meet the thread engagement length conditions are only columns with the highest wall thickness (12,5 and 16 mm) and bolts of the smallest diameter (M12 and M16).

(5) Thread engagement provisions from prEN [25] limit the application of BTH only to columns with wall thickness of 16 mm and M12 bolts in case of using quality grade 8.8 and 10.9 bolts. The main limitation is a consequence of combining all high strength steel grades into a single group. As a result, HSS grades are limited to the same minimum thread engagement length values, thus not exploiting the full potential of their mechanical properties.

(6) A different approach proposed by Rodier [7] enables the application of quality grade 8.8 and 10.9 bolts as BTH on columns of steel grade S235 with wall thickness of 16 mm and also on columns with wall thickness of 12,5 mm for steel grade S355 and higher. Besides, it is possible to apply M16 bolts on HSS columns with wall thickness of 16 mm.

(7) Provisions proposed by Rodier [7] allow the utilization of HSS, which means that the possibility of applying larger bolts and column walls of lower thickness increases with higher column steel grades.

(8) Expressions for the minimum thread engagement length derived by Rodier [7] have not been validated by experiments or FEM simulation. Further experimental and FEM investigation regarding this topic is needed to better understand the behaviour and failure mechanisms of BTH and confirm or possibly alleviate the minimum thread engagement limitations.

6 REFERENCES

- [1] Lopes, F., Santiago, A., Simões da Silva, L., Heistermann, T., Veljkovic, M., & Guilherme da Silva, J. (2013). Experimental behaviour of the reverse channel joint component at elevated and ambient temperatures. *International Journal of Steel Structures*, 13, 459-472. <https://doi.org/10.1007/s13296-013-3006-1>
- [2] Heistermann, T., Koltsakis, E., Veljkovic, M., Lopes, F., Santiago, A., & Simões da Silva, L. (2015). Initial stiffness evaluation of reverse channel connections in tension and compression. *Journal of Constructional Steel Research*, 114, 119-128. <https://doi.org/10.1016/j.jcsr.2015.07.006>
- [3] European Committee for Standardization (CEN) (2005). EN1993-1-8. Eurocode 3: Design of steel structures - Part 1-8: Design of joints.
- [4] European Committee for Standardization (CEN) (2005). EN1993-1-8. Eurocode 3: Design of steel structures - Part 1-8: Design of joints; including Corrigendum dated July 2009.
- [5] Javora, A. & Skejić, D. (2017). Resistance assessment of beam-to-column joints with different blind bolt systems. *Technical Gazette*, 24(4), 1103-1112. <https://doi.org/10.17559/TV-20150923165859>
- [6] European Committee for Standardization (CEN) (2018). EN 1090-2:2018. Execution of steel structures and aluminium structures - Part 2: Technical requirements for steel structures (EN 1090-2:2018).
- [7] Rodier, A. (2016). Résistance d'un taraudage à l'arrachement. *Revue Construction Métallique*, (4).
- [8] Zhu, X., Wang, P., Liu, M., Tuoya, W., & Hu, S. (2017). Behaviors of one-side bolted T-stub through thread holes under tension strengthened with backing plate. *Journal of Constructional Steel Research*, 134, 53-65. <https://doi.org/10.1016/j.jcsr.2017.03.010>
- [9] Liu, M., Zhu, X., Wang, P., Tuoya, W., & Hub, S. (2017). Tension strength and design method for thread-fixed one-side bolted T-stub. *Engineering Structures*, 150, 918-933. <https://doi.org/10.1016/j.engstruct.2017.07.093>
- [10] Wulan, T., Wang, P., Li, Y., You, Y., & Tang, F. (2018). Numerical investigation on strength and failure modes of thread-fixed one-side bolted T-stubs under tension. *Engineering Structures*, 169, 15-36. <https://doi.org/10.1016/j.engstruct.2018.05.029>
- [11] Zhang, Y., Liu, M., Ma, Q., Liu, Z., Wang, P., Ma, C., & Sun, L. (2020). Yield line patterns of T-stubs connected by thread-fixed one-side bolts under tension. *Journal of Constructional Steel Research*, 166. <https://doi.org/10.1016/j.jcsr.2020.105932>
- [12] Wulan, T., Ma, Q., Liu, Z., Liu, M., Song, J., Cai, J., & Wang, P. (2020). Experimental study on T-stubs connected by thread-fixed one-side bolts under cyclic load. *Journal of Constructional Steel Research*, 169. <https://doi.org/10.1016/j.jcsr.2020.106050>
- [13] Wang, P., Sun, L., Liu, M., Zhang, B., Hu, X., & Yu, J. (2020). Experimental studies on thread-fixed one-side bolted connection of beam to hollow square steel tube under static bending moment. *Engineering Structures*, 214. <https://doi.org/10.1016/j.engstruct.2020.110655>
- [14] Zhang, Y., Wang, P., Liu, M., Liu, Y., Zhang, B., Zhou, S., & Chen, J. (2020). Numerical studies on yield line patterns of thread-fixed one-side bolted endplate connection to square hollow section column under tension. *Journal of Constructional Steel Research*, 173. <https://doi.org/10.1016/j.jcsr.2020.106262>
- [15] Wang, P., Wulan, T., Liu, M., Qua, H., & You, Y. (2019). Shear behavior of lap connection using one-side bolts. *Engineering Structures*, 186, 64-85. <https://doi.org/10.1016/j.engstruct.2019.02.012>
- [16] Latour, M. & Rizzano, G. (2021). Numerical study on the resistance of thread-fixed one-side bolts: Tensile and bearing strength. *Structures*, 32, 958-972. <https://doi.org/10.1016/j.istruc.2021.03.083>
- [17] Wang, P., You, Y., Liu, M., Zhang, B., Zhou, S., & Chen, J. (2020). Behavior of thread-fixed one-side bolted T-stubs with backing plates at ambient and elevated temperatures. *Journal of Constructional Steel Research*, 170. <https://doi.org/10.1016/j.jcsr.2020.106093>
- [18] You, Y., Liu, M., Liu, Y., Wang, P., Zhou, S., & Chen, J. (2020). Experimental studies on thread-fixed one-side bolted T-stubs in tension at elevated temperatures. *Journal of Constructional Steel Research*, 171. <https://doi.org/10.1016/j.jcsr.2020.106139>
- [19] Alexander, E. M. (1977). Analysis and Design of Threaded Assemblies. *SAE Technical Paper 770420*. <https://doi.org/10.4271/770420>
- [20] Verein Deutscher Ingenieure (VDI) (2015). VDI 2230 Part 1 - Systematic calculation of highly stressed bolted joints - Joints with one cylindrical bolt.
- [21] Skejić, D., Dujmović, D., & Beg, D. (2014). Behaviour of stiffened flange cleat joints. *Journal of Constructional Steel Research*, 103, 61-76. <https://doi.org/10.1016/j.jcsr.2014.07.011>
- [22] International Organization for Standardization (ISO) (2013). ISO 898-1:2013. Mechanical properties of fasteners made of

carbon steel and alloy steel - Part 1: Bolts, screws and studs with specified property classes - Coarse thread and fine pitch thread.

- [23] International Organization for Standardization (ISO) (2012). ISO 898-2:2012. Mechanical properties of fasteners made of carbon steel and alloy steel - Part 2: Nuts with specified property classes - Coarse thread and fine pitch thread.
- [24] European Committee for Standardization (CEN) (2012). EN 1090-1:2012. Execution of steel structures and aluminium structures - Part 1: Requirements for conformity assessment of structural components (EN 1090-1:2009+A1:2011).
- [25] European Committee for Standardization (CEN) (2020). pr EN1993-1-8. Eurocode 3: Design of steel structures - Part 1-8: Design of joints.
- [26] European Committee for Standardization (CEN) (2016). EN 15048-1:2016. Non-preloaded structural bolting assemblies - Part 1: General requirements.
- [27] European Committee for Standardization (CEN) (2016). EN 15048-2:2016. Non-preloaded structural bolting assemblies - Part 2: Fitness for purpose.
- [28] European Committee for Standardization (CEN) (2015). EN 14399-2:2015. High-strength structural bolting assemblies for preloading - Part 2: Suitability for preloading.
- [29] Kurobane, Y., Packer, J., Wardenier, J., & Yeomans, N. (2004). CIDECT Design Guide 9, Design Guide for Structural Hollow Section Column Connections.
- [30] Weynand, K., Busse, E., & Jaspart, J.-P. (2006). First practical implementation of the component method for joints in tubular construction. *Tubular Structures XI*, 139-145. <https://doi.org/10.1201/9780203734964-17>
- [31] Ghobarah, A., Mourad, S., & Korol, R. (1996). Moment-rotation relationship of blind bolted connections for HSS columns. *Journal of Constructional Steel Research*, 40(1), 63-91. [https://doi.org/10.1016/S0143-974X\(96\)00044-2](https://doi.org/10.1016/S0143-974X(96)00044-2)
- [32] Park, A. Y. (2012). *Semi-rigid joints to tubular columns and their use in semi-continuous frame design*. Ph.D. thesis, Faculty of Engineering and Physical Sciences, University of Manchester, Manchester, UK.
- [33] European Committee for Standardization (CEN) (2006). EN 10219-1:2006. Cold formed welded structural hollow sections of non-alloy and fine grain steels - Part 1: Technical delivery conditions.
- [34] European Committee for Standardization (CEN) (2020). EN 10219-3:2020. Cold formed welded steel structural hollow sections - Part 3: Technical delivery conditions for high strength and weather resistant steels.
- [35] International Organization for Standardization (ISO) (1998). ISO 68-1:1998. ISO general purpose screw threads - Basic profile - Part 1: Metric screw threads.

Contact information:

Marko PTIČEK, PhD student
(Corresponding author)
Ivicom Consulting d.o.o.,
Damira Tomljanovića Gavrana 11, 10000 Zagreb, Croatia
E-mail: marko.pticek@ivicom.hr

Davor SKEJIĆ, Associate Professor, PhD
University of Zagreb,
Faculty of Civil Engineering, Department for Structures,
Fra Andrije Kacica-Miosica 26, 10000 Zagreb, Croatia
E-mail: davor.skejic@grad.unizg.hr

Milan VELJKOVIĆ, Full Professor, PhD
Delft University of Technology,
Faculty of Civil Engineering and Geosciences,
Stevinweg 1, 2600 GA Delft, The Netherlands
E-mail: m.veljkovic@tudelft.nl

Gianvittorio RIZZANO, Full Professor, PhD
University of Salerno,
Department of Civil Engineering,
Via Giovanni Paolo II, 132, 84084 Fisciano, Italy
E-mail: g.rizzano@unisa.it