

Projektiranje stambeno poslovne zgrade P+5 i P+10 od CLT-a

Gulam, Marija

Master's thesis / Diplomski rad

2024

Degree Grantor / Ustanova koja je dodijelila akademski / stručni stupanj: **University of Zagreb, Faculty of Civil Engineering / Sveučilište u Zagrebu, Građevinski fakultet**

Permanent link / Trajna poveznica: <https://um.nsk.hr/um:nbn:hr:237:019630>

Rights / Prava: [In copyright](#)/[Zaštićeno autorskim pravom.](#)

Download date / Datum preuzimanja: **2025-03-14**

Repository / Repozitorij:

[Repository of the Faculty of Civil Engineering,
University of Zagreb](#)



Gulam_Marija_Diplomski_rad.p df

by Marija Gulam

Submission date: 12-Sep-2024 12:23PM (UTC+0200)

Submission ID: 1656341070

File name: Gulam_Marija_Diplomski_rad.pdf (40.82M)

Word count: 1629

Character count: 4532



Sveučilište u Zagrebu

GRAĐEVINSKI FAKULTET

Marija Gulam

**PROJEKTIRANJE STAMBENO POSLOVNE
ZGRADE P+5 I P+10 OD CLT-A**

DIPLOMSKI RAD

Zagreb, 2024.



Sveučilište u Zagrebu

GRAĐEVINSKI FAKULTET

Marija Gulam

**PROJEKTIRANJE STAMBENO POSLOVNE
ZGRADE P+5 I P+10 OD CLT-A**

DIPLOMSKI RAD

Mentor: prof. dr. sc. Vlatka Rajčić

Komentor: dr. sc. Nikola Perković

Zagreb, 2024.



University of Zagreb

FACULTY OF CIVIL ENGINEERING

Marija Gulam

**DESIGN OF THE RESIDENT – OFFICE
BUILDING FORM CLT – P+5 AND P+10**

MASTER THESIS

Supervisor: prof. dr. sc. Vlatka Rajčić

Co-supervisor: dr. sc. Nikola Perković

Zagreb, 2024.

ZAHVALE

SAŽETAK

Tema ovog rada je projekt stambeno poslovnog kompleksa koji se sastoji od dva objekta katnosti P+10 (zgrada A) i P+5 (zgrada B) od križno lameliranog drva sa zajedničkom garažom. Konstrukcija je proračunata na granično stanje nosivosti, granično stanje nosivosti u slučaju požara te na granično stanje uporabivosti. Pri proračunu konstrukcije korišteni su software-i *Dlubal RFEM i Calculatis*. Osim projektnog zadatka, dan je i uvid u korištene materijale, križno lamelirano drvo i lijepljeno lamelirano drvo, te prednosti gradnje drvenih konstrukcija. Projekt je u skladu sa skupom europskih normi Eurocode.

Ključne riječi: križno lamelirano drvo, projektiraje drvene konstrukcije, održiva gradnja, prirodni materijali

SUMMARY

The subject of this paper is the design of the resident – office building complex consisting of two buildings P+10 (Building A) and P+5 (Building B), made of cross-laminated timber, with a shared garage. The structural analysis was conducted for the ultimate limit state, the ultimate limit state in case of fire, and the serviceability limit state. The software tools Dlubal RFEM and Calculatis were used for design and structural calculations. In addition to the project, the paper also presents an overview of the materials used, cross laminated timber and glue laminated timber, along with the benefits of timber construction. The project complies with the set of European standards Eurocode.

Key words: Cross Laminated Timber, timber structures design, sustainable construction, natural materials

SADRŽAJ

ZAHVALE.....	i
SAŽETAK.....	ii
SUMMARY.....	iii
SADRŽAJ.....	iv
1 UVOD.....	1
2 PROJEKTNI ZADATAK.....	9
2.1 Idejno arhitektonsko rješenje.....	9
2.2 Tehnički opis.....	11
2.3 Analiza opterećenja.....	13
2.3.1 Vlastita težina nosivih i ne nosivih dijelova konstrukcije.....	13
2.3.2 Uporabno opterećenje.....	13
2.3.3 Opterećenje snijegom.....	13
2.3.4 Opterećenje vjetrom.....	14
2.3.5 Potresno opterećenje.....	24
2.4 Statički proračun.....	25
2.4.1 Proračun zgrade A (P+10).....	25
2.4.2 Proračun zgrade B (P+5).....	63
2.5 Dimenzioniranje nosivih dijelova konstrukcije.....	96
2.5.1 Krovna ploča.....	97
2.5.2 Međukatna konstrukcija.....	125
2.5.3 Čelična greda.....	149
2.5.4 Zid s otvorom.....	156
2.5.5 Stupovi.....	165
2.6 Dimenzioniranje karakterističnih spojeva.....	171
2.6.1 Spoj CLT zida s betonskom pločom.....	171
2.6.2 Spoj CLT zidova.....	178
2.6.3 Spoj CLT zida s CLT pločom.....	183
2.6.4 Spoj zid – ploča – zid.....	187
2.6.5 Nastavak ploče.....	191
2.6.6 Spoj CLT ploče i čelične grede.....	196
2.7 Iskaz materijala.....	201
3 ZAKLJUČAK.....	208

POPIS LITERATURE	209
POPIS SLIKA.....	210
POPIS TABLICA.....	212
PRILOZI	213

1 UVOD

Drvo je jedan od najstarijih i najčešće korištenih materijala u graditeljstvu. Tradicionalne drvene konstrukcije izvodile su se kao lagani okvirni sustavi s linijskim elementima od punog drva i ograničenih raspona. U 20. stoljeću drvo je zamijenjeno čelikom i betonom zbog ekonomičnosti i mogućnosti gradnje visokih zgrada.

Zanimanje za drvene konstrukcije ponovno je poraslo u drugoj polovici 20. stoljeća s razvojem novih tehnologija i materijala na bazi drva. Prvi pločasti proizvodi, kao što su LVL i OSB, koristili su se kao sekundarni elementi. Lijepljeno lamelirano drvo (LLD) i križno lamelirano drvo (eng. *Cross Laminated Timber* – CLT) omogućili su gradnju viših, kompleksnijih objekata, što je otvorilo vrata za primjenu drva u suvremenom graditeljstvu.

Križno lamelirano drvo (CLT) relativno je novi pločasti proizvod na bazi drva. Patentiran u Europi u 90-ima, vrlo brzo se našao u primjeni i van granica Europe zbog svojih seizmičkih i požarnih svojstava. Zemlje poput SAD, Kanade, Japana i Kine sve češće koriste proizvode od CLT-a.

CLT predstavlja kruti pločasti proizvod sastavljen od odgovarajućeg broja slojeva (uglavnom neparnog 3, 5 ili 7), gdje je svaki sloj načinjen od lamela položenih jedna do druge pri čemu su susjedni slojevi lijepljeni okomito jedan na drugi. [1]

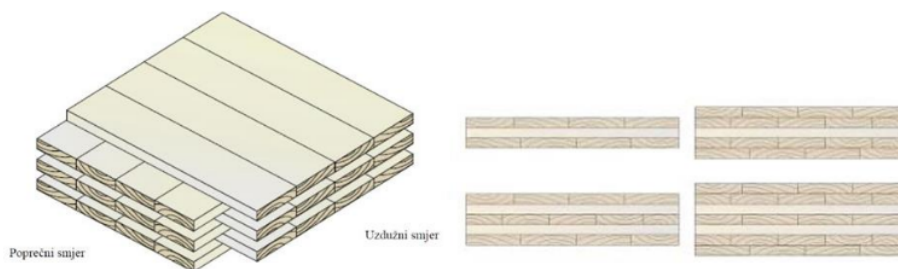

Slika 1. Slaganje lamela unutar jednog panela

Uslojena struktura omogućuje nosivost u ravnini i okomito na ravninu elementa s primjenom u obliku zidnih nosača i stropnih ploča. Mala gustoća drva ($400\text{--}500\text{ kg/m}^3$) čini proizvod relativno lagan, a paneli postižu jako dobre karakteristike čvrstoće i krutosti. Mala vlastita težina olakšava temeljenje i omogućuje primjenu u seizmički aktivnim područjima. S obzirom da se radi o predgotovljenim elementima, CLT se odlikuje i brzinom montaže.

Zbog svojih prednosti, CLT je sve popularniji u visokogradnji i mostogradnji te u zemljama izloženim potresima.

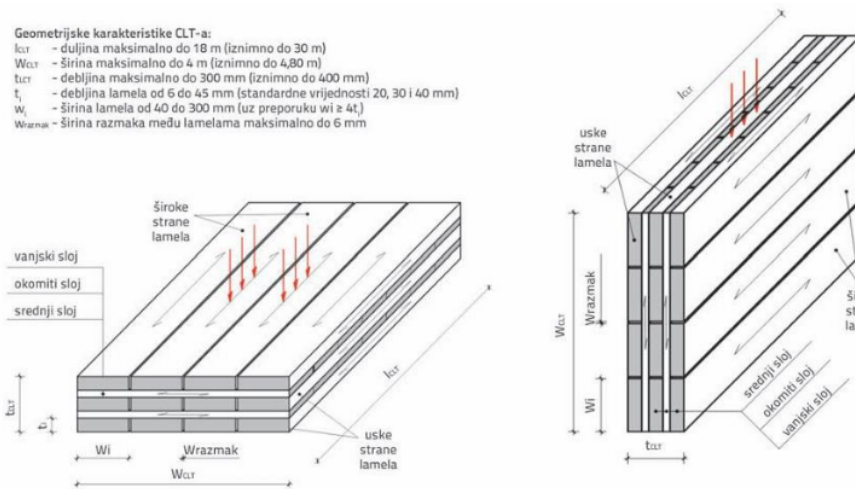

Slika 2. Geometrijske karakteristike CLT elemenata za djelovanje okomito na ravninu (lijevo) i djelovanje u ravnini (desno)

Širina jednog panela obično iznosi do 4 metra uz mogućnost postizanja i većih širina (do 4,8 m), dok u duljinu paneli idu do 18 metara, iznimno i više. Debljina pojedine lamele kreće se u rasponu 16-51 mm, a širine su 60-240 mm.

Za proizvodnju panela najčešće se koristi meko drvo, klase C24. Dopušteno je kombiniranje sa slabijim klasama drva, C16/C18, u okomitim slojevima, iako nije uobičajeno.

Postupak proizvodnje panela možemo podijeliti na dva osnovna dijela; priprema i obrada osnovnog materijala te slaganje i lijepljenje osnovnog materijala. Postupak započinje sušenjem i klasifikacijom lamela. Pojava pukotina se sprječava održavanjem vlage u granicama 9%-15%. Slijedi slaganje i lijepljenje lamela jednodirektnim poliuretanskim ljepilom (1K-PUR) ili melanim-urea-fomaldehidom (MUF). Nakon lijepljenja paneli su izloženi hidrauličkom pritisku ili pritisku u vakuumu. U zadnjem koraku proizvodnje korigira se geometrija panela te se paneli režu na zahtijevane dimenzije, za što se danas koriste CNC strojevi. Završna obrada panela ovisi o potrebama i mjestu gdje se panel ugrađuje. Na slici 3. prikazan je postupak proizvodnje CLT panela.

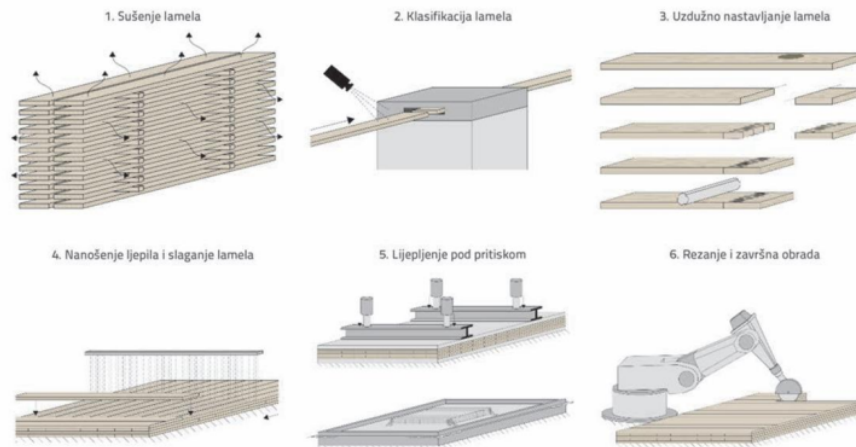

Slika 3. Postupak proizvodnje CLT panela

U europskoj normi za CLT, EN 16351, reguliraju se ograničenja vezana za proizvodnju i izvedbu CLT panela (zahtjevi za ljepila, kontrola proizvodnje/kvalitete), ali još uvijek nisu dani jedinstveni postupci proračuna istih. Postupke proračuna moguće je pronaći u raznim tehničkim propisima i specifikacijama izdanim od strane proizvođača. Također, postoje i priručnici i smjernice pojedinih nacionalnih tijela koji daju preporuke za projektiranje zgrada.

Još jedna prednost CLT-a su njegove toplinske karakteristike. Ima izvrsna izolacijska svojstva, što znači da može pomoći u održavanju zgrada toplima zimi i hladnima ljeti. To može dovesti do značajnih energetske uštede.

Dok drveće raste, ono upija ugljikov dioksid (dalje CO_2) i skladišti ga. Iako se CO_2 emitira tijekom obrade drva, proizvodnja betona mnogo je intenzivnija po pitanju emisija. Na primjer, samo u proizvodnji jedne tone cementa emitira se oko pola tone CO_2 . [4] Razne studije pokazale su da CLT može smanjiti emisije CO_2 kod velikih zgrada za 40% u odnosu na druge građevinske materijale. [3] Pregled emisija zgrada od različitog materijala možemo vidjeti na slici 4.

Drvo može biti ponovno upotrebjeno i nakon rušenja zgrada, primjerice za proizvodnju namještaja. Ako drvo dolazi iz održivih šuma, gdje se stabla zamjenjuju nakon sječe, te se reciklira nakon životnog vijeka konstrukcije, CLT može biti moćno rješenje za smanjenje emisija i borbu protiv klimatskih promjena.



Slika 4. Pregled emisije ugljikovog dioksida za zgrade od različitih materijala

U zadnjih 15-ak godina u svijetu je izgrađeno na desetke višetažnih drvenih zgrada te hibridnih sustava drvo – beton i drvo – čelik u kojima drvo tvori okvire i međukatne konstrukcije, a beton i čelik čine jezgru.

Kada je riječ o gradnji drvom, postoje dva načina gradnje – lagana i masivna gradnja. Lagana gradnja izvodi se okvirnim sustavima s linijskim elementima, dok se masivna gradnja izvodi s pločastim elementima. Dva popularna izbora materijala čine križno lamelirano drvo (CLT) i lijepljeno lamelirano drvo (LLD).

Mogućnosti uporabe ploča od CLT-a u stambenoj gradnji odlikuje raznolikost proizvoda i konstrukcijskih elemenata. Primjenjuju se u izvedbi konstrukcija stropova, vanjskih i unutarnjih zidova i pokrovnih elemenata velikih dimenzija, ali i za konstrukcije ploča stubišta i balkona, te kao nosivi elementi plošnog tipa za nadvoje i stupove. Za raspone veće od 6 m i više zidne elemente bez dodatnih potpora preporučuju se ploče s rebrastim ojačanjima od lijepljenih lameliranih greda. Prikaz načina gradnje s CLT panelima prikazan je na slici 5.

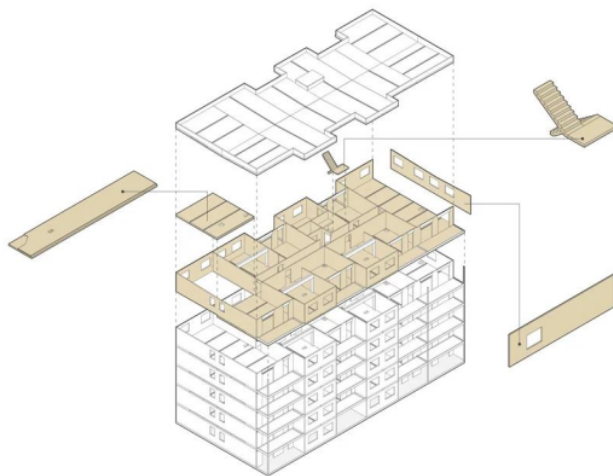

Slika 5. Shematski prikaz gradnje s CLT panelima

Međusobno spajanje ploča od CLT-a u karakterističnim spojevima i prijenos opterećenja uglavnom se odvija točkasto, npr. vijcima za drvo, ulijepljenim navojnim šipkama, čavlima, trnovima, vijcima i drugim mehaničkim spajalima .

Za razliku od CLT-a, LLD ima slojeve orijentirane u jednom smjeru te primarno nosi u jednoj ravnini. Kao takav pogodan je za linijske elemente, odnosno grede i stupove za koje nije bitna nosivost van glavne ravnine elementa. LLD se najčešće koristi pri svladavanju velikih raspona kao što su krovne konstrukcije različitih oblika, okvirne konstrukcije hala i mostovi.

Prednost okvirne gradnje s linijskim elementima je mogućnost ostvarivanja velikih otvorenih planova u dizajnu, primjerice uredi i komercijalne zgrade. LLD je jeftiniji od CLT-a jer je utrošak materijala manji. Prikaz načina gradnje s LLD gredama i stupovima prikazan je na slici 6.

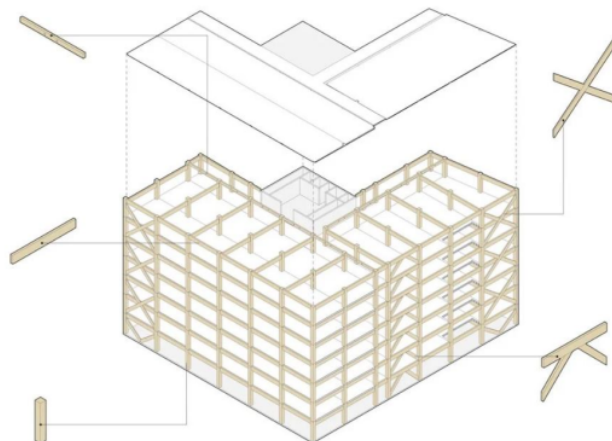

Slika 6. Shematski prikaz gradnje sa LLD stupovima i gredama

Često se izvode građevine koje kombiniraju oba sustava gradnje, maksimalno koristeći sve njihove prednosti, gdje se LLD koristi za mrežu stupova i greda, a CLT se koristi za međukatne konstrukcije i zidove.

U zadnjih 15-ak godina u svijetu je izgrađeno na desetke višetažnih drvenih zgrada te hibridnih sustava drvo – beton i drvo – čelik u kojima drvo tvori okvire i međukatne konstrukcije, a beton i čelik čine jezgru.

Jedna od najznačajnijih visokih zgrada od drva je Mjøstårnet u Norveškoj (Slika 7.), zgrada sa 18 etaža, izgrađena koristeći CLT, LLD i LVL, a na sedam najviših etaža korištene su betonske ploče kako bi se povećala težina i smanjio utjecaj horizontalnih djelovanja.

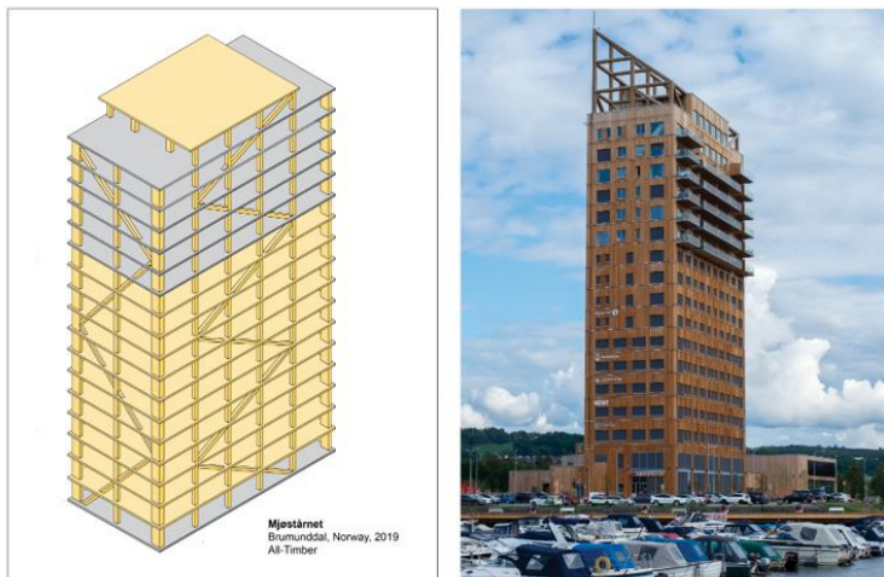

Slika 7. Mjøstårnet, Norveška

Još jedan primjer je i zgrada Brock Commons Tallwood House u Kanadi (Slika 8.), također sa 18 etaža, izgrađena je za manje od 70 dana. Nosivu konstrukciju čine LLD stupovi sa CLT pločama, prizemlje i dvije jezgre su betonske, a krovna konstrukcija je od čeličnih greda.

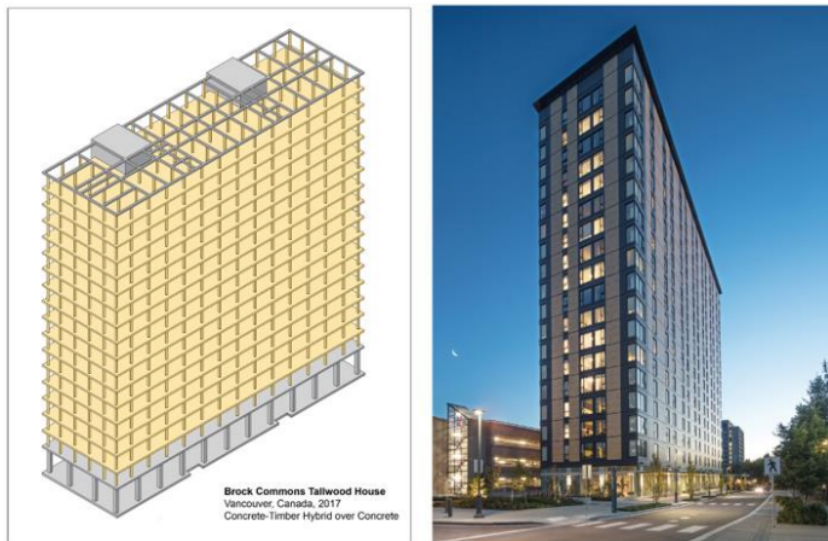

Slika 8. Brock Commons Tallwood House, Vancouver, Kanada

Zgrada Ascent, SAD, visine 86,6 metara, najviša je zgrada od drva u svijetu (Slika 9.). Sastoji se od 25 etaža, od čega su dvije jezgre i prvih 5 etaža izvedene od armiranog betona, a ostalih 18 etaža izvedene su u kombinaciji CLT-a i LLD-a.



Slika 9. Ascent, SAD

CLT ima i veliku primjenu u nadogradnji postojećih objekata zbog lakog spajanja s drugim materijalima, poput čelika, betona i stakla. Jedan takav primjer nadogradnje je zgrada *55 Southbank Boulevard u Melbourne-u* (Slika 10.) gdje je, na već postojeću betonsku zgradu, bila predviđena nadogradnja 5 katova u betonu, ali korištenjem CLT-a, čija je težina pet puta manja od težine betona, nadograđeno je ukupno 10 dodatnih katova.



Slika 10. 55 Southbank Boulevard, Melbourne, Australia

2 PROJEKTNI ZADATAK

2.1 Idejno arhitektonsko rješenje

Podloga ovog diplomskog rada bio je projektni zadatak u sklopu studentskog natjecanja *proHolz Student Trophy 24*, čija je tema bila istraživanje mogućnosti širenja i jačanja urbanih središta korištenjem drva kao građevinskog materijala. Urbana područja proširivala su se i nadograđivala u interakciji s već izgrađenim objektima.

Zadaci su bili podijeljeni na tri građevinske lokacije u Beču te su uključivali proširenje školske zgrade, dodatak uz rub bloka te vertikalnu nadogradnju postojeće zgrade. (Slika 11.)



Slika 11. Situacija

Natjecanje je zamišljeno kao suradnja studenata građevinskog i arhitektonskog fakulteta. Zajedno s kolegama odlučili smo da će naš projekt biti dodatak uz rub bloka. (Slika 12)

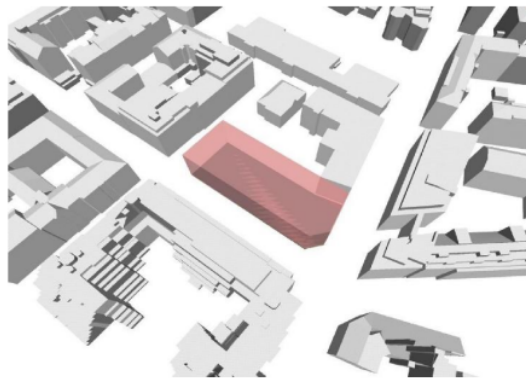

Slika 12. Mikrolokacija postojećeg bloka

Koncept projekta temelji se na prilagodbi parceli na sjeverozapadnom rubu bloka. Dvije zgrade u obliku slova „L” omogućuju prolaz i stvaraju zelenu, aktivnu okolinu namijenjenu javnoj upotrebi. Idejni prikaz projekta prikazan je na slikama 13.-15.



Slika 13. Pogled na zgradu - sjeverozapad Slika 14. Pogled na zgradu - sjeveroistok



Slika 15. Pogled na zgradu - sjeveroistok

2.2 Tehnički opis

Ovim radom predviđen je projekt drvene nosive konstrukcije stambeno poslovnog kompleksa od križno lameliranog drva (dalje CLT) i lijepljenog lameliranog drva (dalje LLD) u Zagrebu. Kompleks se sastoji od dvije zgrade katnosti P+10 (zgrada A) i P+5 (zgrada B) sa zajedničkom garažom. Zgrada se jednim zidom naslanja na već postojeću građevinu unutar bloka.

Armiranobetonska konstrukcija (dalje AB), koja obuhvaća garažu, jezgru stubišta i dizala te temeljnu ploču, bit će obrađena kroz pretpostavljene dimenzije, ali se neće detaljno proračunavati.

Konstrukcija zgrade A je nepravilnog oblika, tlocrtnih dimenzija 40x13,3 m na etažama P do 4. kata, tlocrtna dimenzija etaža od 5. do 10. kata su 18,4x13,3 m sa zaobljenim rubovima $\Phi 1,5$ m. Na etaži 5. kata nalazi se krovna terasa, a na posljednjoj etaži je neprohodan krov. Ukupna visina je 33,3 m.

Konstrukcija zgrade B je pravilnog oblika, tlocrtnih dimenzija 13,3x27,14 m. Ukupna visina objekta je 18,3 m. Na posljednjoj etaži nalazi se krovna terasa.

Temelji ispod garaže izvedeni su kao trake širine 80 i dubine 100 cm ispod zidova, dok se ispod stupova nalaze temeljne stope dimenzija 2,0x2,0 m i dubine 1,0 m. Preko njih je položena AB temeljna ploča debljine 30 cm. Temeljno tlo je kruta glina i spada u tip C temeljnog tla.

Garaža te jezgra stubišta i dizala izvedene su od AB klase C35/45, dok su svi ostali elementi izvedeni od LLD-a i CLT-a. Kvaliteta CLT-a je C24, dok je kvaliteta LLD-a GL32h. Garaža je u potpunosti ukopana, a sastoji se od AB zidova debljine 30 cm i stupova dimenzija 25x25 cm na koje su povezane AB grede dimenzija b/h=30/30 cm. Visina garaže je 3 m, strop garaže izveden je kao AB ploča debljine 25 cm na koju se spajaju elementi od CLT-a i LLD-a. Etaže od prizemlja do 10. kata izvedene su kombinacijom LLD stupova, zidnih i stropnih panela od CLT-a te čeličnih greda kvalitete S355. Visina prizemlja je 3,3 m, dok je visina ostalih etaža 3 m.

CLT paneli koji će se koristiti u izvedbi su od proizvođača *Stora Enso*. Paneli za izvedbu zidnih elemenata su CLT 140 L5s (debljina 140 mm, sastoji se od 5 slojeva lamela, od kojih su 3 u dominantom smjeru opterećenja). Paneli za izvedbu međukatnih konstrukcija ovise o statičkom sustavu, za kontinuirano oslonjene panele korišten je CLT 200 L5s (debljina 200 mm, sastoji se od 5 slojeva lamela), dok se za ploče na velikim rasponima koristi CLT 160 L5s (debljina 160 mm, sastoji se od 5 slojeva lamela) sa čeličnom gredom na sredini raspona

HE 280 A. Klasa drva korištena za lamele u panelima je C24. Stupovi od LLD-a su dimenzija 200x200 mm.

Požarna otpornost vertikalnih elemenata (zidova) je R90, dok su horizontalni elementi (međukatne i krovne ploče) R60.

Paneli te stupovi i grede spajaju se spojnim sredstvima proizvođača Rothoblaas. Korišteni su kutnici za spojeve zidova s pločama, dok su kod spoja ploča korišteni vijci pod kutom 45°.

Projektom su predviđene sve standardne instalacije koje podrazumijeva stambeni objekt (vodovod i kanalizacija, električne instalacije, klimatizacija, protupožarne instalacije, cijevi itd.). Konstrukcija je projektirana tako da zadovolji granična stanja nosivosti i uporabivosti te požarnu otpornost i vibracije. U statički proračun uzeta su sva opterećenja koja propisuje Eurocode s pripadajućim nacionalnim dodacima. Provedena je i dinamička (potresna) analiza te je dokazana otpornost konstrukcije na vršno ubrzanje tla vjerojatnosti premašaja od 10% u 50 godina (povratni period od 475 godina).

Prilikom proračuna su primijenjene sljedeće norme iz pojedinih Eurokodova: HRN EN 1990, HRN EN 1991, HRN EN 1993, HRN EN 1995 i HRN EN 1998 te pripadajući nacionalni dodaci za RH i Sloveniju. Za potrebe cjelokupnog proračuna korišteni su programi *Dlubal RFEM 6* te *Calculatis – Stora Enso*.

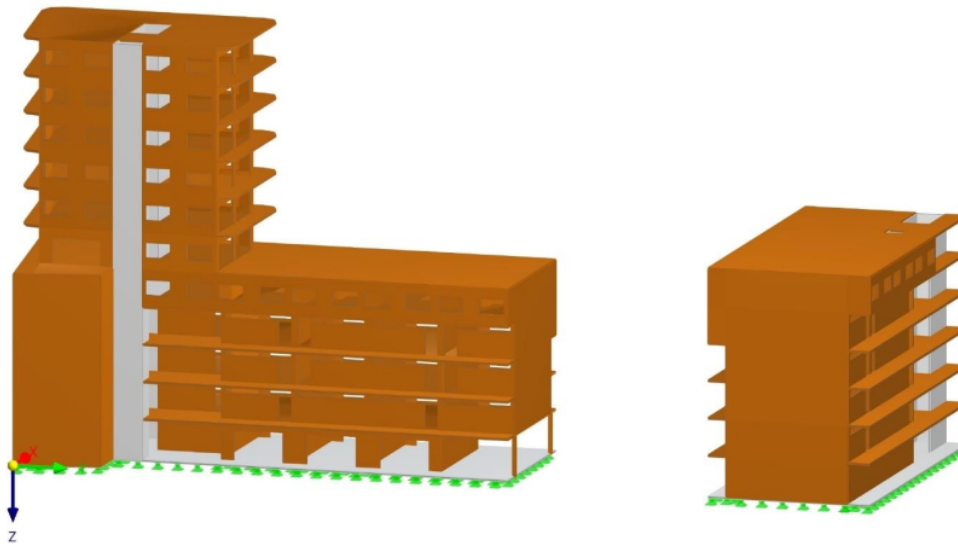

Slika 16. Prikaz modela zgrade – Dlubal RFEM

2.3 Analiza opterećenja

2.3.1 Vlastita težina nosivih i ne nosivih dijelova konstrukcije

Vlastita težina svih nosivih elemenata uzima se u programskom paketu Dlubal RFEM njegovim automatskim proračunom.

Dodatno stalno opterećenje od ne nosivih dijelova konstrukcije iznosi ¹ $1,5 \text{ kN/m}^2$.

2.3.2 Uporabno opterećenje

Prema HRN EN 1991-1-1:2012 i HRN EN 1991-1-1:2012/NA:2012 uporabno opterećenje iznosi:

- stropovi $q_k = 2,0 \text{ kN/m}^2$
- balkoni $q_k = 2,5 \text{ kN/m}^2$
- krovne terase $q_k = 4,0 \text{ kN/m}^2$
- neprohodan krov $q_k = 0,6 \text{ kN/m}^2$

2.3.3 Opterećenje snijegom



Slika 17. Karakteristična vrijednost opterećenja snijegom na tlo za lokaciju Zagreb

Prema HRN EN 1991-1-3:2012 i HRN EN 1991-1-3:2012/NA:2012 opterećenje snijegom na krovu dobiva se prema izrazu:

$$s = \mu_i \cdot C_e \cdot C_t \cdot s_k$$

- građevina se nalazi u Zagrebu (158 m n.m.) ; područje 3 – $s_k = 1,25 \text{ kN/m}^2$
- koeficijent izloženosti $C_e = 1,0$; preporučena vrijednost prema HRN EN 1991-1-3:2012/NA
- toplinski koeficijent zbog zagrijavanja građevine $C_t = 1,0$; preporučena vrijednost prema HRN EN 1991-1-3:2012/NA
- koeficijent oblika opterećenja snijegom na krovu μ_i ovisi o nagibu i tipu krova, te ovisi o mogućnosti klizanja snijega s krova; za ovaj slučaj iznosi $\mu_i = 0,8$

Opterećenje snijegom na krovu iznosi:

$$s = 0,8 \cdot 1,0 \cdot 1,0 \cdot 1,25 = 1,0 \text{ kN/m}^2$$

2.3.4 Opterećenje vjetrom



Slika 18. Osnovna brzina vjetra za lokaciju Zagreb

Prema HRN EN 1991-1-4:2012 i HRN EN 1991-1-4:2012/NA:2012 osnovna brzina vjetra dobiva se prema izrazu:

$$v_b = c_{dir} \cdot c_{season} \cdot v_{b,0}$$

- temeljna vrijednost osnovne brzine vjetra $v_{b,0} = 20 \text{ m/s}$

- kategorija terena: IV
- referentna visina zgrade A: $(z_{e,A}) = 33,3 \text{ m}$
- koeficijent izloženosti krovne plohe zgrade A: $c_e(z_{e,A}) = 2,02$ – očitano iz dijagrama
- referentna visina zgrade B: $(z_{e,B}) = 18,3 \text{ m}$
- koeficijent izloženosti krovne plohe zgrade B: $c_e(z_{e,B}) = 1,57$ – očitano iz dijagrama
- faktor smjera vjetra $c_{dir} = 1,0$; preporučena vrijednost prema HRN EN 1991-1-4:2012/NA
- faktor godišnjeg doba $c_{season} = 1,0$; preporučena vrijednost prema HRN EN 1991-1-4:2012/NA

$$v_b = 1,0 \cdot 1,0 \cdot 20 = 20 \text{ m/s}$$

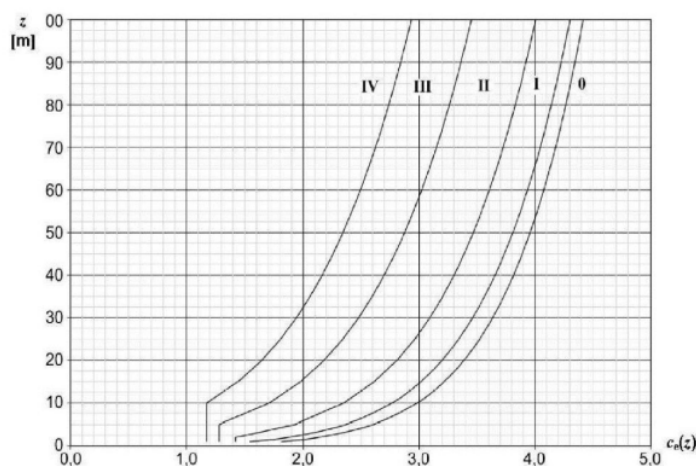

Slika 19. Koeficijent izloženosti

Tlak pri osnovnoj brzini vjetra određuje se prema izrazu:

$$q_b = 0,5 \cdot \rho \cdot v_b^2$$

- gustoća zraka $\rho = 1,25 \text{ kg/m}^3$

$$q_b = 0,5 \cdot 1,25 \cdot 20^2 = 250 \text{ N/m}^2 = 0,25 \text{ kN/m}^2$$

Tlak pri vršnoj brzini na referentnoj visini z_e iznosi

- za zgradu A:

$$q_p(z_{e,A}) = c_e(z_{e,A}) \cdot q_b = 2,02 \cdot 0,25 = 0,505 \text{ kN/m}^2$$

- za zgradu B:

$$q_p(z_{e,B}) = c_e(z_{e,B}) \cdot q_b = 1,57 \cdot 0,25 = 0,393 \text{ kN/m}^2$$

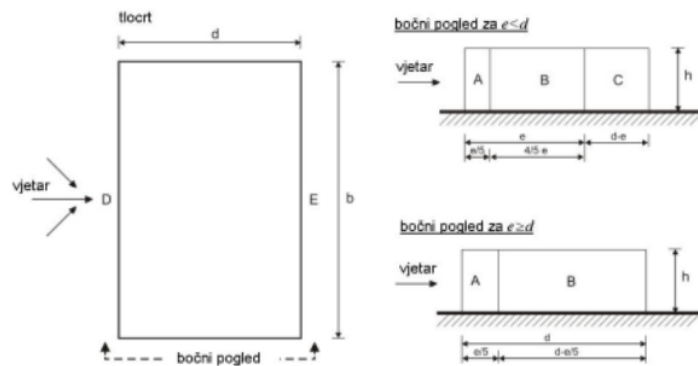

Slika 20. Koeficijenti vanjskog tlaka za vertikalne zidove građevina pravokutnog tlocrta

Vrijednosti koeficijenata vanjskog tlaka za vertikalne zidove:

- Područje A: $c_{pe,10,A} = -1,2$
- Područje B: $c_{pe,10,B} = -0,8$
- Područje C: $c_{pe,10,C} = -0,5$
- Područje D: $c_{pe,10,D} = +0,8$
- Područje E: $c_{pe,10,E} = -0,5$

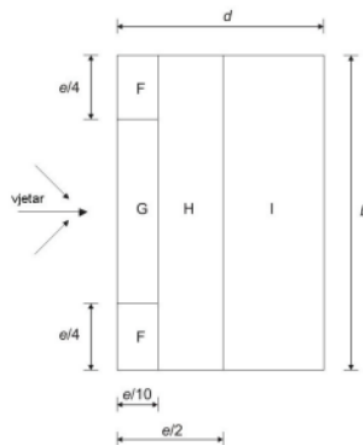

Slika 21. Koeficijenti vanjskog tlaka za ravne krovove

Vrijednosti koeficijenata vanjskog tlaka za ravne krovove $-5^\circ < \alpha < 5^\circ$:

- Područje F: $c_{pe,10,F} = -1,8$
- Područje G: $c_{pe,10,G} = -1,2$

- Područje H: $c_{pe,10,H} = -0,7$
- Područje I: $c_{pe,10,I,min} = -0,2$
 $c_{pe,10,I,max} = +0,2$

Vrijednosti koeficijenta unutarnjeg tlaka:

- $c_{pi,min} = -0,3$
- $c_{pi,max} = +0,2$

Ukupni tlak vjetra određuje se kao zbroj unutarnjeg i vanjskog tlaka:

$$w = w_e + w_i$$

2.3.4.1 Određivanje ukupnog tlaka vjetra po površinama za zgradu A

Iznosi vanjskog tlaka po površini bočnih ploha:

$$w_{e,A} = q_p(z_{e,A}) \cdot c_{pe,10,A} = 0,505 \cdot (-1,2) = -0,61 \text{ kN/m}^2$$

$$w_{e,B} = q_p(z_{e,A}) \cdot c_{pe,10,B} = 0,505 \cdot (-0,8) = -0,40 \text{ kN/m}^2$$

$$w_{e,C} = q_p(z_{e,A}) \cdot c_{pe,10,C} = 0,505 \cdot (-0,5) = -0,25 \text{ kN/m}^2$$

$$w_{e,D} = q_p(z_{e,A}) \cdot c_{pe,10,D} = 0,505 \cdot (+0,8) = +0,40 \text{ kN/m}^2$$

$$w_{e,E} = q_p(z_{e,A}) \cdot c_{pe,10,E} = 0,505 \cdot (-0,5) = -0,25 \text{ kN/m}^2$$

Iznosi vanjskog tlaka po površini krova:

$$w_{e,F} = q_p(z_{e,A}) \cdot c_{pe,10,F} = 0,505 \cdot (-1,8) = -0,91 \text{ kN/m}^2$$

$$w_{e,G} = q_p(z_{e,A}) \cdot c_{pe,10,G} = 0,505 \cdot (-1,2) = -0,61 \text{ kN/m}^2$$

$$w_{e,H} = q_p(z_{e,A}) \cdot c_{pe,10,H} = 0,505 \cdot (-0,7) = -0,35 \text{ kN/m}^2$$

$$w_{e,I,min} = q_p(z_{e,A}) \cdot c_{pe,10,I,min} = 0,505 \cdot (-0,2) = -0,10 \text{ kN/m}^2$$

$$w_{e,I,max} = q_p(z_{e,A}) \cdot c_{pe,10,I,max} = 0,505 \cdot (+0,2) = +0,10 \text{ kN/m}^2$$

Iznosi unutarnjeg tlaka za sve površine:

$$w_{i,max} = q_p(z_{i,A}) \cdot c_{pi,max} = 0,505 \cdot (+0,2) = +0,10 \text{ kN/m}^2$$

$$w_{i,min} = q_p(z_{i,A}) \cdot c_{pi,min} = 0,505 \cdot (-0,3) = -0,15 \text{ kN/m}^2$$

2.3.4.2 Slučaj 1 – vjetar puše u smjeru 0° (180°), $c_{pi} = +0,2$

$$h = 33,3 \text{ m}$$

$$e = \min(b; 2h) = \min(18,2; 66,6) = 18,2$$

$$d = 41,7 \text{ m} \rightarrow e < d$$

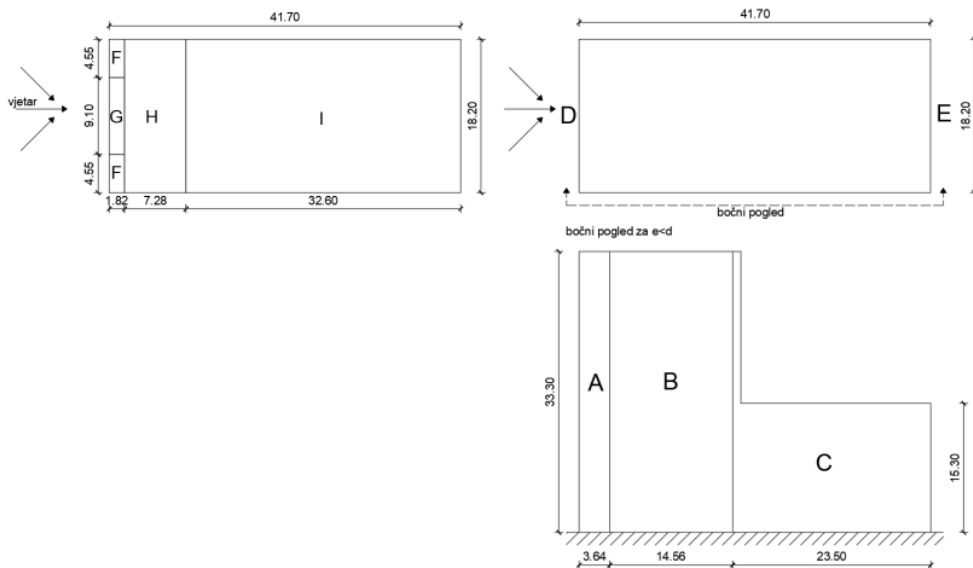

Slika 22. Koeficijenti vanjskog tlaka za zidove i ravne krovove za zgradu A – Slučaj 1 i 2

Ukupni tlak vjetra po površinama:

$$w_A = w_{e,A} + w_{i,max} = -0,61 - 0,10 = -0,71 \text{ kN/m}^2$$

$$w_B = w_{e,B} + w_{i,max} = -0,40 - 0,10 = -0,50 \text{ kN/m}^2$$

$$w_C = w_{e,C} + w_{i,max} = -0,25 - 0,10 = -0,35 \text{ kN/m}^2$$

$$w_D = w_{e,D} + w_{i,max} = +0,40 - 0,10 = +0,30 \text{ kN/m}^2$$

$$w_E = w_{e,E} + w_{i,max} = -0,25 - 0,10 = -0,35 \text{ kN/m}^2$$

$$w_F = w_{e,F} + w_{i,max} = -0,91 - 0,10 = -1,01 \text{ kN/m}^2$$

$$w_G = w_{e,G} + w_{i,max} = -0,61 - 0,10 = -0,71 \text{ kN/m}^2$$

$$w_H = w_{e,H} + w_{i,max} = -0,35 - 0,10 = -0,45 \text{ kN/m}^2$$

$$w_{I,min} = w_{e,I,min} + w_{i,max} = -0,10 - 0,10 = -0,20 \text{ kN/m}^2$$

$$w_{I,max} = w_{e,I,max} + w_{i,max} = +0,10 - 0,10 = 0,00 \text{ kN/m}^2$$

2.3.4.3 Slučaj 2 – vjetar puše u smjeru 0° (180°), $c_{pi} = -0,3$

Ukupni tlak vjetra po površinama:

$$w_A = w_{e,A} + w_{i,min} = -0,61 + 0,15 = -0,46 \text{ kN/m}^2$$

$$w_B = w_{e,B} + w_{i,min} = -0,40 + 0,15 = -0,25 \text{ kN/m}^2$$

$$w_C = w_{e,C} + w_{i,min} = -0,25 + 0,15 = -0,10 \text{ kN/m}^2$$

$$w_D = w_{e,D} + w_{i,min} = +0,40 + 0,15 = +0,55 \text{ kN/m}^2$$

$$w_E = w_{e,E} + w_{i,min} = -0,25 + 0,15 = -0,10 \text{ kN/m}^2$$

$$w_F = w_{e,F} + w_{i,min} = -0,91 + 0,15 = -0,76 \text{ kN/m}^2$$

$$w_G = w_{e,G} + w_{i,min} = -0,61 + 0,15 = -0,46 \text{ kN/m}^2$$

$$w_H = w_{e,H} + w_{i,min} = -0,35 + 0,15 = -0,20 \text{ kN/m}^2$$

$$w_{l,min} = w_{e,l,min} + w_{i,min} = -0,10 + 0,15 = -0,05 \text{ kN/m}^2$$

$$w_{l,max} = w_{e,l,max} + w_{i,min} = +0,10 + 0,15 = +0,25 \text{ kN/m}^2$$

2.3.4.4 Slučaj 3 – vjetar puše u smjeru 90°, $c_{pi} = +0,2$

$$h = 33,3 \text{ m}$$

$$e = \min(b; 2h) = \min(41,7; 66,6) = 41,7$$

$$d = 18,2 \text{ m} \rightarrow e > d$$

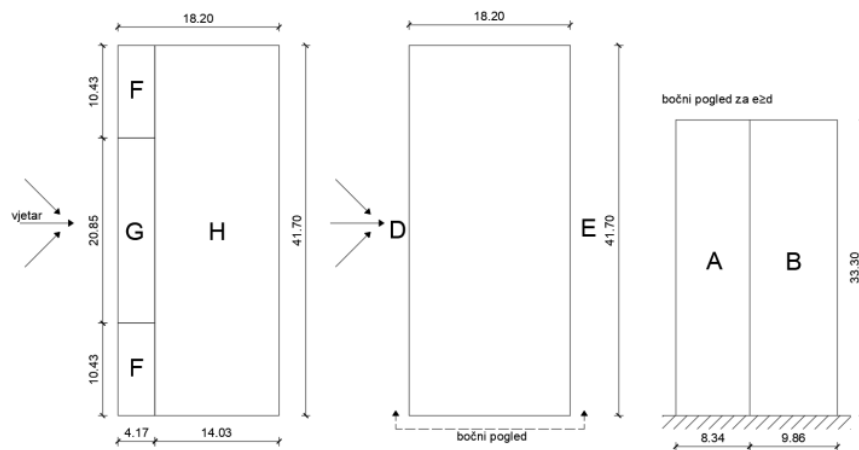

Slika 23. Koeficijenti vanjskog tlaka za zidove i ravne krovove za zgradu A – Slučaj 3 i 4

Ukupni tlak vjetra po površinama:

$$w_A = w_{e,A} + w_{i,max} = -0,61 - 0,10 = -0,71 \text{ kN/m}^2$$

$$w_B = w_{e,B} + w_{i,max} = -0,40 - 0,10 = -0,50 \text{ kN/m}^2$$

$$w_D = w_{e,D} + w_{i,max} = +0,40 - 0,10 = +0,30 \text{ kN/m}^2$$

$$w_E = w_{e,E} + w_{i,max} = -0,25 - 0,10 = -0,35 \text{ kN/m}^2$$

$$w_F = w_{e,F} + w_{i,max} = -0,91 - 0,10 = -1,01 \text{ kN/m}^2$$

$$w_G = w_{e,G} + w_{i,max} = -0,61 - 0,10 = -0,71 \text{ kN/m}^2$$

$$w_H = w_{e,H} + w_{i,max} = -0,35 - 0,10 = -0,45 \text{ kN/m}^2$$

2.3.4.5 Slučaj 4 – vjetar puše u smjeru 90° , $c_{pi} = -0,3$

Ukupni tlak vjetra po površinama:

$$w_A = w_{e,A} + w_{i,min} = -0,61 + 0,15 = -0,46 \text{ kN/m}^2$$

$$w_B = w_{e,B} + w_{i,min} = -0,40 + 0,15 = -0,25 \text{ kN/m}^2$$

$$w_D = w_{e,D} + w_{i,min} = +0,40 + 0,15 = +0,55 \text{ kN/m}^2$$

$$w_E = w_{e,E} + w_{i,min} = -0,25 + 0,15 = -0,10 \text{ kN/m}^2$$

$$w_F = w_{e,F} + w_{i,min} = -0,91 + 0,15 = -0,76 \text{ kN/m}^2$$

$$w_G = w_{e,G} + w_{i,min} = -0,61 + 0,15 = -0,46 \text{ kN/m}^2$$

$$w_H = w_{e,H} + w_{i,min} = -0,35 + 0,15 = -0,20 \text{ kN/m}^2$$

Slučaj 2 je mjerodavan za pritiskajuće djelovanje vjetra, dok je slučaj 3 mjerodavan za odižuće djelovanje vjetra.

2.3.4.6 Određivanje ukupnog tlaka vjetra po površinama za zgradu B

Iznosi vanjskog tlaka po površini bočnih ploha:

$$w_{e,A} = q_p(z_{e,B}) \cdot c_{pe,10,A} = 0,393 \cdot (-1,2) = -0,47 \text{ kN/m}^2$$

$$w_{e,B} = q_p(z_{e,B}) \cdot c_{pe,10,B} = 0,393 \cdot (-0,8) = -0,31 \text{ kN/m}^2$$

$$w_{e,C} = q_p(z_{e,B}) \cdot c_{pe,10,C} = 0,393 \cdot (-0,5) = -0,20 \text{ kN/m}^2$$

$$w_{e,D} = q_p(z_{e,B}) \cdot c_{pe,10,D} = 0,393 \cdot (+0,8) = +0,31 \text{ kN/m}^2$$

$$w_{e,E} = q_p(z_{e,B}) \cdot c_{pe,10,E} = 0,393 \cdot (-0,5) = -0,20 \text{ kN/m}^2$$

Iznosi vanjskog tlaka po površini krova:

$$w_{e,F} = q_p(z_{e,B}) \cdot c_{pe,10,F} = 0,393 \cdot (-1,8) = -0,71 \text{ kN/m}^2$$

$$w_{e,G} = q_p(z_{e,B}) \cdot c_{pe,10,G} = 0,393 \cdot (-1,2) = -0,47 \text{ kN/m}^2$$

$$w_{e,H} = q_p(z_{e,B}) \cdot c_{pe,10,H} = 0,393 \cdot (-0,7) = -0,28 \text{ kN/m}^2$$

$$w_{e,I,min} = q_p(z_{e,B}) \cdot c_{pe,10,I,min} = 0,393 \cdot (-0,2) = -0,08 \text{ kN/m}^2$$

$$w_{e,I,max} = q_p(z_{e,B}) \cdot c_{pe,10,I,max} = 0,393 \cdot (+0,2) = +0,08 \text{ kN/m}^2$$

Iznosi unutarnjeg tlaka za sve površine:

$$w_{i,max} = q_p(z_{i,A}) \cdot c_{pi,max} = 0,393 \cdot (+0,2) = +0,08 \text{ kN/m}^2$$

$$w_{i,min} = q_p(z_{i,A}) \cdot c_{pi,min} = 0,393 \cdot (-0,3) = -0,12 \text{ kN/m}^2$$

2.3.4.7 Slučaj 1 – vjetar puše u smjeru 0° (180°), $c_{pi} = +0,2$

$$h = 18,3 \text{ m}$$

$$e = \min(b; 2h) = \min(27,0; 36,6) = 27,0$$

$$d = 13,3 \text{ m} \rightarrow e > d$$

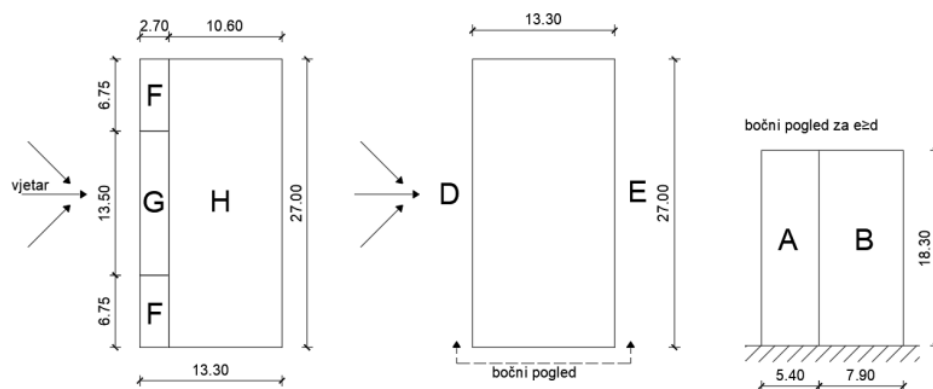

Slika 24. Koeficijenti vanjskog tlaka za zidove i ravne krovove za zgradu B – Slučaj 1 i 2

Ukupni tlak vjetra po površinama:

$$w_A = w_{e,A} + w_{i,max} = -0,47 - 0,08 = -0,55 \text{ kN/m}^2$$

$$w_B = w_{e,B} + w_{i,max} = -0,31 - 0,08 = -0,39 \text{ kN/m}^2$$

$$w_D = w_{e,D} + w_{i,max} = +0,31 - 0,08 = +0,23 \text{ kN/m}^2$$

$$w_E = w_{e,E} + w_{i,max} = -0,20 - 0,08 = -0,28 \text{ kN/m}^2$$

$$w_F = w_{e,F} + w_{i,max} = -0,71 - 0,08 = -0,79 \text{ kN/m}^2$$

$$w_G = w_{e,G} + w_{i,max} = -0,47 - 0,08 = -0,55 \text{ kN/m}^2$$

$$w_H = w_{e,H} + w_{i,max} = -0,28 - 0,08 = -0,36 \text{ kN/m}^2$$

2.3.4.8 Slučaj 2 – vjetar puše u smjeru 0° (180°), $c_{pi} = -0,3$

Ukupni tlak vjetra po površinama:

$$w_A = w_{e,A} + w_{i,max} = -0,47 + 0,12 = -0,35 \text{ kN/m}^2$$

$$w_B = w_{e,B} + w_{i,max} = -0,31 + 0,12 = -0,19 \text{ kN/m}^2$$

$$w_D = w_{e,D} + w_{i,max} = +0,31 + 0,12 = +0,43 \text{ kN/m}^2$$

$$w_E = w_{e,E} + w_{i,max} = -0,20 + 0,12 = -0,08 \text{ kN/m}^2$$

$$w_F = w_{e,F} + w_{i,max} = -0,71 + 0,12 = -0,59 \text{ kN/m}^2$$

$$w_G = w_{e,G} + w_{i,max} = -0,47 + 0,12 = -0,35 \text{ kN/m}^2$$

$$w_H = w_{e,H} + w_{i,max} = -0,28 + 0,12 = -0,16 \text{ kN/m}^2$$

2.3.4.9 Slučaj 3 – vjetar puše u smjeru 90° , $c_{pi} = +0,2$

$$h = 18,3 \text{ m}$$

$$e = \min(b; 2h) = \min(13,3; 36,6) = 13,3$$

$$d = 27,0 \text{ m} \rightarrow e < d$$

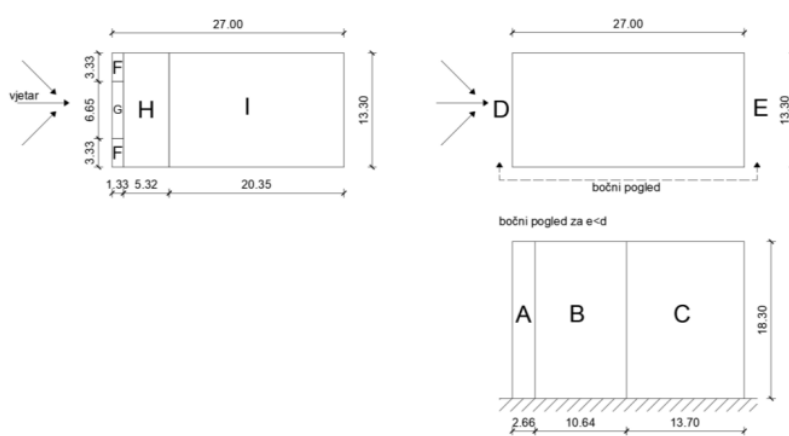

Slika 25. Koeficijenti vanjskog tlaka za zidove i ravne krovove za zgradu A – Slučaj 3 i 4

Ukupni tlak vjetra po površinama:

$$w_A = w_{e,A} + w_{i,max} = -0,47 - 0,08 = -0,55 \text{ kN/m}^2$$

$$w_B = w_{e,B} + w_{i,max} = -0,31 - 0,08 = -0,39 \text{ kN/m}^2$$

$$w_C = w_{e,C} + w_{i,max} = -0,20 - 0,08 = -0,28 \text{ kN/m}^2$$

$$w_D = w_{e,D} + w_{i,max} = +0,31 - 0,08 = +0,23 \text{ kN/m}^2$$

$$w_E = w_{e,E} + w_{i,max} = -0,20 - 0,08 = -0,28 \text{ kN/m}^2$$

$$w_F = w_{e,F} + w_{i,max} = -0,71 - 0,08 = -0,79 \text{ kN/m}^2$$

$$w_G = w_{e,G} + w_{i,max} = -0,47 - 0,08 = -0,55 \text{ kN/m}^2$$

$$w_H = w_{e,H} + w_{i,max} = -0,28 - 0,08 = -0,36 \text{ kN/m}^2$$

$$w_{l,min} = w_{e,l,min} + w_{i,max} = -0,08 - 0,08 = -0,16 \text{ kN/m}^2$$

$$w_{l,max} = w_{e,l,max} + w_{i,max} = +0,08 - 0,08 = 0,00 \text{ kN/m}^2$$

2.3.4.10 Slučaj 4 – vjetar puše u smjeru 90° , $c_{pi} = -0,3$

Ukupni tlak vjetra po površinama:

$$w_A = w_{e,A} + w_{i,max} = -0,47 + 0,12 = -0,35 \text{ kN/m}^2$$

$$w_B = w_{e,B} + w_{i,max} = -0,31 + 0,12 = -0,19 \text{ kN/m}^2$$

$$w_C = w_{e,C} + w_{i,max} = -0,20 + 0,12 = -0,08 \text{ kN/m}^2$$

$$w_D = w_{e,D} + w_{i,max} = +0,31 + 0,12 = +0,43 \text{ kN/m}^2$$

$$w_E = w_{e,E} + w_{i,max} = -0,20 + 0,12 = -0,08 \text{ kN/m}^2$$

$$w_F = w_{e,F} + w_{i,max} = -0,71 + 0,12 = -0,59 \text{ kN/m}^2$$

$$w_G = w_{e,G} + w_{i,max} = -0,47 + 0,12 = -0,35 \text{ kN/m}^2$$

$$w_H = w_{e,H} + w_{i,max} = -0,28 + 0,12 = -0,16 \text{ kN/m}^2$$

$$w_{l,min} = w_{e,l,min} + w_{i,max} = -0,08 + 0,12 = +0,04 \text{ kN/m}^2$$

$$w_{l,max} = w_{e,l,max} + w_{i,max} = +0,08 + 0,12 = +0,20 \text{ kN/m}^2$$

Slučaj 1 je mjerodavan za odižuće djelovanje vjetra, dok je slučaj 4 mjerodavan za pritiskajuće djelovanje vjetra.

2.3.5 Potresno opterećenje

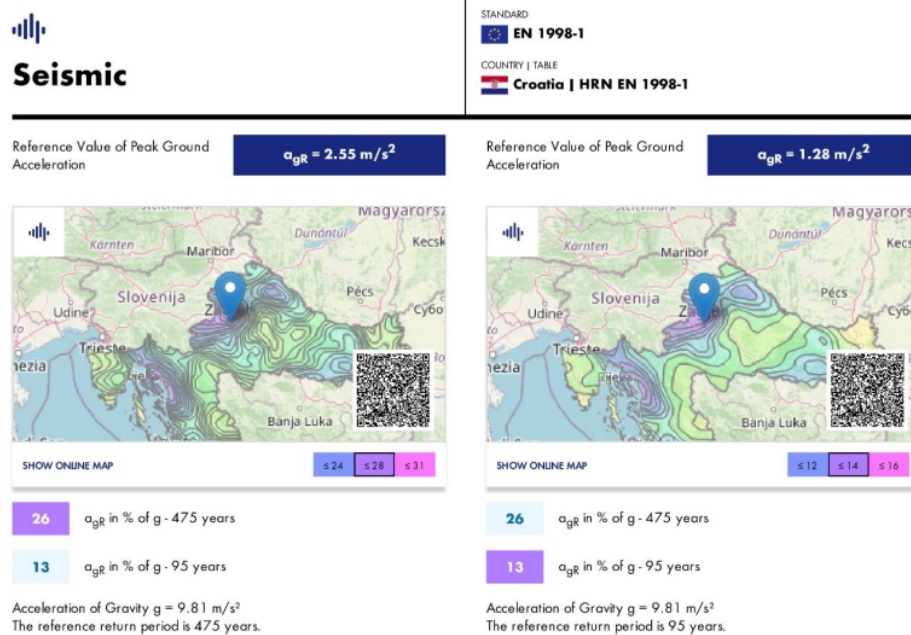

Slika 26. Prikaz povratnih perioda i ubrzanja tla za Zagreb

- tip tla: C
- tip spektra: 1
- faktor tla: $S = 1,0$
- donja granica perioda s granom konstantnog spektralnog ubrzanja: $T_B = 0,05 \text{ s}$
- gornja granica perioda s granom konstantnog spektralnog ubrzanja: $T_C = 0,15 \text{ s}$
- vrijednost perioda koja definira početak konstantnog spektralnog pomaka: $T_D = 1,0 \text{ s}$
- horizontalno vršno ubrzanje tla za povratno razdoblje $T_p = 475 \text{ god}$: $a_{g,R} = 0,255$
- proračunsko vršno ubrzanje tla: $a_g = a_{g,R} \cdot \gamma_i = 0,255 \text{ m/s}^2$
- faktor ponašanja: $q = 2,5$
- klasa važnosti: II – obične zgrade koje ne pripadaju drugim skupinama
- $\gamma_i = 1,0$

2.4 Statički proračun

2.4.1 Proračun zgrade A (P+10)

Marija Gulam



Model:

diplomski_zgradaA1

Date 21.8.2024 Page 1/38

Sheet 1

MODEL

CONTENTS

1	Basic Objects	2	6	Dynamic Loads	19
1.1	Materials	2	6.1	Response Spectra	19
1.2	Sections	2	6.1.1	Response Spectra - Parameters	19
1.3	Thicknesses	2	6.2	Response Spectra Diagram	19
1.3.1	Thicknesses - Layer Info	2	7	Static Analysis Results	19
1.3.2	Thicknesses - Layers	2	7.1	CO10: Basic Internal Forces m_x , In Axonometric	20
1.3.3	Thicknesses - Options for CLT	3		Axonometric Direction	
1.4	Model, In Axonometric Direction	4	7.2	CO10: Basic Internal Forces m_y , In Axonometric	21
1.5	Model, In Axonometric Direction	5		Axonometric Direction	
1.6	Model, In Axonometric Direction	6	7.3	CO10: Basic Internal Forces n_x , In Axonometric	22
1.7	Model, In Axonometric Direction	7		Direction	
2	Special Objects	8	7.4	CO10: Basic Internal Forces n_y , In Axonometric	23
2.1	Nodal Releases	8		Direction	
3	Types for Surfaces	8	7.5	CO57: Global Deformations $ \mu $, In Axonometric	24
3.1	Surface Supports	8		Direction	
4	Types for Special Objects	8	7.6	CO104: Global Deformations $ \mu $, In Axonometric	25
4.1	Nodal Release Types	8		Direction	
4.2		8	7.7	CO10: Forces n_x , In Axonometric Direction	26
5	Load Cases & Combinations	8	7.8	CO10: Forces v_x , In Axonometric Direction	27
5.1	Load Cases	8	7.9	CO10: Forces v_y , In Axonometric Direction	28
5.2	Static Analysis Settings	9	8	Modal Analysis Results	29
5.3	Modal Analysis Settings	10	8.1	Natural Frequencies	29
5.4	Spectral Analysis Settings	11	8.2	Effective Modal Masses	29
5.5	Combination Wizards	11	8.3	Effective Modal Masses - Equivalent Mass per	30
5.5.1	Combination Wizards - Initial State Items	12		Unit Length	
A	LC2: Loading, In Axonometric Direction	13	8.4	LC9: Mode Shape $ \mu $, In Axonometric Direction	31
B	LC3: Loading, In Axonometric Direction	14	8.5	LC9: Mode Shape $ \mu $, In Axonometric Direction	32
C	LC5: Loading, In Axonometric Direction	15	8.6	LC9: Mode Shape $ \mu $, In Axonometric Direction	33
D	LC4: Loading, In Axonometric Direction	16	8.7	LC9: Mode Shape $ \mu $, In Axonometric Direction	34
E	LC6: Loading, In Axonometric Direction	17	8.8	LC9: Mode Shape $ \mu $, In Axonometric Direction	35
F	LC7: Loading, In Axonometric Direction	18	8.9	LC9: Mode Shape $ \mu $, In Axonometric Direction	36
			G	LC10: Envelope Values - Max and Min Values,	37
				Global Deformations $ \mu $, In Axonometric Direction	
			H	LC10: Envelope Values - Max and Min Values,	38
				Global Deformations $ \mu $, In Axonometric Direction	



Marija Gulam



Model: diplomski_zgradaA1

Date 21.8.2024 Page 2/38
Sheet 1

MODEL

1 Basic Objects

1.1 MATERIALS

Legend
 Concrete Settings
 Stiffness modification

Material No.	Material Name	Material Type	Analysis Model	Options
1	C24 BBS XL Orthotropic Linear Elastic (Surfaces)	Timber	Orthotropic Linear Elastic (Surfaces)	
2	C24 BBS XL Orthotropic Linear Elastic (Surfaces)	Timber	Orthotropic Linear Elastic (Surfaces)	
3	GL32h Isotropic Linear Elastic	Timber	Isotropic Linear Elastic	
4	C35/45 Isotropic Linear Elastic	Concrete	Isotropic Linear Elastic	

1.2 SECTIONS

Section No.	Material No.	Section Type	Manufacturing Type	I _x [cm ⁴]	I _y [cm ⁴]	I _z [cm ⁴]	Overall Dimensions
				A [cm ²]	A _y [cm ²]	A _z [cm ²]	b [mm] h [mm]
1	R_M1 200/200 3 - GL32h	Parametric - Massive I		22533.33	13333.33	13333.33	200.0 200.0
				400.00	333.33	333.33	

R_M1 200/200



1.3 THICKNESSES

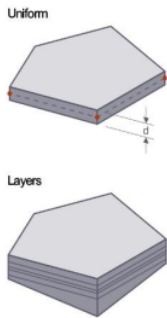

Thick. No.	Type	Assigned to Surface No.	Material	Symbol	Thickness Value	Unit	Nodes	Direction
1	Layers d : 220.0 mm Layers: 7 Layers	11,12,20,71,73,75,77,97-99,116,18,154-157,171-192,204-206,212-214,221-223,229-231,267-273,298-304,343,408-410,413-415,418-420,423-425,526						
2	Layers d : 140.0 mm Layers: 5 Layers	1-10,13,14,21-31,43-53,70,72,74,76,78,100-104,106-114,117,120-129,139-142,159-170,208-211,216-220,225-228,233-236,257,258,262-266,315-342,348-364,366-381,383-407,411,412,416,417,421,422,426,427						
3	Uniform d : 200.0 mm 4 - C35/45 Uniform	32-42,59-69,115,119,143-153,158,193-203,207,215,224,232,274-296,305	4	d	200.0	mm		

1.3.1 THICKNESSES - LAYER INFO

Thick. No.	Total Thickness d [mm]	Total Weight g [N/m ²]	Direction of Main Thickness	Comment
1	220.0	990.0	0.00	
2	140.0	630.0	0.00	

1.3.2 THICKNESSES - LAYERS

Thick. No.	Layer No.	Object	Material	Thickness t [mm]	Rotation β [deg]	Number of Int. Points	Spec. W g [N/m ²]	Weight g [N/m ²]
1	1	Directly	1	40.0	0.00	9	4500.0	180.0
	2	Directly	2	40.0	90.00	9	4500.0	180.0
	3	Directly	1	20.0	0.00	9	4500.0	90.0
	4	Directly	2	20.0	90.00	9	4500.0	90.0
	5	Directly	1	20.0	0.00	9	4500.0	90.0
	6	Directly	2	40.0	90.00	9	4500.0	180.0
	7	Directly	1	40.0	0.00	9	4500.0	180.0
2	1	Directly	1	40.0	0.00	9	4500.0	180.0



Marija Gulam



Model:
diplomski_zgradaA1

Date 21.8.2024 Page 3/38
Sheet 1

MODEL

1.3.2 THICKNESSES - LAYERS

Thick. No.	Layer No.	Object	Material	Thickness t [mm]	Rotation β [deg]	Number of Int. Points	Spec. W. g [N/m ²]	Weight g [N/m ²]
	2	Directly	2	20.0	90.00	9	4500.0	90.0
	3	Directly	1	20.0	0.00	9	4500.0	90.0
	4	Directly	2	20.0	90.00	9	4500.0	90.0
	5	Directly	1	40.0	0.00	9	4500.0	180.0

1.3.3 THICKNESSES - OPTIONS FOR CLT

Thick. No.	Name	Options for CLT	Symbol	Value	Unit
1	Design for failure of net section and failure in glued contact surface is enabled.			<input type="checkbox"/>	
2	Design for failure of net section and failure in glued contact surface is enabled.			<input type="checkbox"/>	



Marija Gulam



Model:
diplomski_zgradaA1

Date 21.8.2024 Page 4/38
Sheet 1

MODEL

1.4 **MODEL, IN AXONOMETRIC DIRECTION**

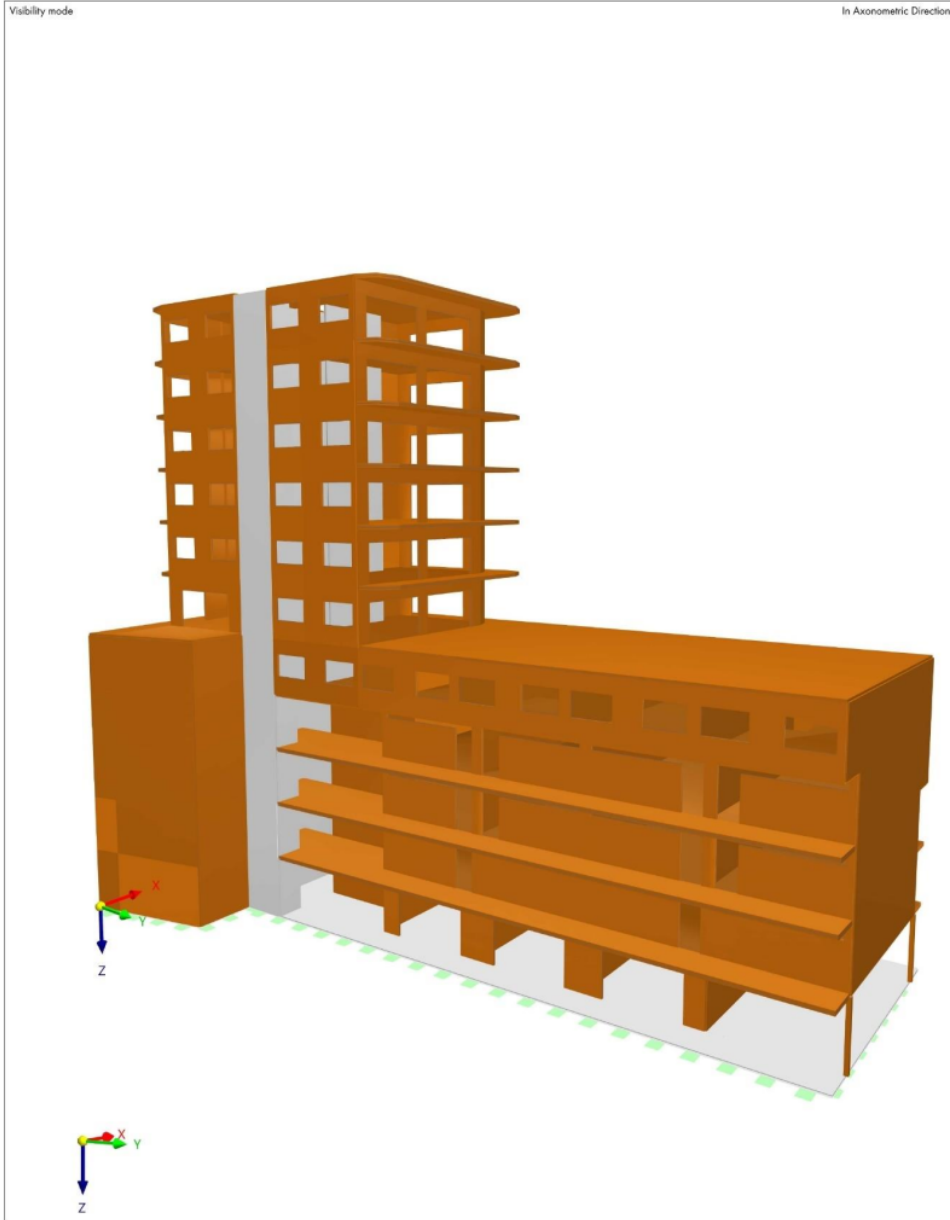

Marija Gulam



Model:
diplomski_zgradaA1

Date 21.8.2024 Page 5/38
Sheet 1

MODEL

1.5 MODEL, IN AXONOMETRIC DIRECTION

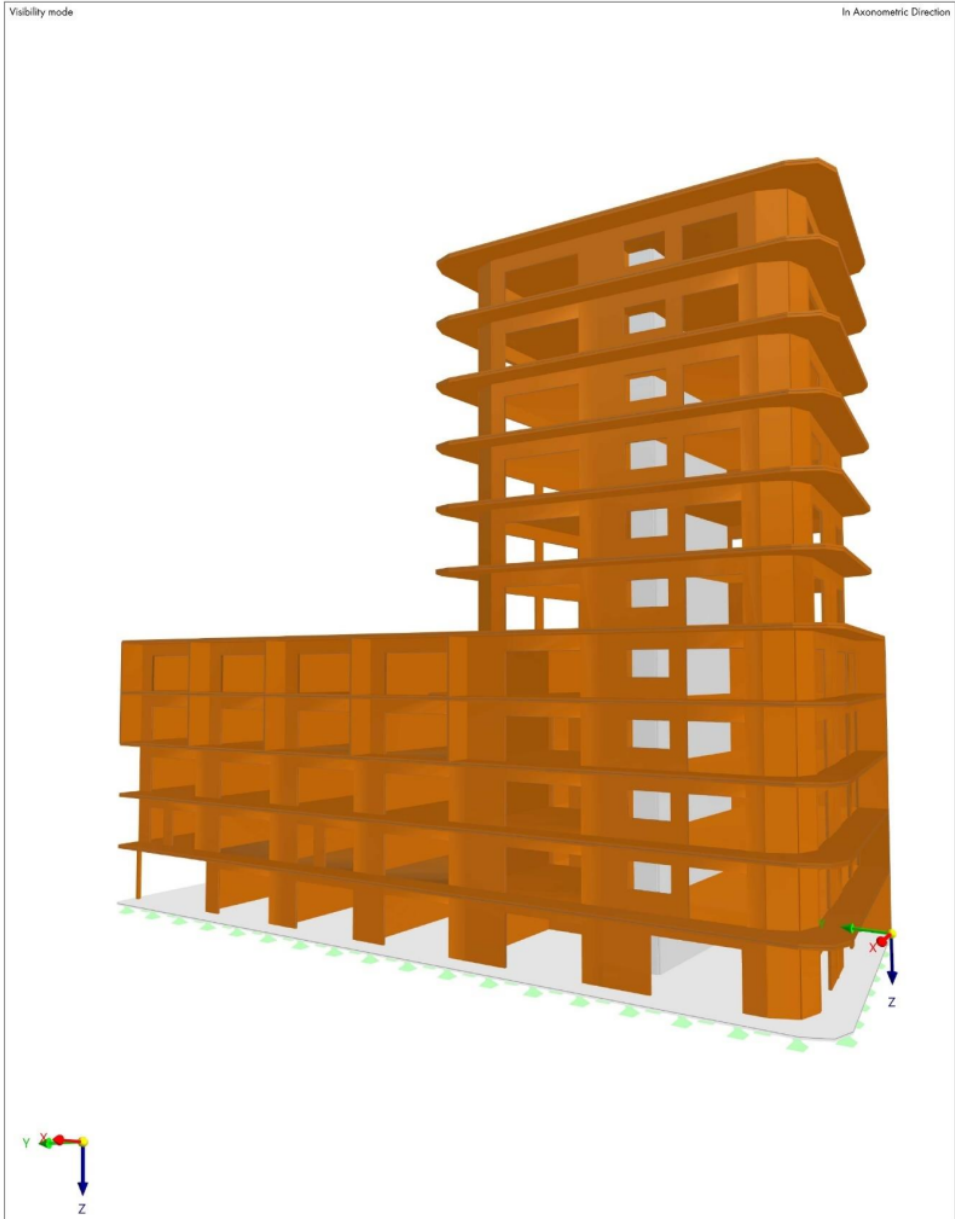

Marija Gulam



Model: diplomski_zgradaA1

Date 21.8.2024 Page 6/38
Sheet 1

MODEL

1.6 MODEL, IN AXONOMETRIC DIRECTION

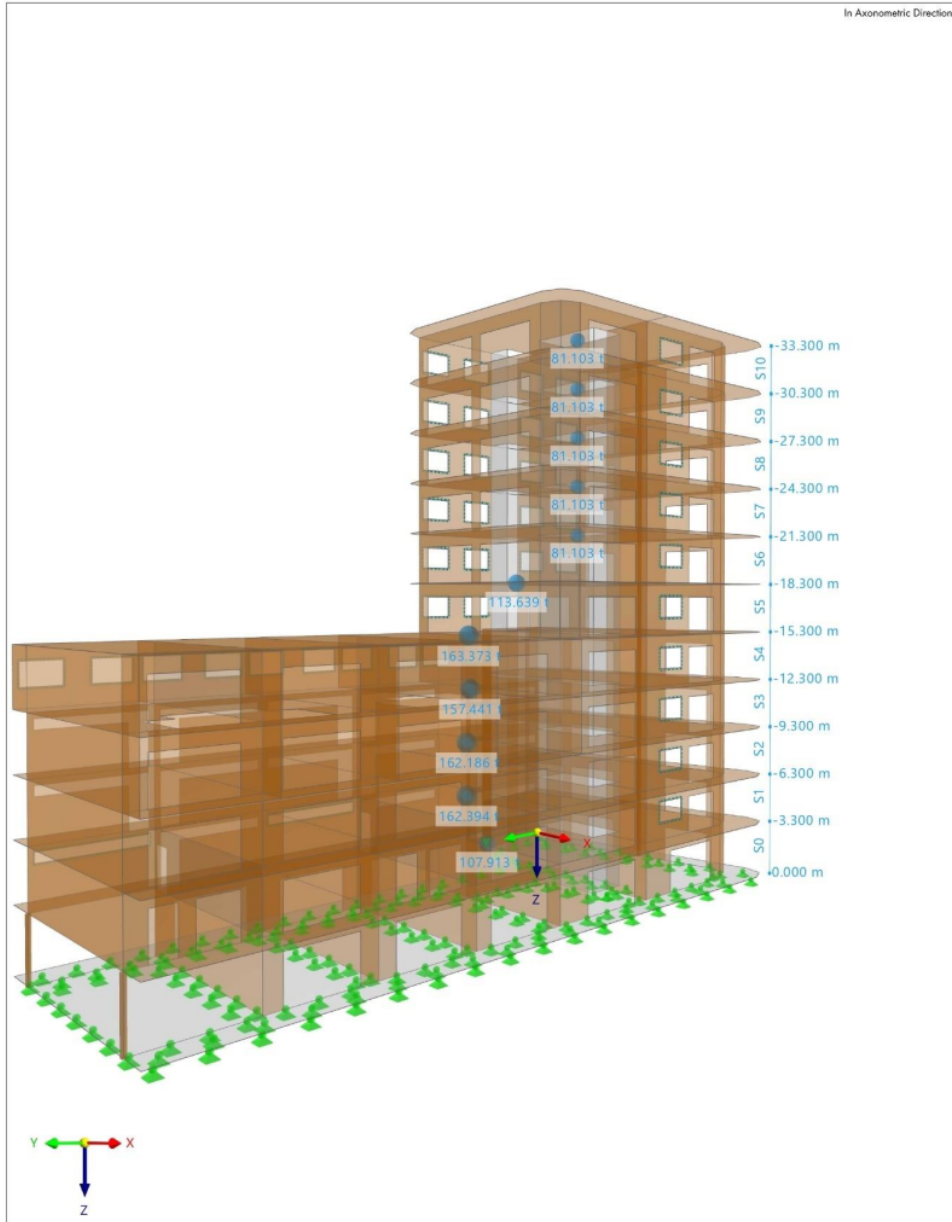

Marija Gulam



Model:
diplomski_zgradaA1

Date 21.8.2024 Page 7/38
Sheet 1

MODEL

1.7 MODEL, IN AXONOMETRIC DIRECTION

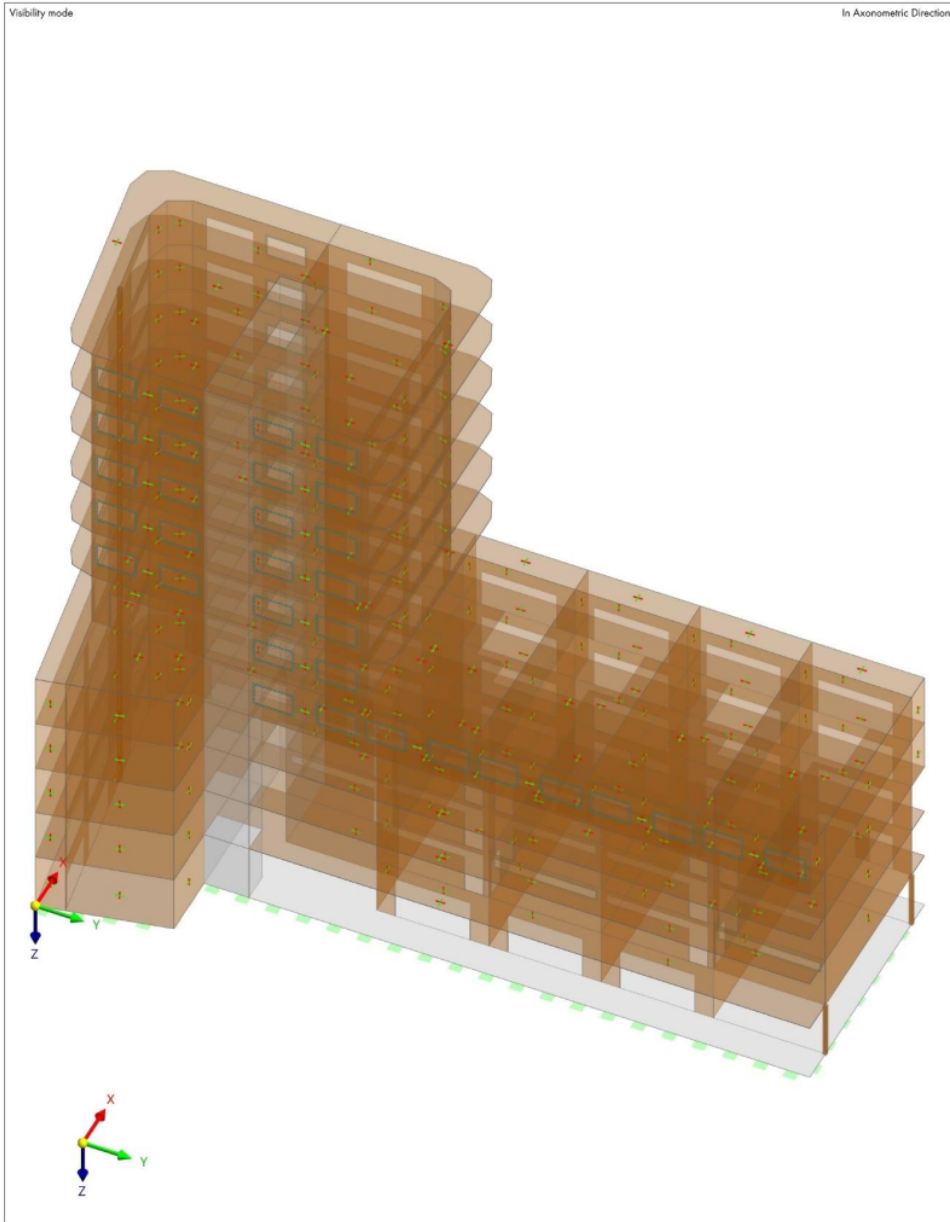

Marija Gulam



Model: diplomski_zgradaA1

Date 21.8.2024 Page 8/38
Sheet 1

MODEL

2 Special Objects

2.1 NODAL RELEASES

Release No.	Name	Value
1	<input type="checkbox"/> <input type="checkbox"/> <input type="checkbox"/> <input checked="" type="checkbox"/> 1 - Global XYZ Original node (Nodes : 408,1015)	
	Nodes	408,1015
	Nodal Release Type	1 - <input type="checkbox"/> <input type="checkbox"/> <input checked="" type="checkbox"/> 1 - Global XYZ
	Released Members	1,2
	Released Surfaces	
	Released Solids	
	Release Location	Original node
	Generated released nodes	
	Deactivated	<input type="checkbox"/>

3 Types for Surfaces

3.1 SURFACE SUPPORTS

Support No.	Surfaces No.	C_{ux} [kN/m ²]	Translational Spring [kN/m ²]			Shear Spring [kN/m]	
			C_{ux}	C_{uy}	C_{uz}	C_{sxz}	C_{syx}
1	<input checked="" type="checkbox"/> <input checked="" type="checkbox"/> <input checked="" type="checkbox"/> Rigid 115,158,207,215,224, 232,274,305	<input checked="" type="checkbox"/>	<input checked="" type="checkbox"/>	<input checked="" type="checkbox"/>	<input checked="" type="checkbox"/>	<input checked="" type="checkbox"/>	<input checked="" type="checkbox"/>

4 Types for Special Objects

4.1 NODAL RELEASE TYPES

Release Type No.	Coordinate System	Local Axis System Object Type	No.	Translation Spring [kN/m]			Rotation Spring [kNm/rad]		
				C_{ux}	C_{uy}	C_{uz}	$C_{\theta x}$	$C_{\theta y}$	$C_{\theta z}$
1	<input type="checkbox"/> <input type="checkbox"/> <input checked="" type="checkbox"/> 1 - Global XYZ			<input type="checkbox"/>	<input type="checkbox"/>	<input type="checkbox"/>	<input type="checkbox"/>	<input checked="" type="checkbox"/>	<input checked="" type="checkbox"/>

4.2 LINE RELEASE TYPES

Release No.	Local Axis System		Translational Spring [kN/m ²]			Spring Constant [kNm·rad ⁻¹ ·m ⁻¹]	Rot. Angle β [deg]
	Type	No.	C_{ux}	C_{uy}	C_{uz}	$C_{\theta x}$	
1	<input type="checkbox"/> <input type="checkbox"/> <input checked="" type="checkbox"/> Line Releases: 1-49 Original line		<input type="checkbox"/>	<input type="checkbox"/>	<input type="checkbox"/>	<input checked="" type="checkbox"/>	0.00

5 Load Cases & Combinations

5.1 LOAD CASES

LC No.	Settings	Value	Unit	To Solve
1	<input checked="" type="checkbox"/> Self-weight			
	Analysis type	Static Analysis		<input checked="" type="checkbox"/>
	Associated standard	EN 1990 Base + Timber CEN 2010-04		
	Static analysis settings	SA1 - Geometrically linear Newton-Raphson		
	Action category	<input checked="" type="checkbox"/> Permanent		
	Self-weight - Factor in direction X	0.000	-	
	Self-weight - Factor in direction Y	0.000	-	
	Self-weight - Factor in direction Z	1.000	-	
	Load duration	Permanent		
	Self-weight mode for geotechnical analysis	Normal		
2	<input checked="" type="checkbox"/> Dodatno stalno			
	Analysis type	Static Analysis		<input checked="" type="checkbox"/>
	Associated standard	EN 1990 Base + Timber CEN 2010-04		
	Static analysis settings	SA1 - Geometrically linear Newton-Raphson		
	Action category	<input checked="" type="checkbox"/> Permanent		
	Load duration	Permanent		
	Self-weight mode for geotechnical analysis	Normal		
3	<input checked="" type="checkbox"/> Uporabno			
	Analysis type	Static Analysis		<input checked="" type="checkbox"/>





LOADS

5.1 LOAD CASES

LC No.	Settings	Value	Unit	To Solve
	Associated standard	EN 1990 Base + Timber CEN 2010-04		
	Static analysis settings	SA1 - Geometrically linear Newton-Raphson		
	Action category	Imposed loads - category A: domestic, residential areas		
	Load duration	Medium-term		
	Factor Phi	Independently occupied floors		
	Self-weight mode for geotechnical analysis	Normal		
	Imposed load is considered as fatigue	<input type="checkbox"/>		
4	Srijeg			
	Analysis type	Static Analysis		<input checked="" type="checkbox"/>
	Associated standard	EN 1990 Base + Timber CEN 2010-04		
	Static analysis settings	SA1 - Geometrically linear Newton-Raphson		
	Action category	Snow/ice loads - H <= 1000 m		
	Load duration	Short-term		
	Self-weight mode for geotechnical analysis	Normal		
5	Uporabno krov			
	Analysis type	Static Analysis		<input checked="" type="checkbox"/>
	Associated standard	EN 1990 Base + Timber CEN 2010-04		
	Static analysis settings	SA1 - Geometrically linear Newton-Raphson		
	Action category	Imposed loads - category A: domestic, residential areas		
	Load duration	Medium-term		
	Factor Phi	Roofs		
	Self-weight mode for geotechnical analysis	Normal		
	Imposed load is considered as fatigue	<input type="checkbox"/>		
6	Vjetar			
	Analysis type	Static Analysis		<input checked="" type="checkbox"/>
	Associated standard	EN 1990 Base + Timber CEN 2010-04		
	Static analysis settings	SA1 - Geometrically linear Newton-Raphson		
	Action category	Wind		
	Load duration	Short-term		
	Self-weight mode for geotechnical analysis	Normal		
7	Vjetar odizuc			
	Analysis type	Static Analysis		<input checked="" type="checkbox"/>
	Associated standard	EN 1990 Base + Timber CEN 2010-04		
	Static analysis settings	SA1 - Geometrically linear Newton-Raphson		
	Action category	Wind		
	Load duration	Short-term		
	Self-weight mode for geotechnical analysis	Normal		
9	Potres_modalna			
	Analysis type	Modal Analysis		<input checked="" type="checkbox"/>
	Associated standard	EN 1990 Base + Timber CEN 2010-04		
	Modal analysis settings	MOS1 - #30 Lanczos		
	Import masses from	CO162		
	Action category	Seismic actions		
	Self-weight mode for geotechnical analysis	Normal		
10	Potres_spektar			
	Analysis type	Response Spectrum Analysis		<input checked="" type="checkbox"/>
	Associated standard	EN 1990 Base + Timber CEN 2010-04		
	Spectral analysis settings	SPS1 - SRSS Scaled Sum 30.00 %		
	Import modal analysis from	LC9		
	Action category	Seismic actions		
	Load duration	Instantaneous		
	Self-weight mode for geotechnical analysis	Normal		

5.2 STATIC ANALYSIS SETTINGS

Settings No.	Description	Symbol	Value	Unit
1	Geometrically linear Newton-Raphson			
	Analysis type		Geometrically linear	
	Iterative method for nonlinear analysis		Newton-Raphson	
	Maximum number of iterations		100	
	Number of load increments		1	
	Modify standard precision and tolerance settings	<input type="checkbox"/>		
	Ignore all nonlinearities	<input type="checkbox"/>		
	Modify loading by multiplier factor	<input type="checkbox"/>		
	Displacements due to member load of type 'Pipe internal pressure' (Bourdon effect)	<input type="checkbox"/>		
	Method for equation system		Direct	





5.2 **STATIC ANALYSIS SETTINGS**

Settings No.	Description	Symbol	Value	Unit
	Plate bending theory		Mindlin	
	Activate mass conversion to load		<input type="checkbox"/>	
	Asymmetric direct solver		<input checked="" type="checkbox"/>	
	Equilibrium for undeformed structure		<input type="checkbox"/>	
	Stability check based on deformation rate		<input type="checkbox"/>	
2	Second-order (P-Δ) Picard 100 1		Second-order (P-Δ) Picard 100 1	
	Analysis type		Second-order (P-Δ)	
	Iterative method for nonlinear analysis		Picard	
	Maximum number of iterations		100	
	Number of load increments		1	
	Modify standard precision and tolerance settings		<input type="checkbox"/>	
	Ignore all nonlinearities		<input type="checkbox"/>	
	Modify loading by multiplier factor		<input type="checkbox"/>	
	Consider favorable effect due to tension in members		<input checked="" type="checkbox"/>	
	Displacements due to member load of type 'Pipe internal pressure' (Bourdon effect)		<input type="checkbox"/>	
	Refer internal forces to deformed structure		<input checked="" type="checkbox"/>	
	Refer internal forces to deformed structure for axial forces		<input checked="" type="checkbox"/>	
	Refer internal forces to deformed structure for shear forces		<input checked="" type="checkbox"/>	
	Refer internal forces to deformed structure for moments		<input checked="" type="checkbox"/>	
	Method for equation system		Direct	
	Plate bending theory		Mindlin	
	Activate mass conversion to load		<input type="checkbox"/>	
	Asymmetric direct solver		<input checked="" type="checkbox"/>	
	Equilibrium for undeformed structure		<input type="checkbox"/>	
	Stability check based on deformation rate		<input type="checkbox"/>	
3	Large deformations Newton-Raphson 100 1		Large deformations Newton-Raphson 100 1	
	Analysis type		Large deformations	
	Iterative method for nonlinear analysis		Newton-Raphson	
	Maximum number of iterations		100	
	Number of load increments		1	
	Modify standard precision and tolerance settings		<input type="checkbox"/>	
	Ignore all nonlinearities		<input type="checkbox"/>	
	Modify loading by multiplier factor		<input type="checkbox"/>	
	Consider favorable effect due to tension in members		<input checked="" type="checkbox"/>	
	Try to calculate unstable structure		<input type="checkbox"/>	
	Displacements due to member load of type 'Pipe internal pressure' (Bourdon effect)		<input type="checkbox"/>	
	Method for equation system		Direct	
	Plate bending theory		Mindlin	
	Activate mass conversion to load		<input type="checkbox"/>	
	Asymmetric direct solver		<input checked="" type="checkbox"/>	
	Equilibrium for undeformed structure		<input type="checkbox"/>	
	Stability check based on deformation rate		<input type="checkbox"/>	

5.3 **MODAL ANALYSIS SETTINGS**

Settings No.	Description	Symbol	Value	Unit
1	#30 Lanczos		User-Defined	
	Number of modes method		User-Defined	
	Number of modes		30	
	Solution method		Lanczos	
	Mass matrix type		Consistent	
	Acting masses in X-direction enabled	u _x	<input checked="" type="checkbox"/>	
	Acting masses in Y-direction enabled	u _y	<input checked="" type="checkbox"/>	
	Acting masses in Z-direction enabled	u _z	<input type="checkbox"/>	
	Acting masses about X-axis enabled	φ _x	<input type="checkbox"/>	
	Acting masses about Y-axis enabled	φ _y	<input type="checkbox"/>	
	Acting masses about Z-axis enabled	φ _z	<input type="checkbox"/>	
	Mass conversion type		Z-components of loads	
	Neglect masses		User-Defined	
2	#10 Lanczos		User-Defined	
	Number of modes method		User-Defined	
	Number of modes		10	
	Solution method		Lanczos	
	Mass matrix type		Consistent	
	Acting masses in X-direction enabled	u _x	<input checked="" type="checkbox"/>	
	Acting masses in Y-direction enabled	u _y	<input checked="" type="checkbox"/>	
	Acting masses in Z-direction enabled	u _z	<input checked="" type="checkbox"/>	
	Acting masses about X-axis enabled	φ _x	<input checked="" type="checkbox"/>	



Marija Gulam



Model:
diplomski_zgradaA1

Date 21.8.2024 Page 11/38
Sheet 1

MODEL

5.3 MODAL ANALYSIS SETTINGS

Settings No.	Description	Symbol	Value	Unit
	Acting masses about Y-axis enabled	ϕ_y	<input checked="" type="checkbox"/>	
	Acting masses about Z-axis enabled	ϕ_z	<input checked="" type="checkbox"/>	
	Mass conversion type		Z-components of loads	
	Neglect masses		No neglection	

5.4 SPECTRAL ANALYSIS SETTINGS

Settings No.	Description	Symbol	Value	Unit
1	SRSS Scaled Sum 30.00 %			
	Combination rule for periodic responses		SRSS	
	Use equivalent linear combination		<input type="checkbox"/>	
	Signed results using dominant mode		<input type="checkbox"/>	
	Save results of all selected modes		<input checked="" type="checkbox"/>	
	Combination rule for directional components		Scaled Sum	
	Combination rule for directional components		30.00	%
	Consider independent directions in envelope results		<input type="checkbox"/>	

5.5 COMBINATION WIZARDS

Wizard No.	Settings	Value
1	Load combinations SA1 - Geometrically linear Newton-Raphson	
	Assigned to	DS 1-6
	Generate combinations	Load combinations (non-linear analysis)
	Static analysis settings	SA1 - Geometrically linear Newton-Raphson
	Consider imperfection case	<input checked="" type="checkbox"/>
	Consider initial state	<input type="checkbox"/>
	Structure modification enabled	<input type="checkbox"/>
	Generate same combinations without imperfection case	<input type="checkbox"/>
	User-defined action combinations	<input type="checkbox"/>
	Favorable permanent actions	<input type="checkbox"/>
	Reduce number of generated combinations	<input type="checkbox"/>
	Assigned to	DS 1-6
	Generate combinations	Load combinations (non-linear analysis)
	Static analysis settings	SA1 - Geometrically linear Newton-Raphson
	Consider imperfection case	<input checked="" type="checkbox"/>
	Consider initial state	<input type="checkbox"/>
	Structure modification enabled	<input type="checkbox"/>
	Generate same combinations without imperfection case	<input type="checkbox"/>
	User-defined action combinations	<input type="checkbox"/>
	Favorable permanent actions	<input type="checkbox"/>
	Reduce number of generated combinations	<input type="checkbox"/>
2	Load combinations SA1 - Geometrically linear Newton-Raphson	
	Assigned to	Load combinations (non-linear analysis)
	Generate combinations	SA1 - Geometrically linear Newton-Raphson
	Static analysis settings	
	Consider imperfection case	<input type="checkbox"/>
	Consider initial state	<input type="checkbox"/>
	Structure modification enabled	<input type="checkbox"/>
	User-defined action combinations	<input type="checkbox"/>
	Favorable permanent actions	<input type="checkbox"/>
	Reduce number of generated combinations	<input type="checkbox"/>
	Assigned to	Load combinations (non-linear analysis)
	Generate combinations	SA1 - Geometrically linear Newton-Raphson
	Static analysis settings	
	Consider imperfection case	<input type="checkbox"/>
	Consider initial state	<input type="checkbox"/>
	Structure modification enabled	<input type="checkbox"/>
	User-defined action combinations	<input type="checkbox"/>
	Favorable permanent actions	<input type="checkbox"/>
	Reduce number of generated combinations	<input type="checkbox"/>
3	Result combinations	
	Assigned to	DS 7
	Generate combinations	Result combinations (linear analysis)
	Consider imperfection case	<input type="checkbox"/>
	Generate as permanent superposition	<input checked="" type="checkbox"/>
	User-defined action combinations	<input type="checkbox"/>
	Favorable permanent actions	<input type="checkbox"/>
	Assigned to	DS 7
	Generate combinations	Result combinations (linear analysis)
	Consider imperfection case	<input type="checkbox"/>



Marija Gulam



Model:
diplomski_zgradaA1

Date 21.8.2024 Page 12/38
Sheet 1

MODEL

5.5 COMBINATION WIZARDS

Wizard No.	Settings	Value
	User-defined action combinations	<input type="checkbox"/>
	Favorable permanent actions	<input type="checkbox"/>

5.5.1 COMBINATION WIZARDS - INITIAL STATE ITEMS

Wizard No.	Definition Type	Case Object
1	Load combinations SA1 - Geometrically linear Newton-Raphson	
2	Load combinations SA1 - Geometrically linear Newton-Raphson	
3	Result combinations	



Marija Gulam



Model:
diplomski_zgradaA1

Date 21.8.2024 Page 13/38
Sheet 1

MODEL

A LC2: LOADING, IN AXONOMETRIC DIRECTION

LC2 - Dodatno stalno
Loads [kN/m²]

In Axonometric Direction

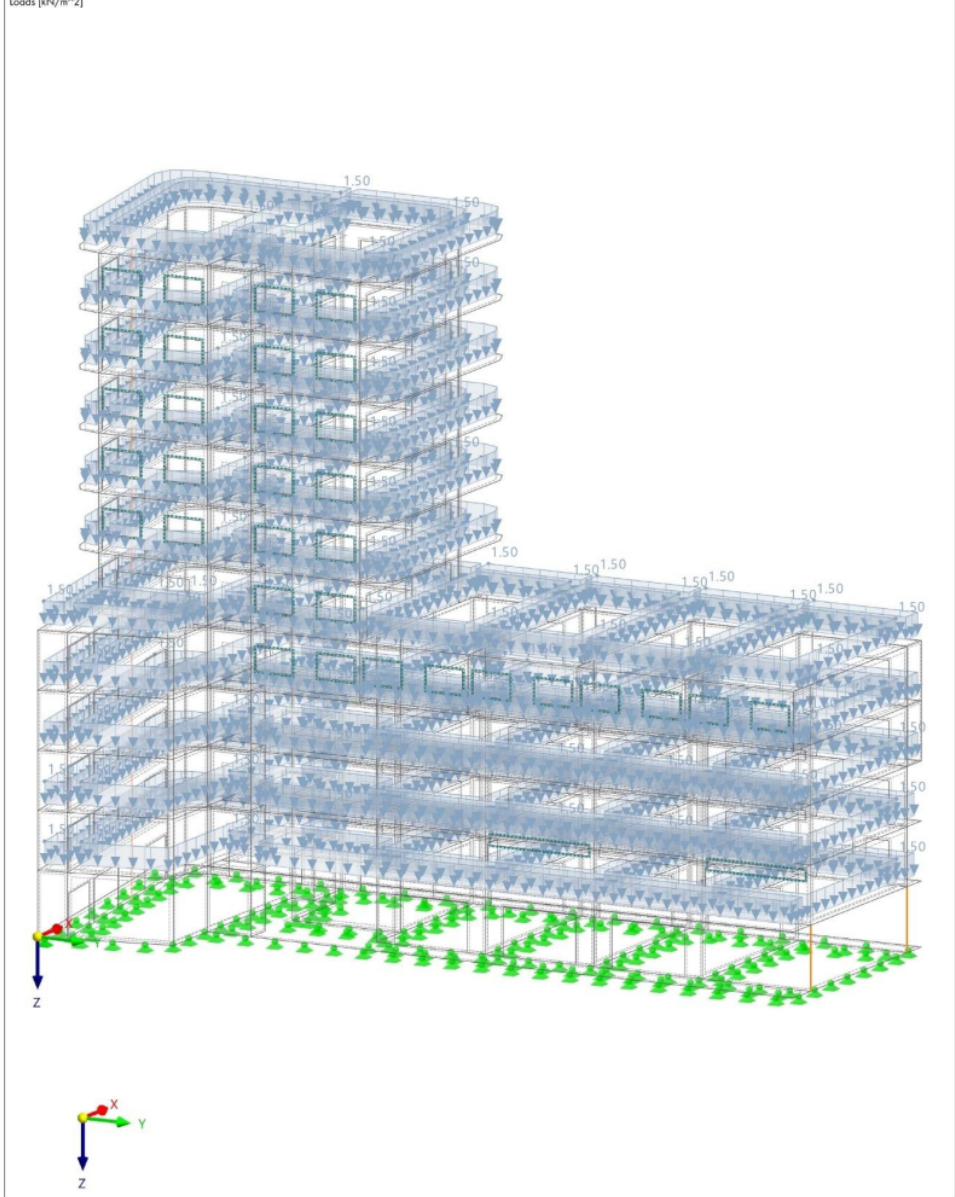

Marija Gulam



Model:
diplomski_zgradaA1

Date 21.8.2024 Page 14/38
Sheet 1

MODEL

B LC3: LOADING, IN AXONOMETRIC DIRECTION

[C3 - Uporabno
Loads [kN/m²]

In Axonometric Direction

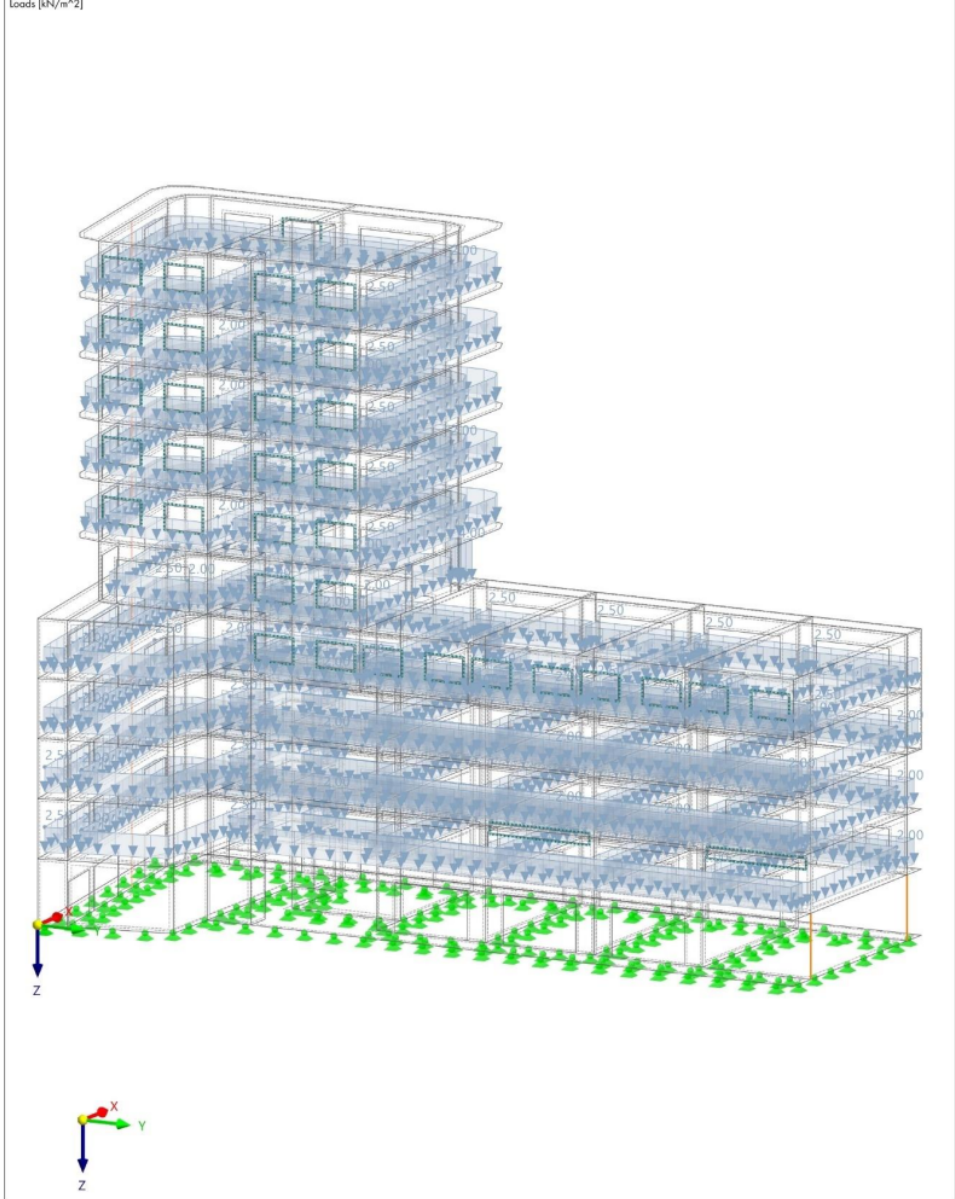

Marija Gulam



Model: diplomski_zgradaA1

Date 21.8.2024 Page 15/38
Sheet 1

MODEL

c **LCS: LOADING, IN AXONOMETRIC DIRECTION**

[LC5 - Uporabno krov
Loads [kN/m²]

In Axonometric Direction

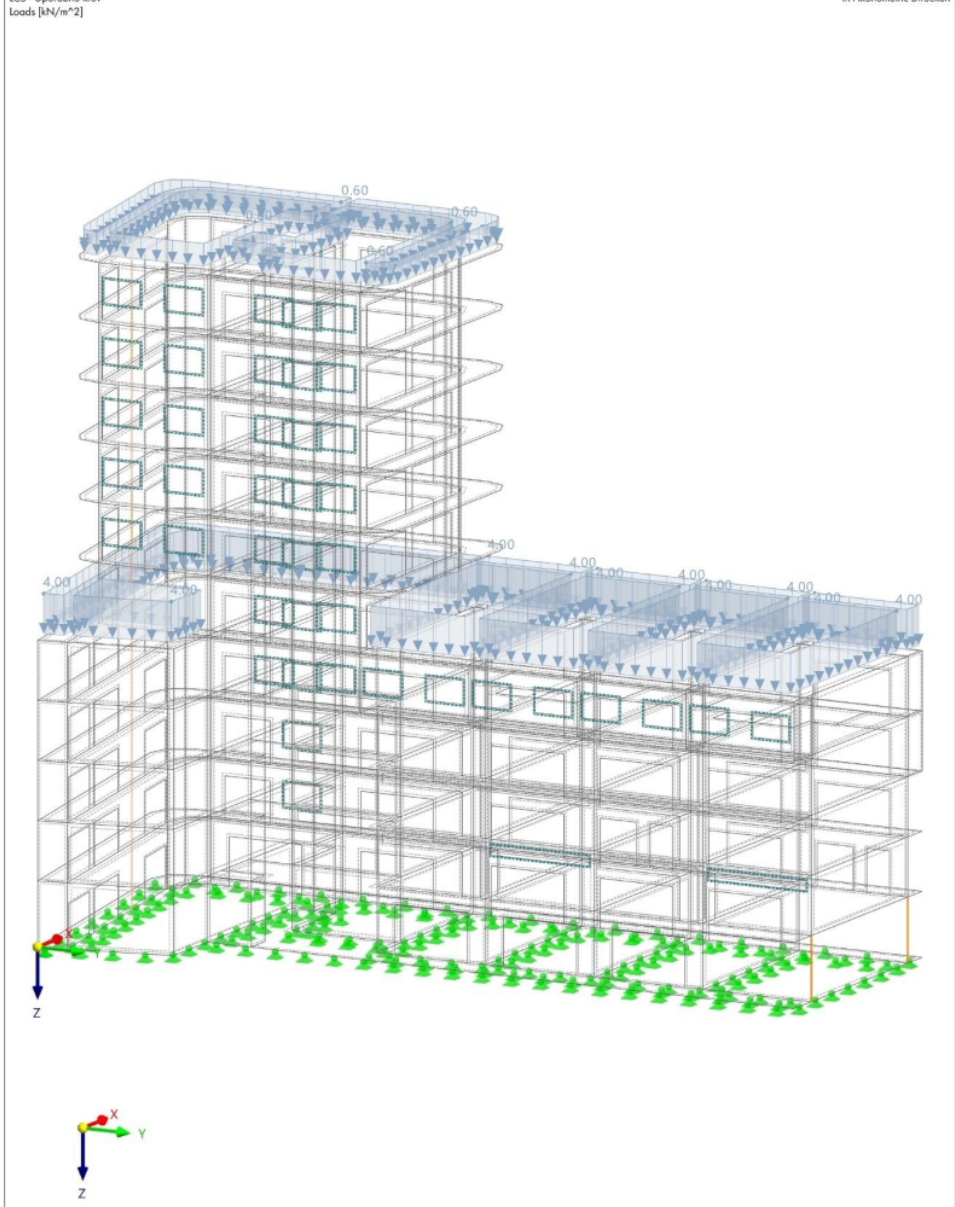

Marija Gulam



Model: diplomski_zgradaA1

Date 21.8.2024 Page 16/38
Sheet 1

MODEL

D LC4: LOADING, IN AXONOMETRIC DIRECTION

[C4 - Snijeg
Loads [kN/m²]

In Axonometric Direction

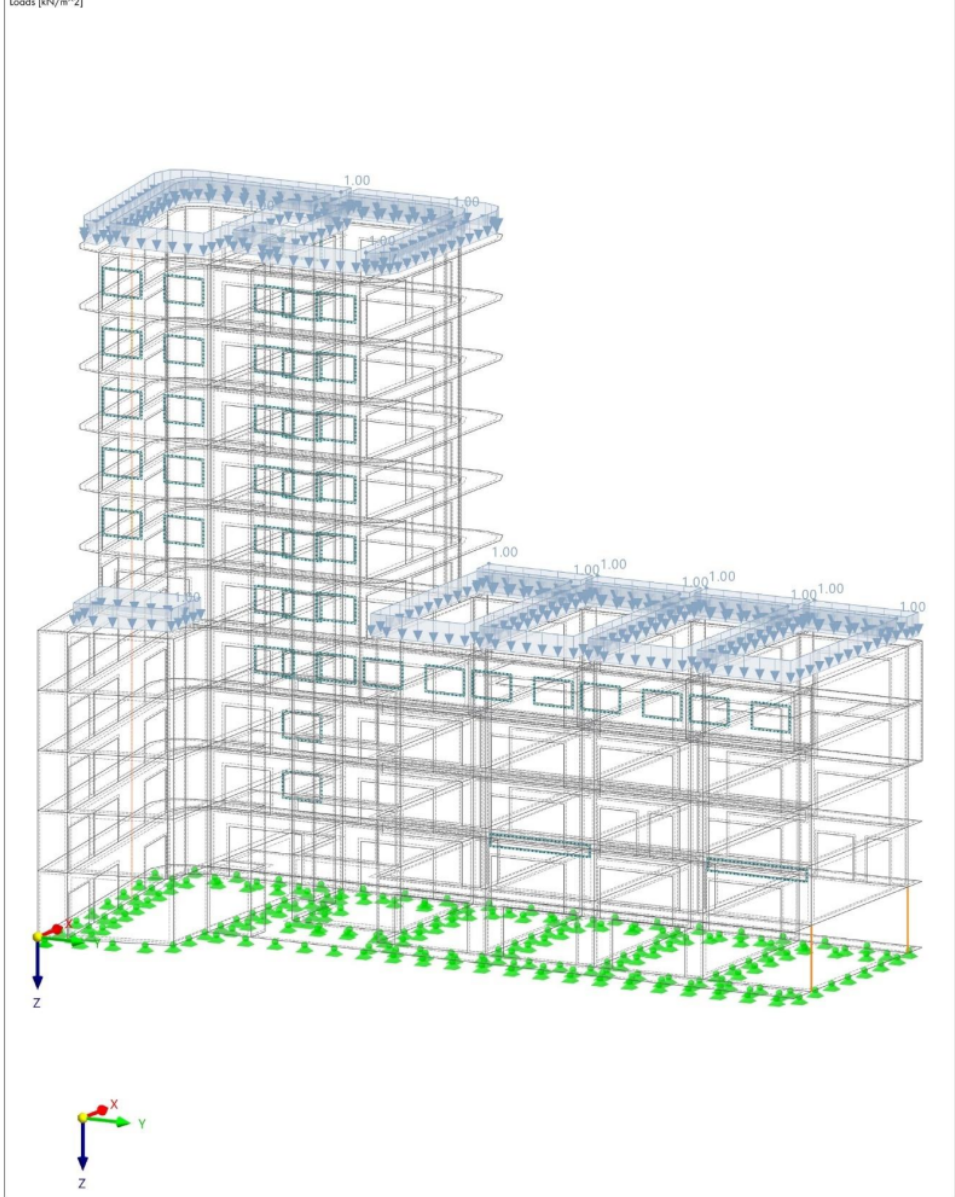

Marija Gulam



Model:
diplomski_zgradaA1

Date 21.8.2024 Page 17/38
Sheet 1

MODEL

E LC6: LOADING, IN AXONOMETRIC DIRECTION

LC6 - Vjetor
Loads [kN/m²]

In Axonometric Direction

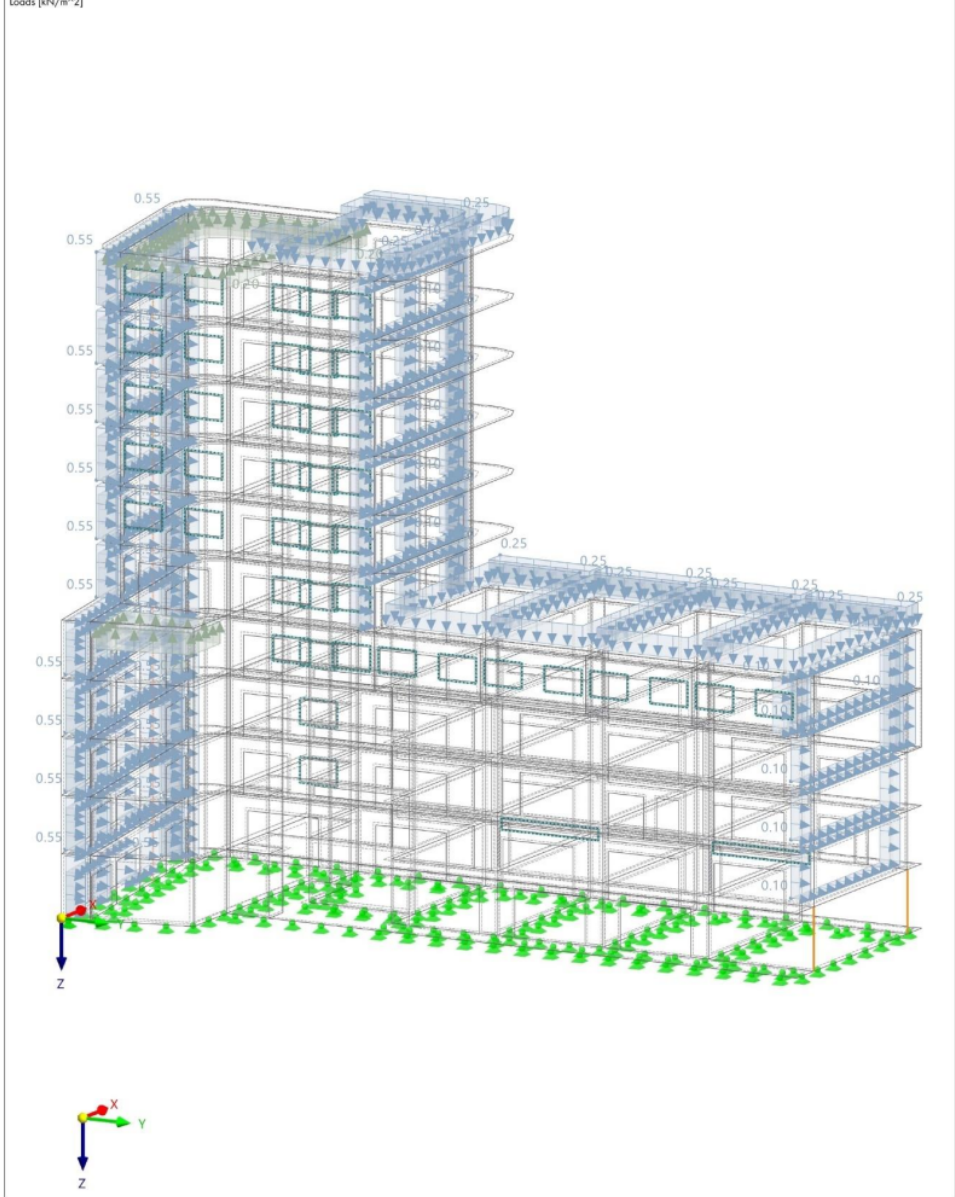

Marija Gulam



Model:
diplomski_zgradaA1

Date 21.8.2024 Page 18/38
Sheet 1

MODEL

F LC7: LOADING, IN AXONOMETRIC DIRECTION

LC7 - Vjetrov odizuci
Loads [kN/m²]

In Axonometric Direction

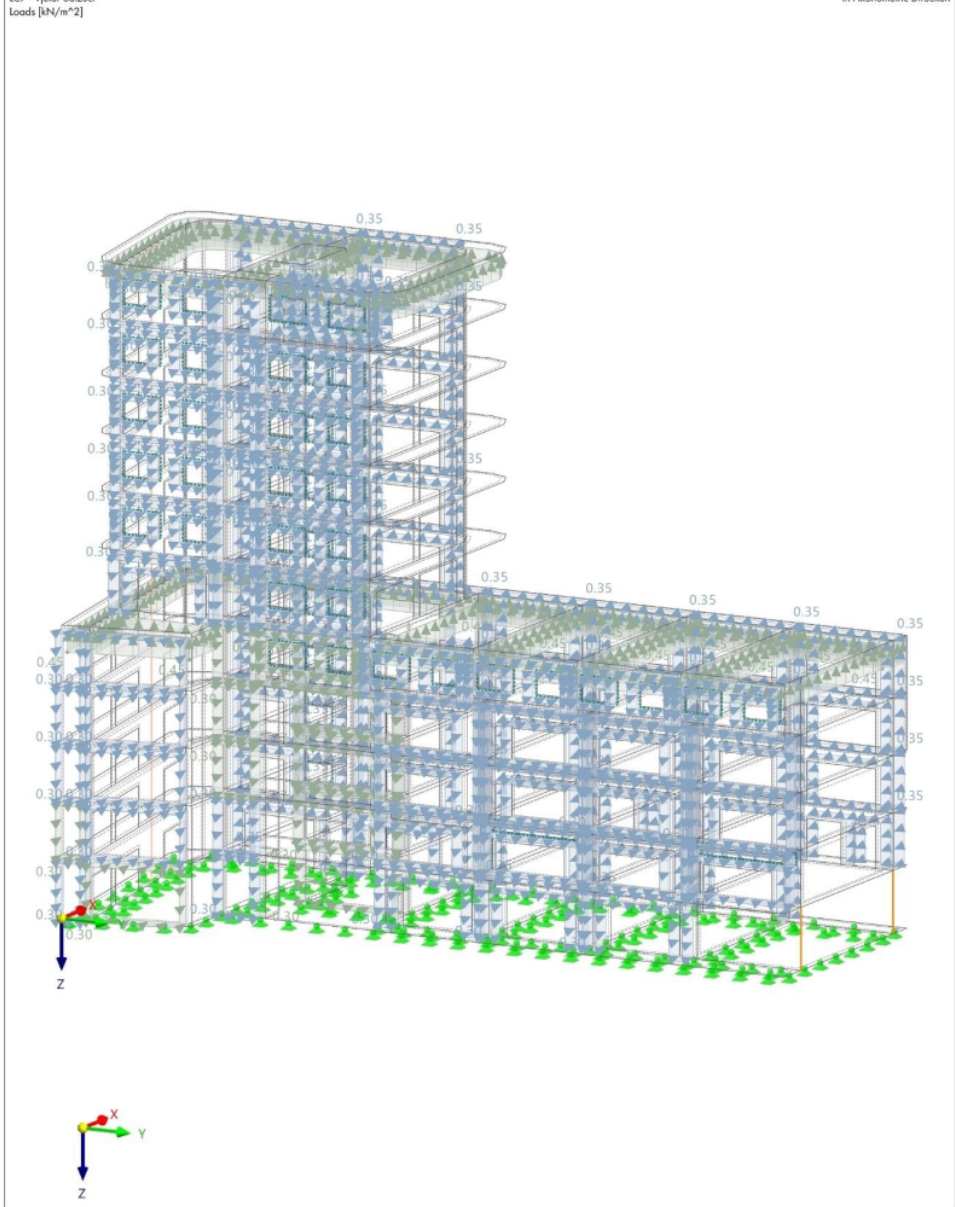



6 Dynamic Loads

6.1 RESPONSE SPECTRA

RS No.	Definition Type	Comment
1	According to Standard - EN 1998-1 HRN 2011-06	

6.1.1 RESPONSE SPECTRA - PARAMETERS

RS No.	Parameter	Symbol	Value	Unit	Reference
1	According to Standard - EN 1998-1 HRN 2011-06				
	Type of spectrum		Design Spectrum		
	Spectrum shape		Horizontal		
	Spectrum direction		A		
	Ground type				
	Earthquake action				
	Reference peak ground acceleration	a_{gR}	25.00	%	
	Importance class	γ	II		
	Design ground acceleration Horizontal	a_g	1.000	-	4.2.5(5)P
			0.250	-	
	Factors				
	Behavior factor	q	1.500	-	
	Limit value	β	0.200	-	3.2.2.2(4)P, NA.2.11
	Ground type parameters				
	Soil factor Ground type A	S	1.000	-	3.2.2.2(2)P, Tab. 3.2
	Control period Ground type A	T_B	0.150	s	3.2.2.2(2)P, Tab. 3.2
	Control period Ground type A	T_C	0.400	s	3.2.2.2(2)P, Tab. 3.2
	Control period Ground type A	T_D	2.000	s	3.2.2.2(2)P, Tab. 3.2
	Maximum period	T_{max}	4.000	s	

6.2 RESPONSE SPECTRA | DIAGRAM

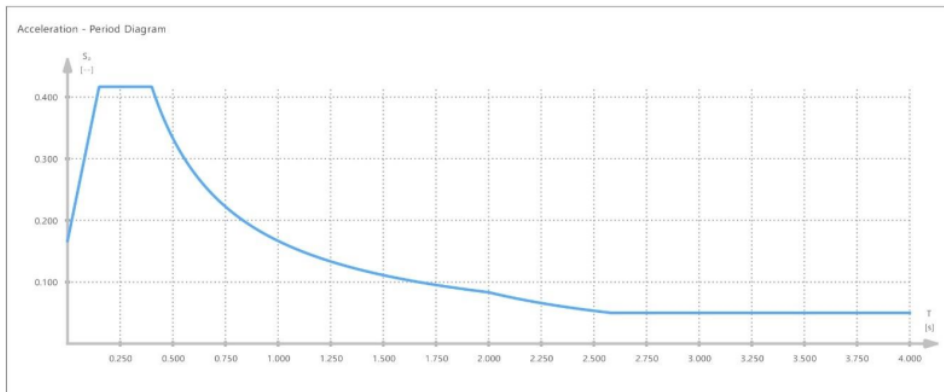

7 Static Analysis Results



Marija Gulam



Model:
diplomski_zgradaA1

Date 21.8.2024 Page 20/38
Sheet 1

MODEL

7.1 CO10: BASIC INTERNAL FORCES M_x IN AXONOMETRIC DIRECTION

Static Analysis

CO10 - 1.35 * IC1 + 1.35 * IC2 + 1.50 * IC3 + 1.50 * IC5 + 0.75 * IC4 + 0.90 * IC6
Static Analysis
Moments m_x [kNm/m]

In Axonometric Direction

Surfaces Internal Forces Basic Internal Forces m_x [kNm/m]	
47.798	0.00 %
39.709	0.00 %
31.620	0.23 %
23.531	1.69 %
15.442	9.45 %
7.353	60.67 %
-0.736	20.99 %
-8.825	4.84 %
-16.914	1.57 %
-25.003	0.51 %
-33.092	0.05 %
-41.181	

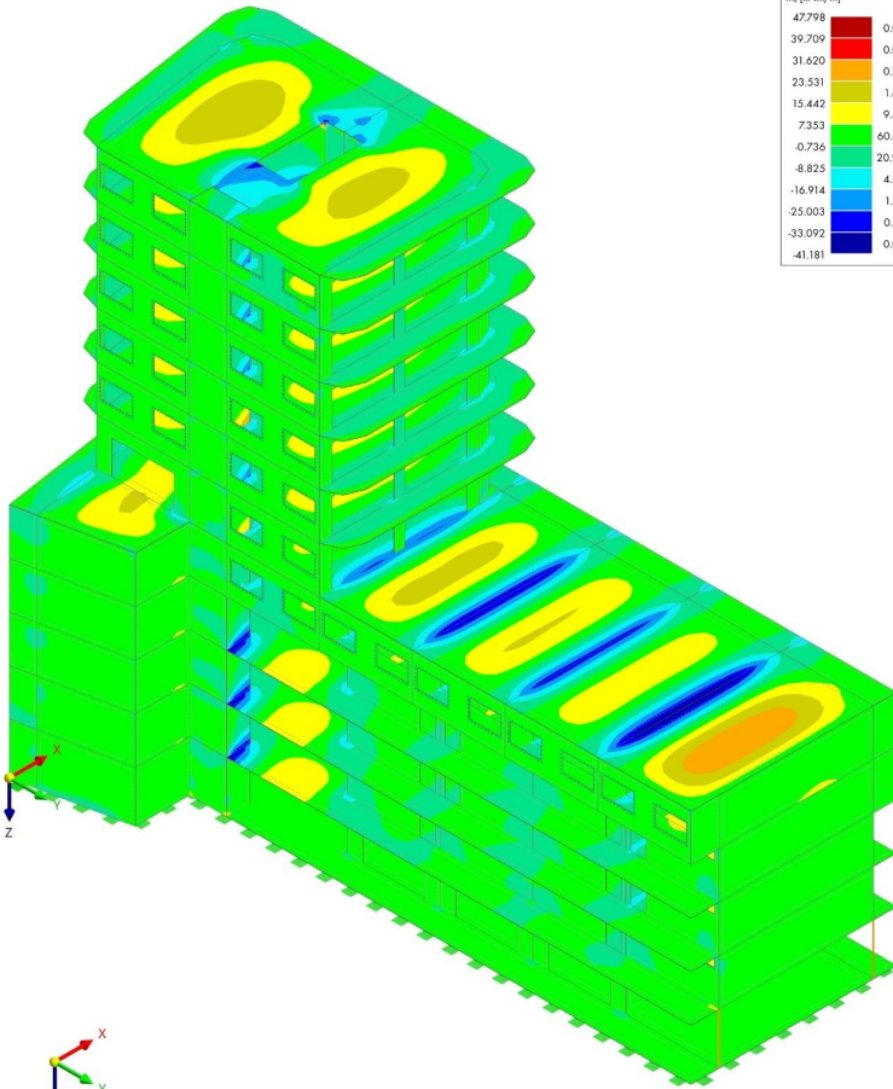

max m_x : 47.798 | min m_x : -41.181 kNm/m



Marija Gulam



Model:
diplomski_zgradaA1

Date 21.8.2024 Page 21/38
Sheet 1

MODEL

7.2 CO10: BASIC INTERNAL FORCES M_y , IN AXONOMETRIC DIRECTION

Static Analysis

CO10 - 1.35 * IC1 + 1.35 * IC2 + 1.50 * IC3 + 1.50 * IC5 + 0.75 * IC4 + 0.90 * IC6
Static Analysis
Moments m_y [kNm/m]

In Axonometric Direction

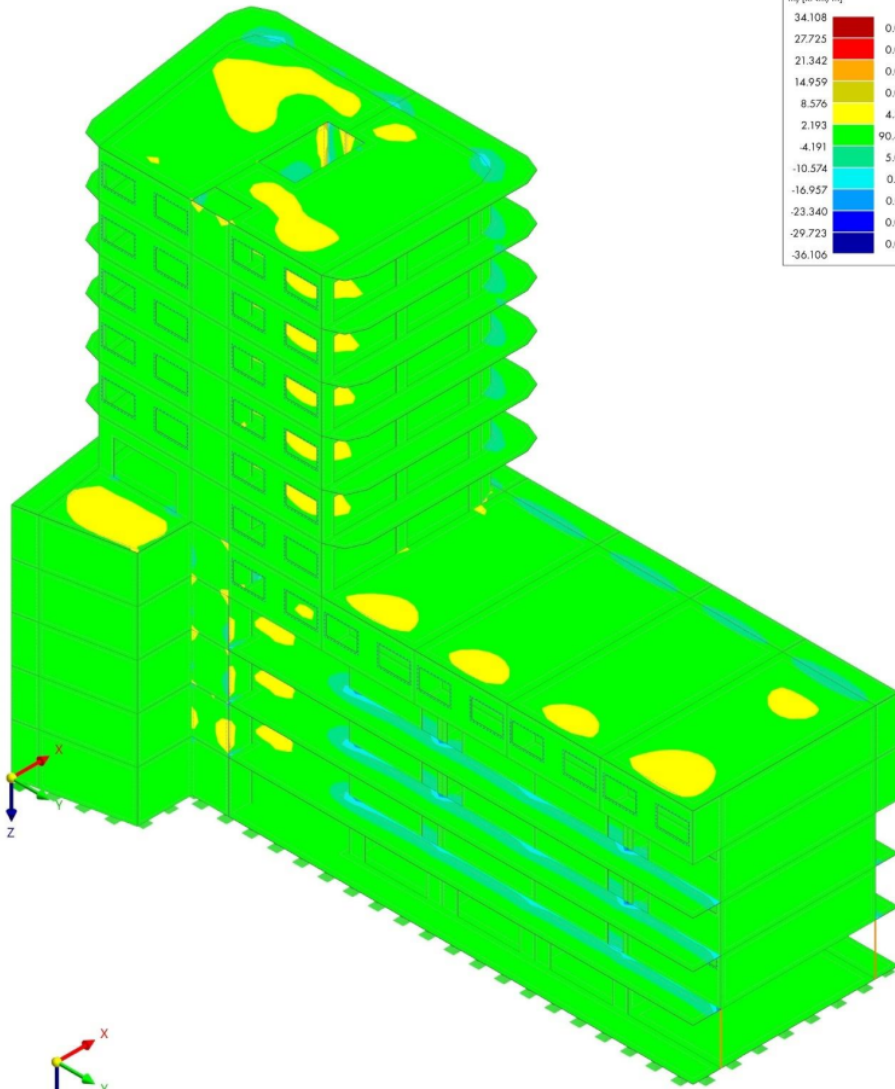

max m_y : 34.108 | min m_y : -36.106 kNm/m



Marija Gulam



Model:
diplomski_zgradaA1

Date 21.8.2024 Page 22/38
Sheet 1

MODEL

7.3 CO10: BASIC INTERNAL FORCES N_x IN AXONOMETRIC DIRECTION

Static Analysis

CO10 - 1.35 * IC1 + 1.35 * IC2 + 1.50 * IC3 + 1.50 * IC5 + 0.75 * IC4 + 0.90 * IC6
Static Analysis
Axial Forces n_x [kN/m]

In Axonometric Direction

Surfaces Internal Forces Basic Internal Forces n_x [kN/m]	Percentage
522.195	0.00 %
293.161	0.20 %
64.127	84.03 %
-164.907	11.11 %
-393.941	4.26 %
-622.975	0.38 %
-852.009	0.02 %
-1081.040	0.00 %
-1310.080	0.00 %
-1539.110	0.00 %
-1768.140	0.00 %
-1997.180	0.00 %

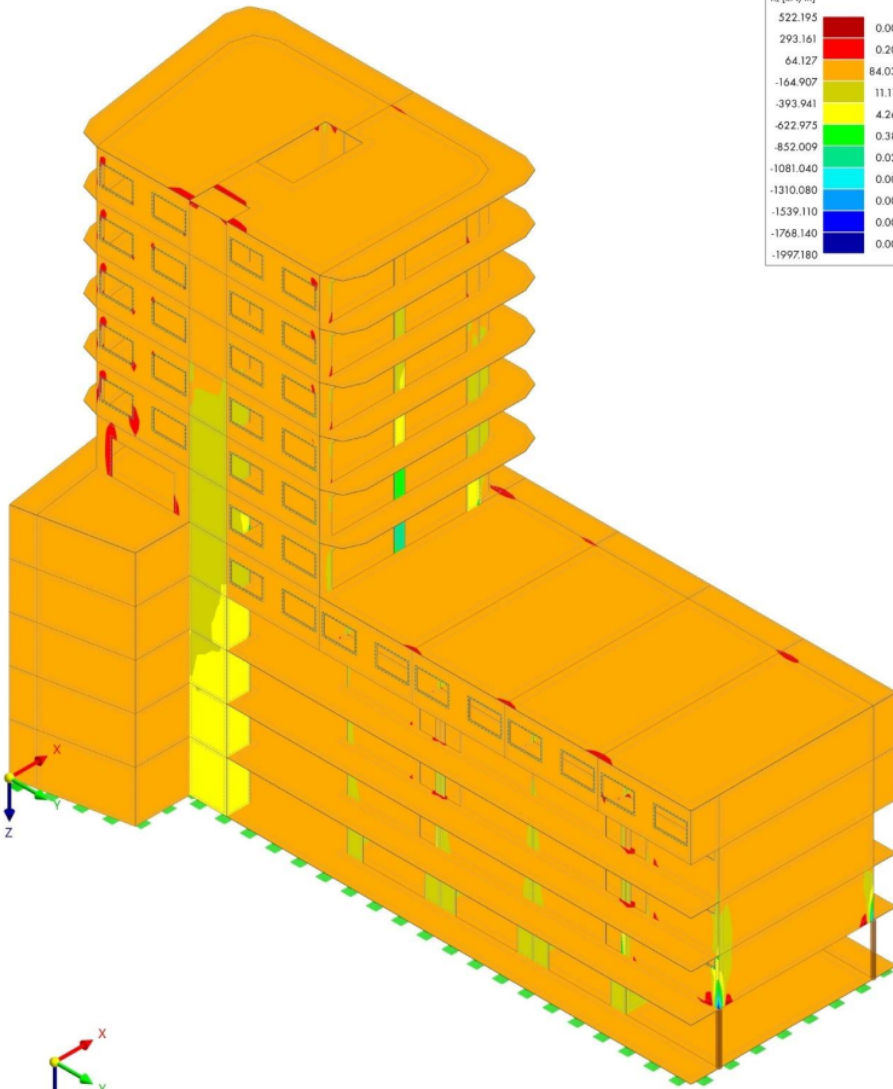

max n_x : 522.195 | min n_x : -1997.180 kN/m



Marija Gulam



Model: diplomski_zgradaA1

Date 21.8.2024 Page 23/38
Sheet 1

MODEL

7.4 CO10: BASIC INTERNAL FORCES N_y , IN AXONOMETRIC DIRECTION

Static Analysis

CO10 - 1.35 * IC1 + 1.35 * IC2 + 1.50 * IC3 + 1.50 * IC5 + 0.75 * IC4 + 0.90 * IC6
Static Analysis
Axial Forces n_y [kN/m]

In Axonometric Direction

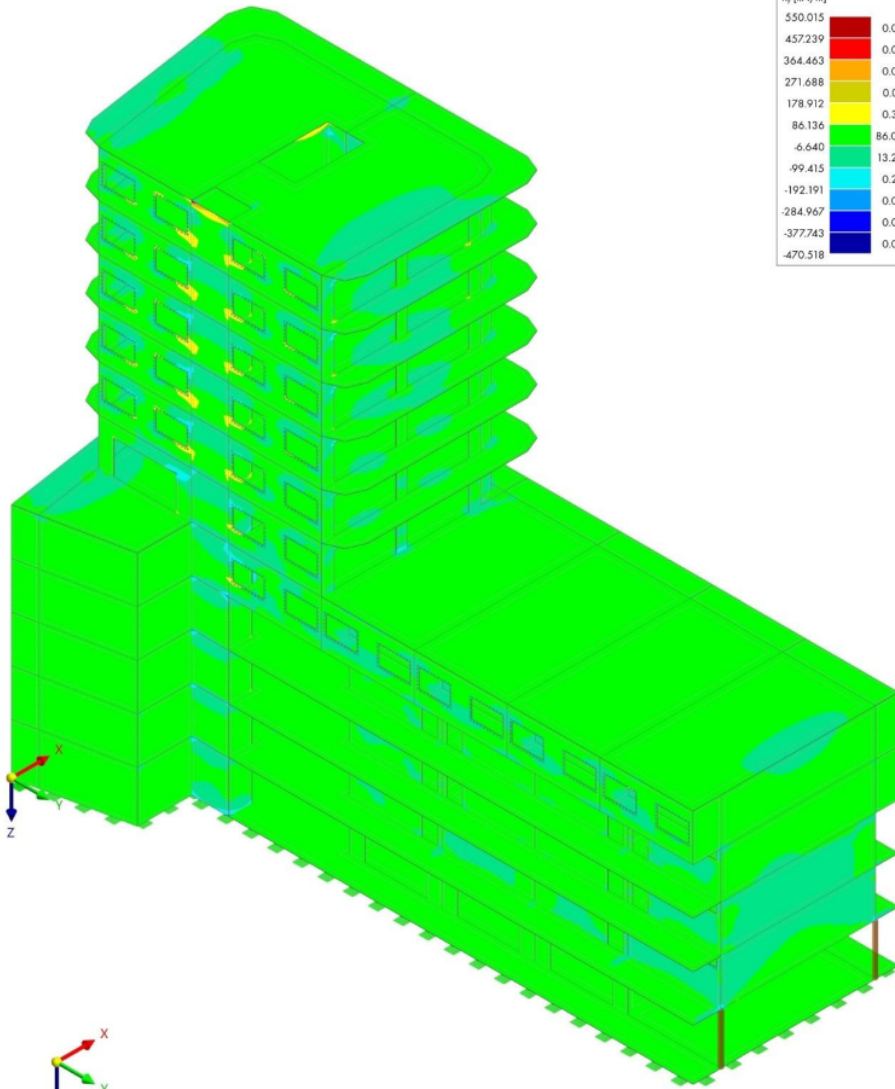

max n_y : 550.015 | min n_y : -470.518 kN/m



Marija Gulam



Model: diplomski_zgradaA1

Date 21.8.2024 Page 24/38
Sheet 1

MODEL

7.5 COS7: GLOBAL DEFORMATIONS |U|, IN AXONOMETRIC DIRECTION

Static Analysis

COS7 - IC1 + IC2 + IC3 + IC5 + 0.50 * IC4 + 0.60 * IC6
Static Analysis
Displacements |u| [mm]

In Axonometric Direction

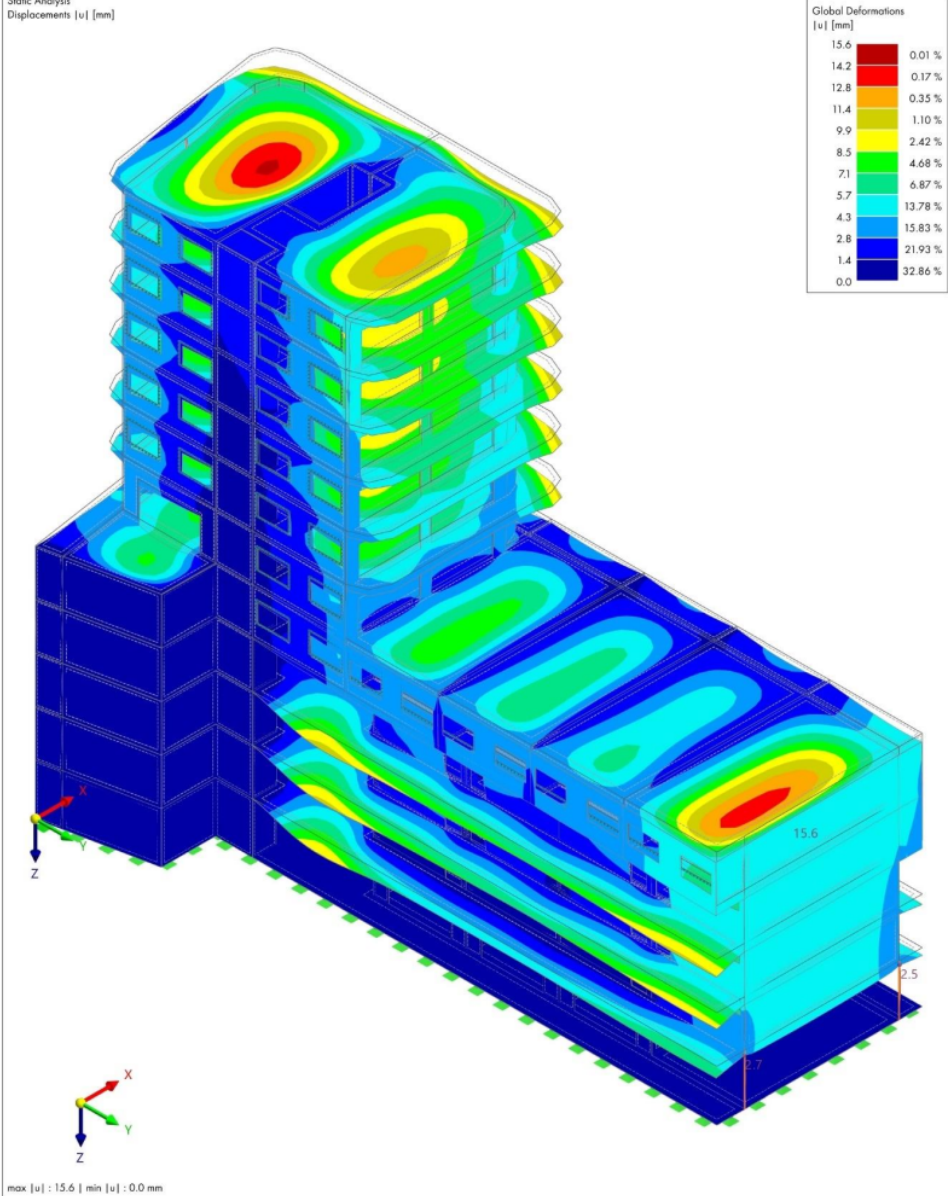

Marija Gulam



Model: diplomski_zgradaA1

Date 21.8.2024 Page 25/38
Sheet 1

MODEL

7.6 CO104: GLOBAL DEFORMATIONS |U|, IN AXONOMETRIC DIRECTION

Static Analysis

CO104 - 1.60 * IC1 + 1.60 * IC2 + 1.18 * IC3 + 1.18 * IC5 + 0.50 * IC4 + 0.60 * IC6
Static Analysis
Displacements |u| [mm]

In Axonometric Direction

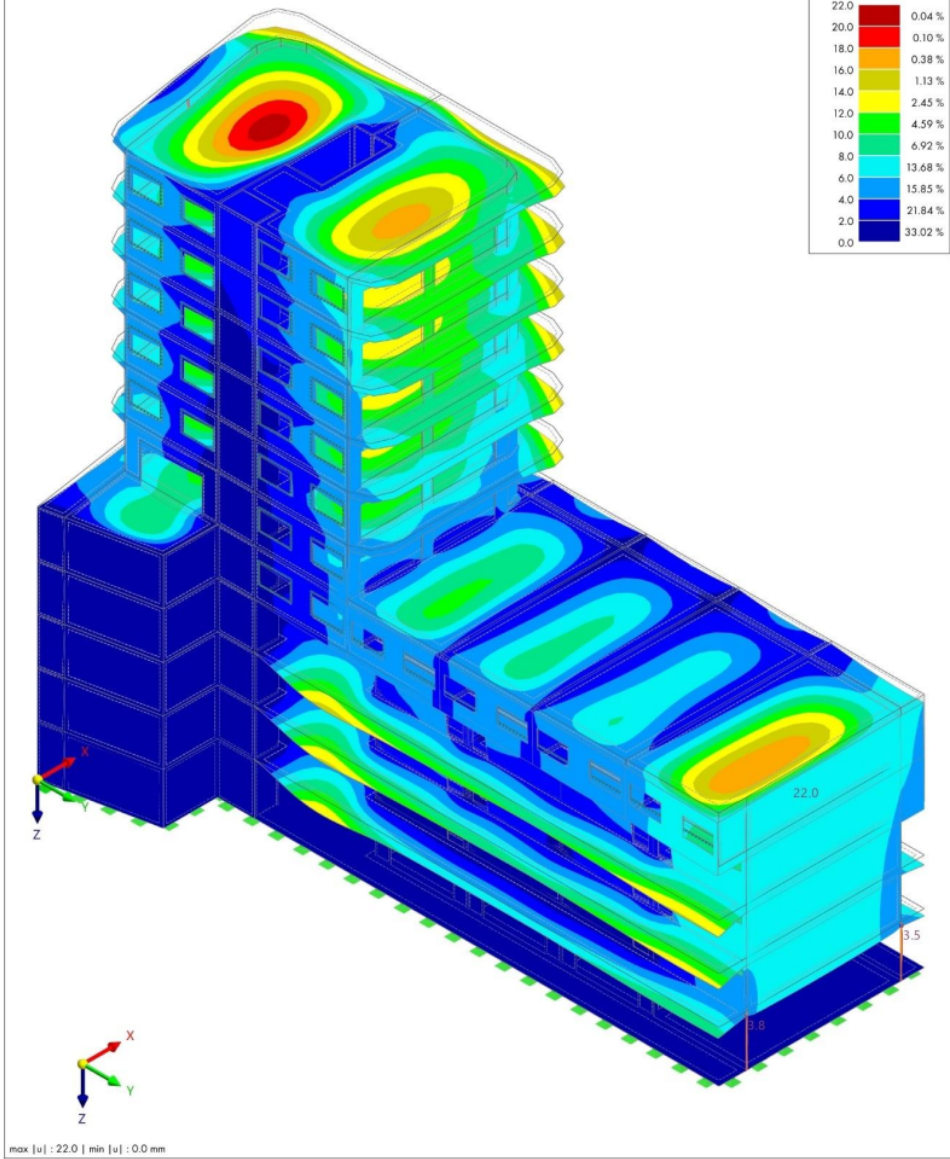

Marija Gulam



Model: diplomski_zgradaA1

Date 21.8.2024 Page 26/38
Sheet 1

MODEL

7.7 CO10: FORCES N, IN AXONOMETRIC DIRECTION

Static Analysis

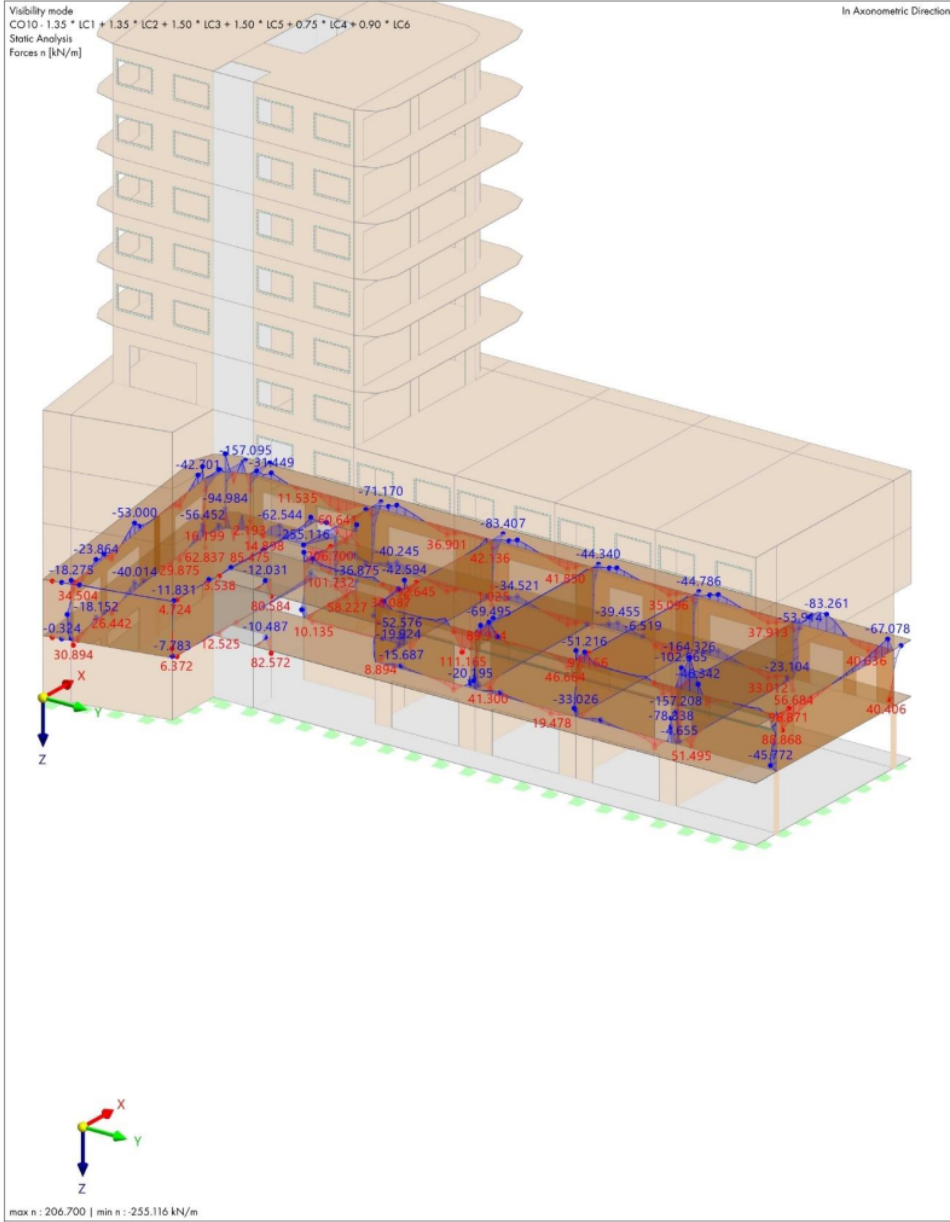

Marija Gulam



Model: diplomski_zgradaA1

Date 21.8.2024 Page 27/38
Sheet 1

MODEL

7.8 CO10: FORCES V_{yy} IN AXONOMETRIC DIRECTION

Static Analysis

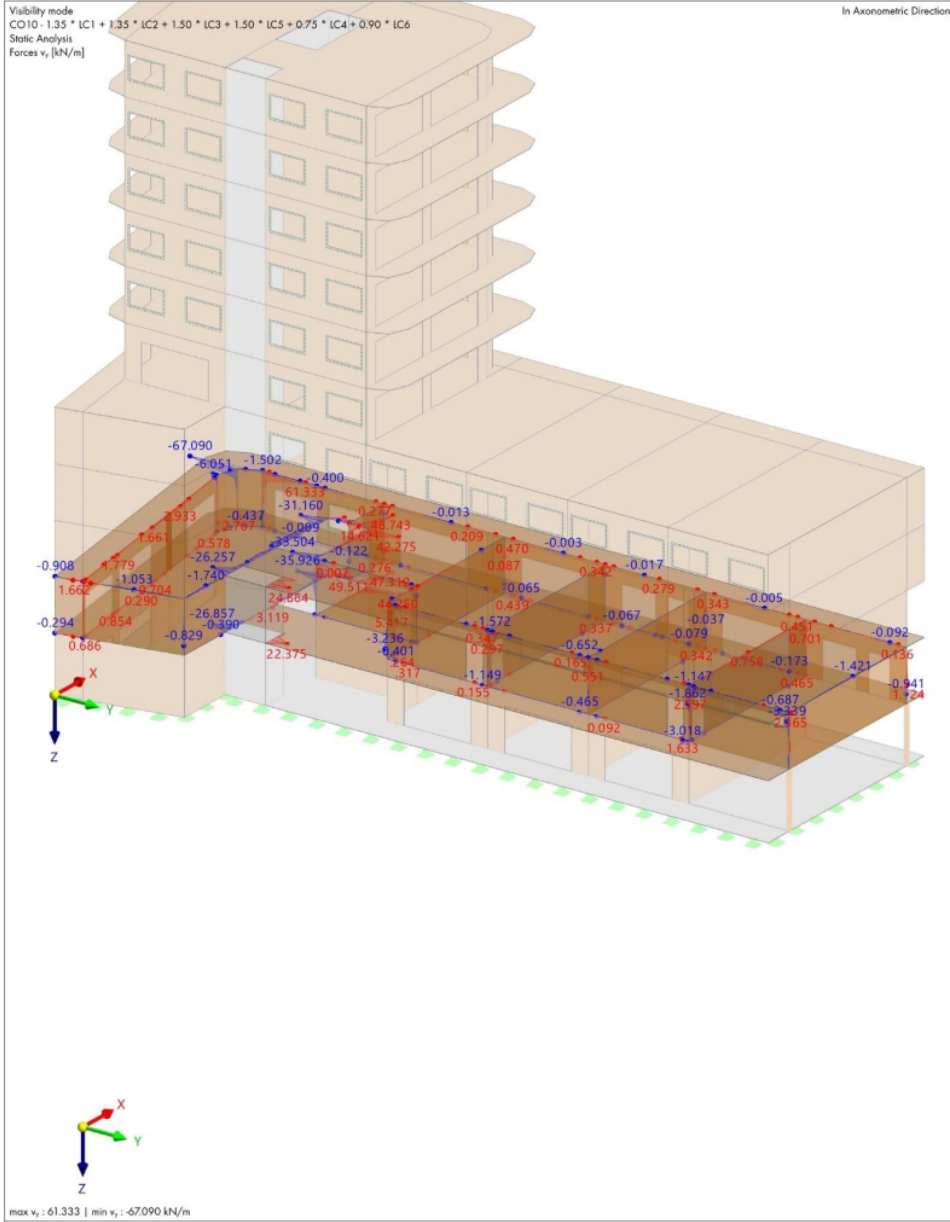

Marija Gulam



Model: diplomski_zgradaA1

Date 21.8.2024 Page 28/38
Sheet 1

MODEL

7.9 CO10: FORCES V_z IN AXONOMETRIC DIRECTION

Static Analysis

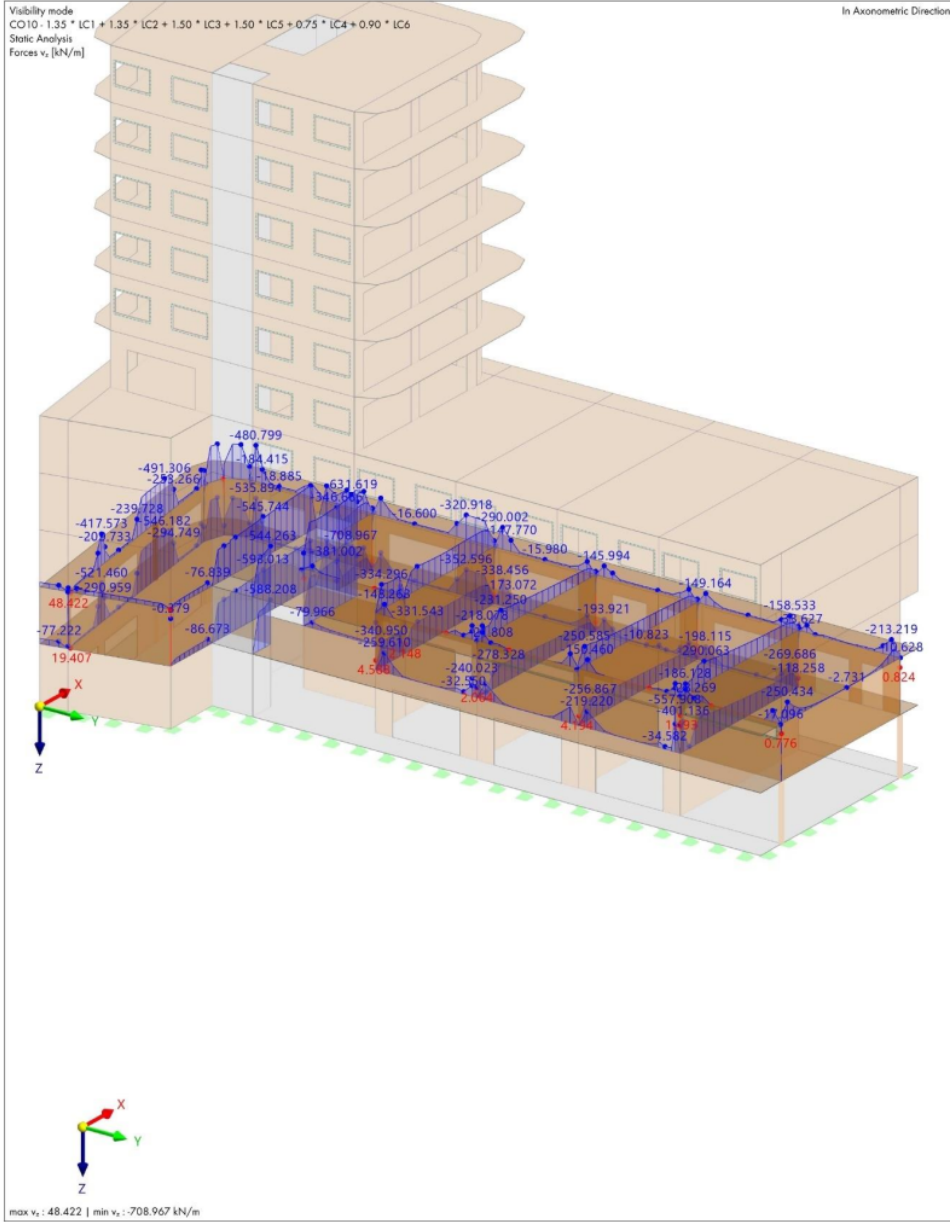

Marija Gulam



Model: diplomski_zgradaA1

Date 21.8.2024 Page 29/38
Sheet 1

MODEL

8 Modal Analysis Results

8.1 NATURAL FREQUENCIES

Modal Analysis

Mode No.	Eigenvalue λ [1/s ²]	Angular Frequency ω [rad/s]	Natural Frequency f [Hz]	Natural Period T [s]
1	103.124	10.155	1.616	0.619
2	321.642	17.934	2.854	0.350
3	409.372	20.233	3.220	0.311
4	729.392	27.007	4.298	0.233
5	952.937	30.870	4.913	0.204
6	3575.427	59.795	9.517	0.105
7	3802.785	61.667	9.815	0.102
8	4072.037	63.813	10.156	0.098
9	4648.098	68.177	10.851	0.092
10		68.274	10.866	0.092
11	5454.337	73.853	11.754	0.085
12	6210.160	78.805	12.542	0.080
13	6475.025	80.468	12.807	0.078
14	8982.998	94.779	15.084	0.066
15	9656.753	98.269	15.640	0.064
16	9772.166	98.854	15.733	0.064
17	9828.970	99.141	15.779	0.063
18	10015.143	100.076	15.928	0.063
19	10097.476	100.486	15.993	0.063
20	10136.179	100.679	16.023	0.062
21	10267.466	101.329	16.127	0.062
22	10292.320	101.451	16.146	0.062
23	10340.744	101.689	16.184	0.062
24	10379.716	101.881	16.215	0.062
25	10436.674	102.155	16.258	0.062
26	10867.221	104.246	16.591	0.060
27	11256.549		16.886	0.059
28	11577.141	107.597	17.125	0.058
29	11756.188	108.426	17.257	0.058
30	11807.545	108.663	17.294	0.058

8.2 EFFECTIVE MODAL MASSES

Modal Analysis

Mode No.	Modal Mass m_k [kg]	Transl. Eff. Modal Mass [kg]			Rotat. Eff. Modal Mass [kgm ²]			Transl. Eff. Modal Mass Factor [-]			Rotat. Eff. Modal Mass Factor [-]		
		m_{kx}	m_{ky}	m_{kz}	m_{kpx}	m_{kpy}	m_{kpz}	f_{m1x}	f_{m1y}	f_{m1z}	f_{m2x}	f_{m2y}	f_{m2z}
1	316378.9	1336.1	1005270.0	0.0	52761200.00	51276.40	274059.00	0.001	0.604	0.000	0.387	0.000	0.001
2	82587.3	418950.0	8762.7	0.0	111940.0	17078900.0	14488000.00	0.252	0.005	0.000	0.001	0.125	0.065
3	120905.4	365356.0	609.8	0.0	64.35	47168200.00	98728900.00	0.219	0.000	0.000	0.000	0.346	0.441
4	143194.8	383436.0	7860.8	0.0	764782.00	3538420.00	72057400.00	0.230	0.005	0.000	0.006	0.026	0.322
5	375549.1	11697.9	397696.0	0.0	41454100.00	303596.00	518269.00	0.007	0.239	0.000	0.304	0.002	0.002
6	103675.1	46436.8	6618.2	0.0	989067.00	2248110.00	4860260.00	0.028	0.004	0.000	0.007	0.016	0.022
7	125540.5	186207.0	26947.5	0.0	3534620.00	18894700.00	7661600.00	0.112	0.016	0.000	0.026	0.138	0.034
8	23364.8	11328.8	85640.5	0.0	13455300.00	1821250.00	849609.00	0.007	0.051	0.000	0.099	0.013	0.004
9	278.5	398.8	2370.2	0.0	387370.00	34549.10	60415.90	0.000	0.001	0.000	0.003	0.000	0.000
10	283.0	319.3	3381.8	0.0	558707.00	30730.50	57596.90	0.000	0.002	0.000	0.004	0.000	0.000
11	17276.9	49974.1	166.7	0.0	27668.50	12915000.00	11606500.00	0.030	0.000	0.000	0.000	0.095	0.052
12	90525.9	613.9	25517.4	0.0	4587500.00	15879.80	1049730.00	0.000	0.015	0.000	0.034	0.000	0.005
13	55405.2	973.0	8881.5	0.0	1889720.00	75071.60	554114.00	0.001	0.005	0.000	0.014	0.001	0.002
14	16015.8	3211.0	245.3	0.0	13499.60	1111180.00	267165.00	0.002	0.000	0.000	0.000	0.008	0.001
15	579.8	8676.9	1332.5	0.0	214291.00	1562450.00	4.73	0.005	0.001	0.000	0.002	0.011	0.000
16	167.6	1595.9	1763.1	0.0	295745.00	274288.00	3649.17	0.001	0.001	0.000	0.002	0.002	0.000
17	176.6	165.8	3704.6	0.0	607526.00	16289.50	134208.00	0.000	0.002	0.000	0.004	0.000	0.001
18	447.1	294.5	21014.8	0.0	3488300.00	81232.10	3990.17	0.000	0.013	0.000	0.028	0.001	0.000
19	166.8	473.8	1303.6	0.0	219574.00	75511.50	1697.26	0.000	0.001	0.000	0.002	0.001	0.000
20	247.7	60.3	191.2	0.0	32800.30	9081.35	4442.17	0.000	0.000	0.000	0.000	0.000	0.000
21	169.9	32.1	139.5	0.0	26240.20	5198.96	3194.29	0.000	0.000	0.000	0.000	0.000	0.000
22	254.3	240.9	342.9	0.0	55028.60	32097.60	237.36	0.000	0.000	0.000	0.000	0.000	0.000
23	186.4	0.3	354.7	0.0	54342.90	690.66	1193.73	0.000	0.000	0.000	0.000	0.000	0.000
24	285.3	0.1	1219.0	0.0	209384.00	1061.15	17.38	0.000	0.001	0.000	0.002	0.000	0.000
25	221.7	199.5	1.7	0.0	462.87	32697.10	2374.39	0.000	0.000	0.000	0.000	0.000	0.000
26	206.6	6635.4	135.3	0.0	27974.20	1307530.00	22723.80	0.004	0.000	0.000	0.000	0.010	0.000
27	430.7	22164.0	760.4	0.0	143790.00	3470840.00	407931.00	0.013	0.000	0.000	0.001	0.025	0.002
28	297.2	14567.7	24.5	0.0	3728.58	2042270.00	1473200.00	0.009	0.000	0.000	0.000	0.015	0.007
29	195.4	1839.4	68.1	0.0	12834.50	210893.00	448136.00	0.001	0.000	0.000	0.000	0.002	0.002
30	157.6	3831.4	6.3	0.0	1594.97	531292.00	309477.00	0.002	0.000	0.000	0.000	0.004	0.001
Σ	1475172.0	1541020.0	1612340.0	0.0	1.26e+08	1.15e+08	2.16e+08	0.925	0.968	0.000	0.923	0.842	0.963
Σ_{M1}		1665500.0	1665500.0	0.0	1.37e+08	1.37e+08	2.24e+08						
%		92.53 %	96.81 %		92.25 %	84.20 %	96.33 %						



Marija Gulam



Model:
diplomski_zgradaA1

Date 21.8.2024 Page 30/38
Sheet 1

RESULTS

8.3 EFFECTIVE MODAL MASSES - EQUIVALENT MASS PER UNIT LENGTH

Modal Analysis

Mode No.	Modal Mass M [kg]
1	316378.9
2	82587.3
3	120905.4
4	143194.8
5	375549.1
6	103675.1
7	125540.5
8	23364.8
9	278.5
10	283.0
11	17276.9
12	90525.9
13	55405.2
14	16015.8
15	579.8
16	167.6
17	176.6
18	447.1
19	166.8
20	247.7
21	169.9
22	254.3
23	186.4
24	285.3
25	221.7
26	206.6
27	430.7
28	297.2
29	195.4
30	157.6
Σ	1475172.0
%	



Marija Gulam



Model: diplomski_zgradaA1

Date 21.8.2024 Page 31/38
Sheet 1

MODEL

8.4 **LC9: MODE SHAPE |U|, IN AXONOMETRIC DIRECTION**

Modal Analysis

LC9 - Potres_modalna
Modal Analysis
Mode No. 1 - 1.616 Hz
Normalized Displacements |u|

In Axonometric Direction

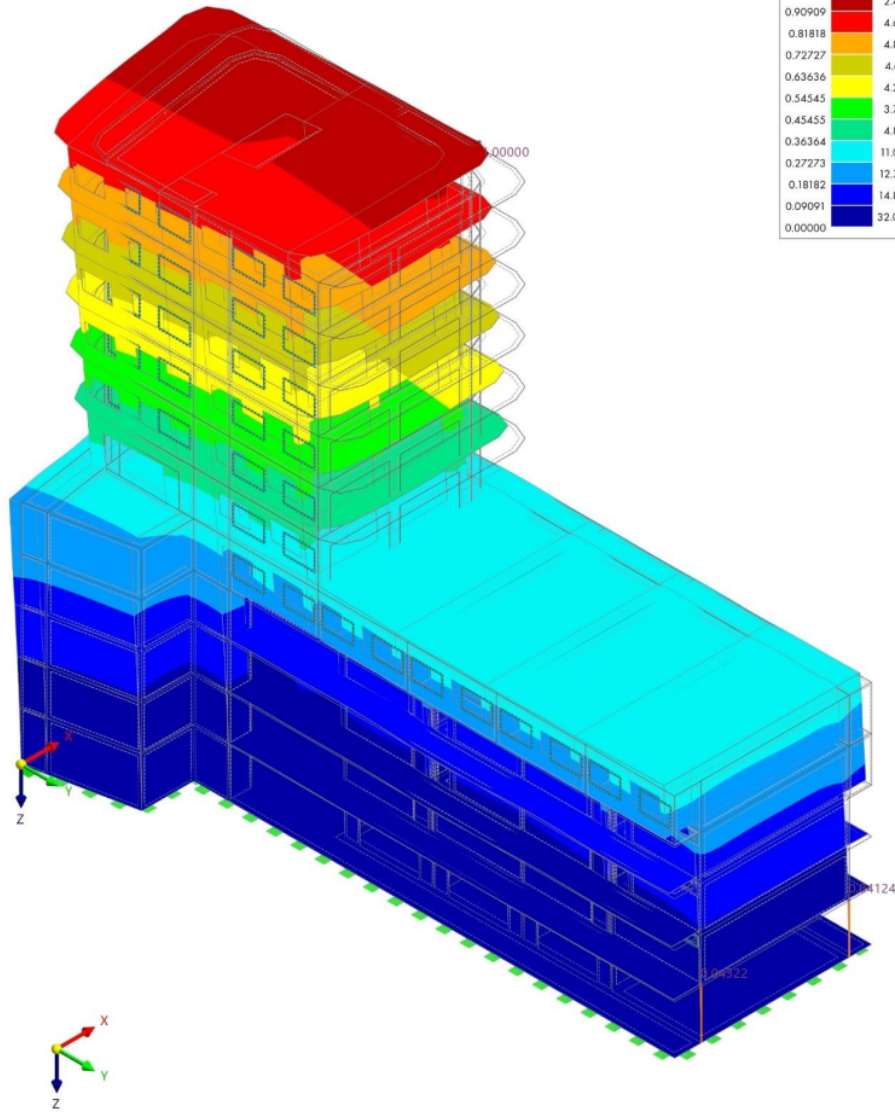

max |u| : 1.00000 | min |u| : 0.00000



Marija Gulam



Model:
diplomski_zgradaA1

Date 21.8.2024 Page 32/38
Sheet 1

MODEL

8.5 LC9: MODE SHAPE |U|, IN AXONOMETRIC DIRECTION

Modal Analysis

LC9 - Potres_modalna
Modal Analysis
Mode No. 2 - 2.854 Hz
Normalized Displacements |u|

In Axonometric Direction

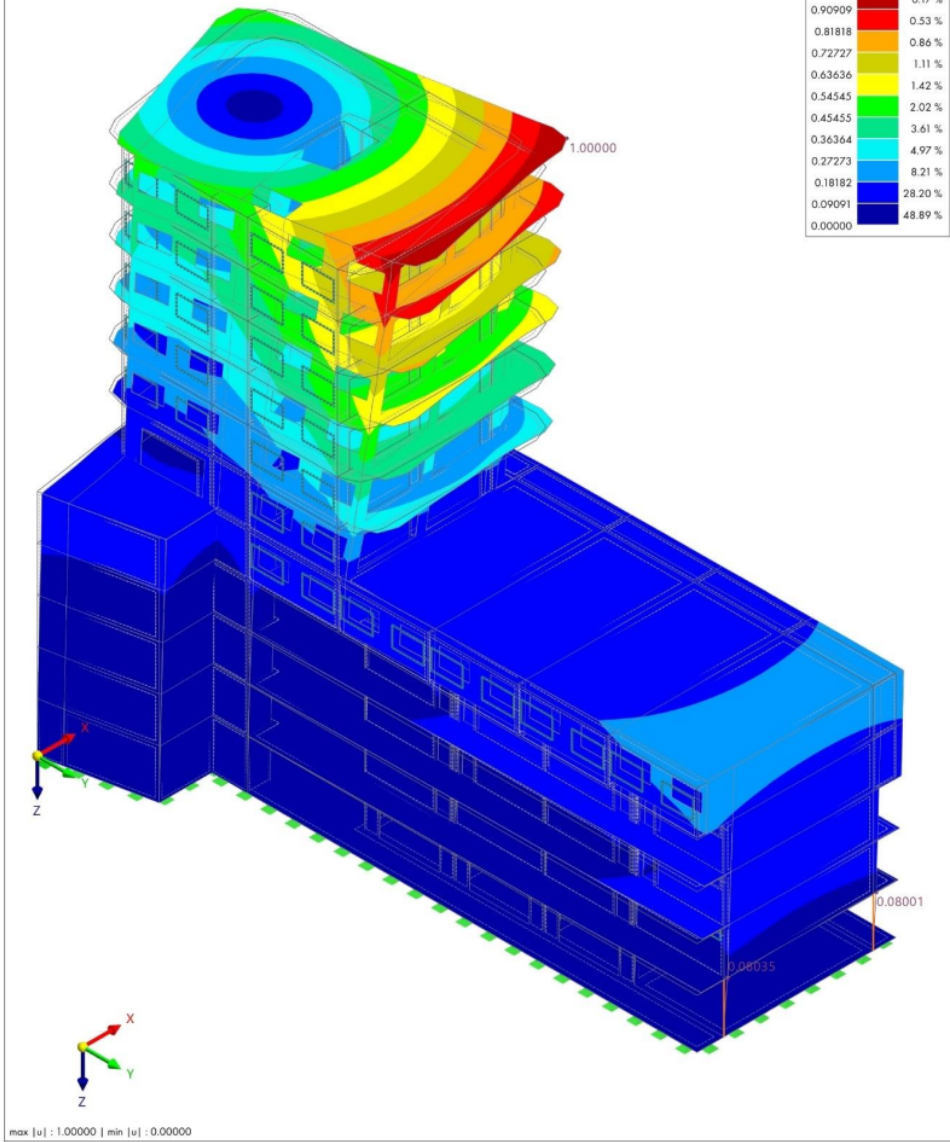

Marija Gulam



Model: diplomski_zgradaA1

Date 21.8.2024 Page 33/38
Sheet 1

MODEL

8.6 LC9: MODE SHAPE |U|, IN AXONOMETRIC DIRECTION

Modal Analysis

LC9 - Potres_modalna
Modal Analysis
Mode No. 3 - 3.220 Hz
Normalized Displacements |u|

In Axonometric Direction

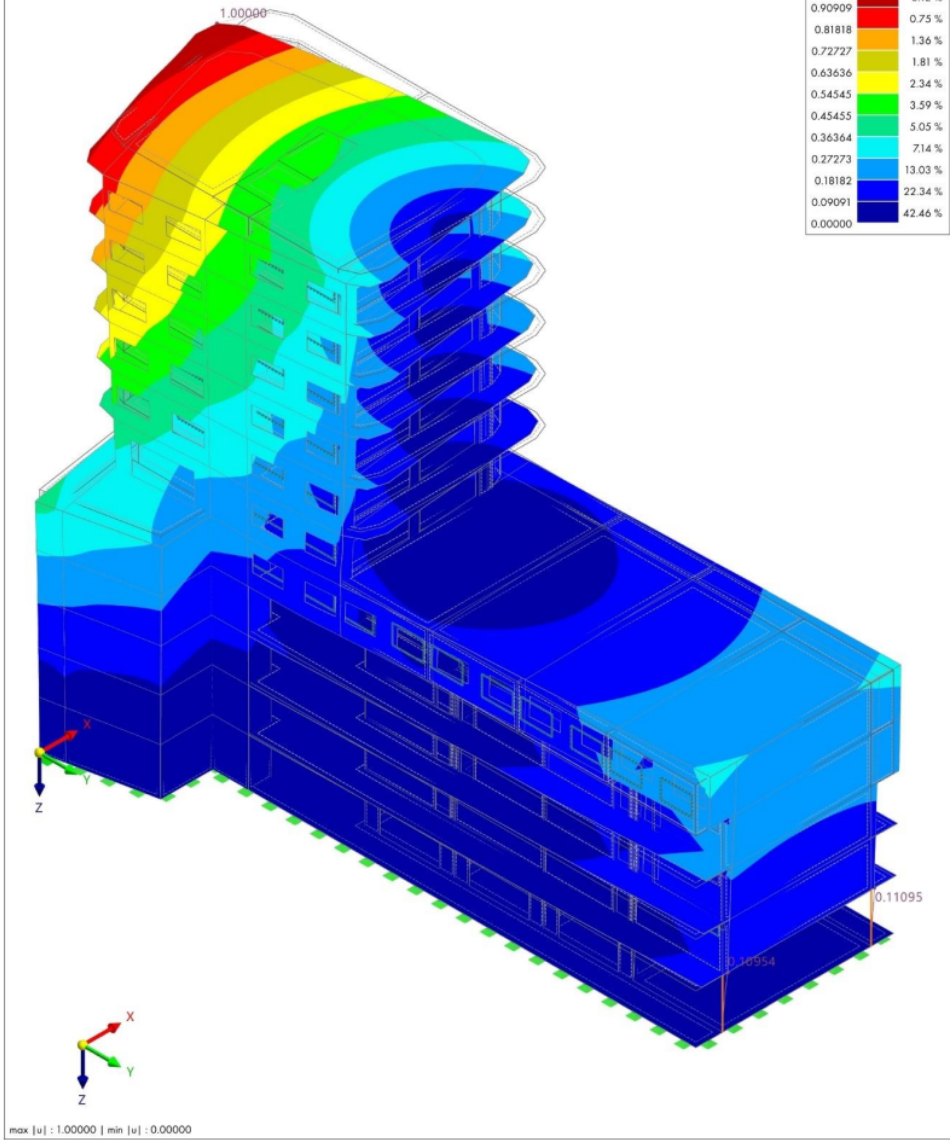

Marija Gulam



Model: diplomski_zgradaA1

Date 21.8.2024 Page 34/38
Sheet 1

MODEL

8.7 LC9: MODE SHAPE |U|, IN AXONOMETRIC DIRECTION

Modal Analysis

LC9 - Potres_modalna
Modal Analysis
Mode No. 4 - 4.298 Hz
Normalized Displacements |u|

In Axonometric Direction

Mode Shape u [-]	
1.00000	0.59 %
0.90909	1.22 %
0.81818	1.84 %
0.72727	2.34 %
0.63636	3.16 %
0.54545	5.01 %
0.45455	6.78 %
0.36364	8.23 %
0.27273	11.63 %
0.18182	21.91 %
0.09091	37.28 %
0.00000	

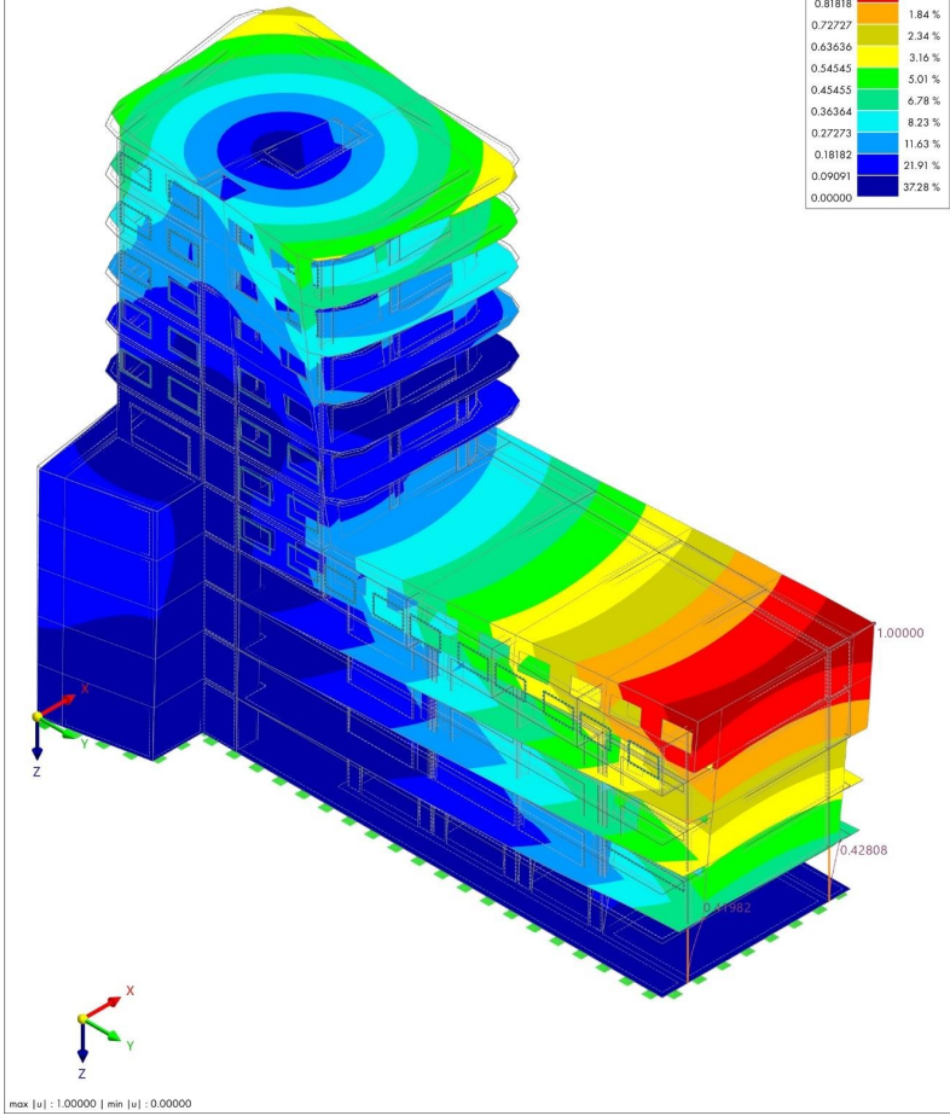

Marija Gulam



Model: diplomski_zgradaA1

Date 21.8.2024 Page 35/38
Sheet 1

MODEL

8.8 LC9: MODE SHAPE |U|, IN AXONOMETRIC DIRECTION

Modal Analysis

LC9 - Potres_modalna
Modal Analysis
Mode No. 5 - 4.913 Hz
Normalized Displacements |u|

In Axonometric Direction

Mode Shape u [-]	
1.00000	0.58 %
0.90909	2.01 %
0.81818	1.78 %
0.72727	10.60 %
0.63636	16.46 %
0.54545	15.80 %
0.45455	6.18 %
0.36364	15.55 %
0.27273	6.34 %
0.18182	13.21 %
0.09091	11.47 %
0.00000	

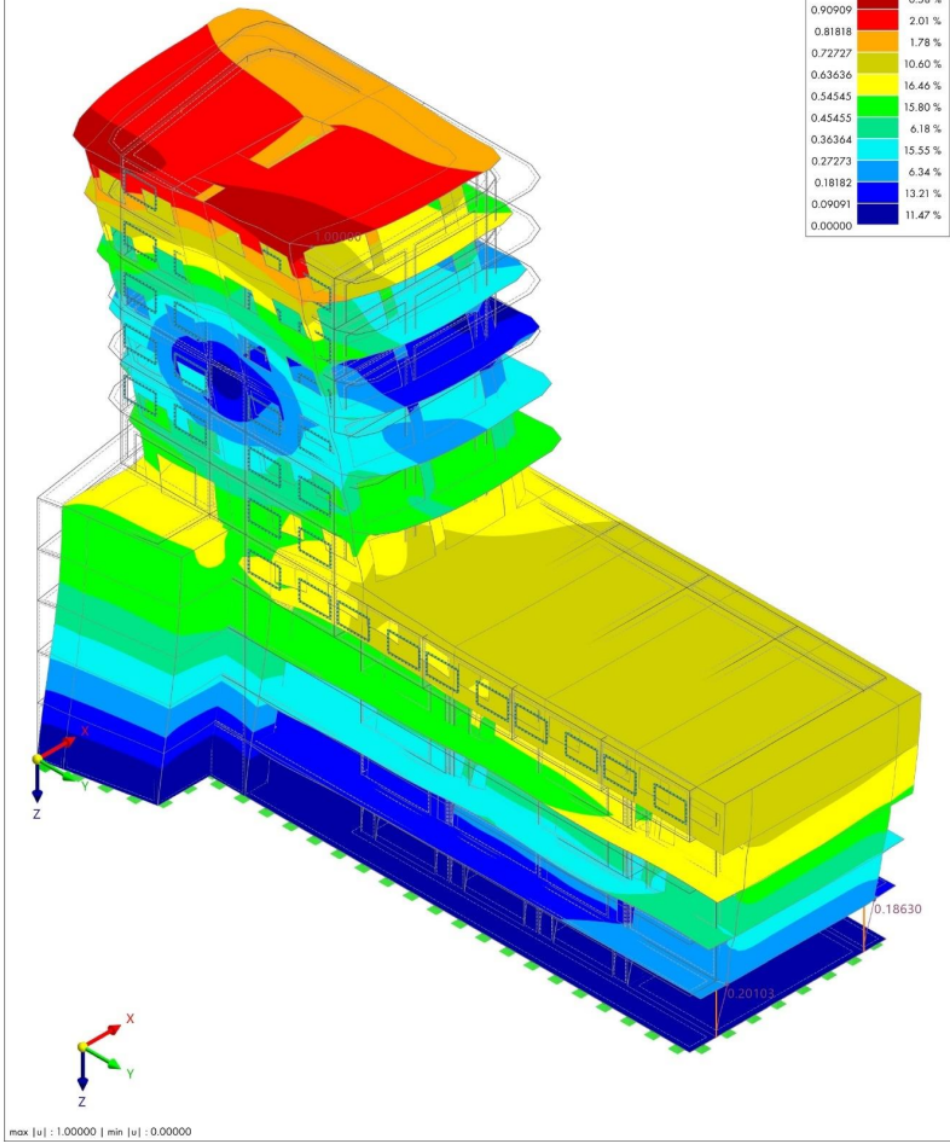

www.dlubal.com

RFEM 6.07.0002 - General 3D structures solved using FEM



Marija Gulam



Model: diplomski_zgradaA1

Date 21.8.2024 Page 36/38
Sheet 1

MODEL

8.9 LC9: MODE SHAPE |U|, IN AXONOMETRIC DIRECTION

Modal Analysis

LC9 - Potres_modalna
Modal Analysis
Mode No. 6 - 9.517 Hz
Normalized Displacements |u|

In Axonometric Direction

Mode Shape u [-]	
1.00000	0.01 %
0.90909	0.05 %
0.81818	0.22 %
0.72727	0.85 %
0.63636	1.70 %
0.54545	3.55 %
0.45455	10.72 %
0.36364	18.43 %
0.27273	26.40 %
0.18182	26.28 %
0.09091	
0.00000	

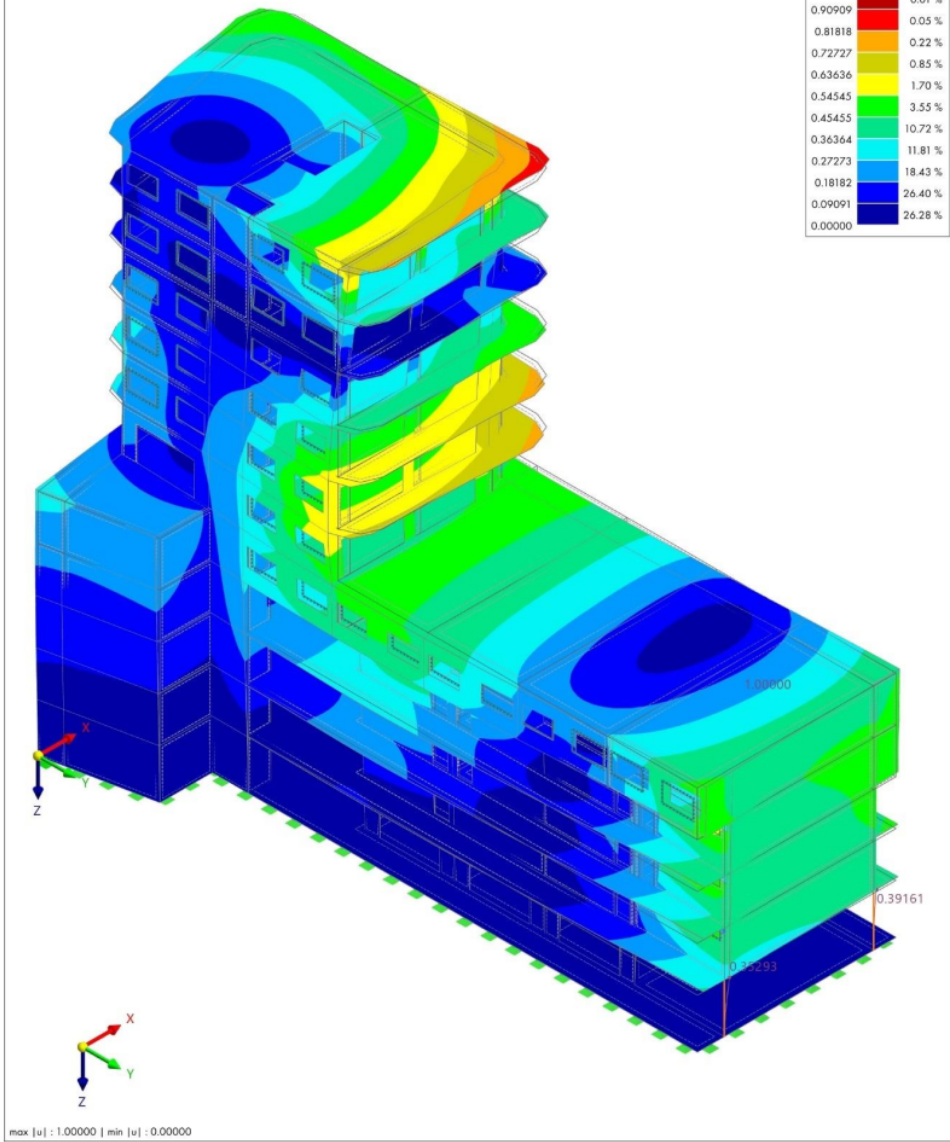

www.dlubal.com

RFEM 6.07.0002 - General 3D structures solved using FEM



Marija Gulam



Model: diplomski_zgradaA1

Date 21.8.2024 Page 37/38
Sheet 1

MODEL

G LC10: ENVELOPE VALUES - MAX AND MIN VALUES, GLOBAL DEFORMATIONS [U], IN AXONOMETRIC DIRECTION

Spectral Analysis

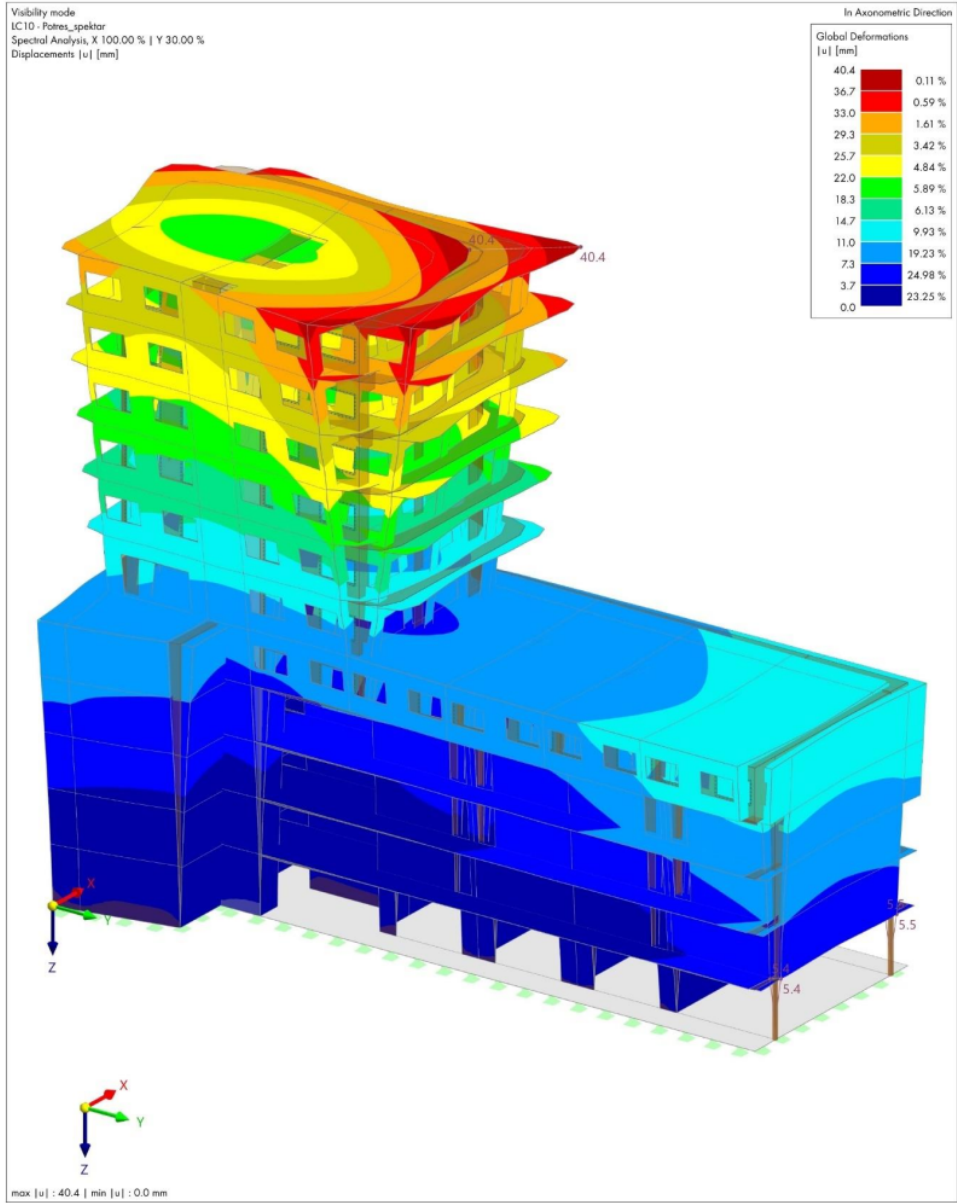

Marija Gulam



Model: diplomski_zgradaA1

Date 21.8.2024 Page 38/38
Sheet 1

MODEL

H LC10: ENVELOPE VALUES - MAX AND MIN VALUES, GLOBAL DEFORMATIONS [U], IN AXONOMETRIC DIRECTION

Spectral Analysis

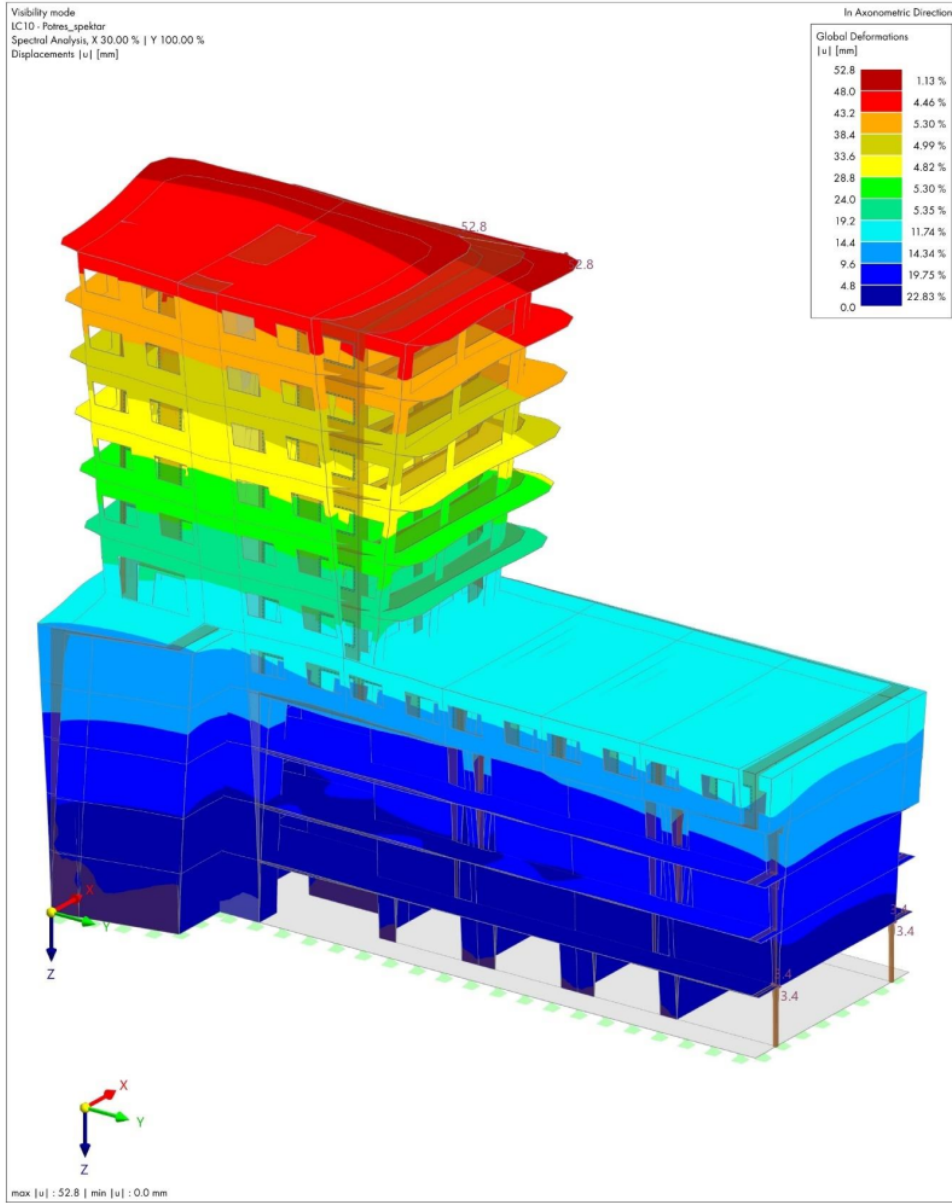

2.4.2 Proračun zgrade B (P+5)

Marija Gulam



Model:
diplomski_zgradaB

Date 21.8.2024 Page 1/33
Sheet 1

MODEL

CONTENTS

1	Basic Objects	2	5.1	Response Spectra	15
1.1	Materials	2	5.1.1	Response Spectra - Parameters	15
1.2	Thicknesses	2	5.1.2	Response Spectra Diagram	15
1.2.1	Thicknesses - Layer Info	2	6	Static Analysis Results	15
1.2.2	Thicknesses - Layers	2	6.1	CO10: Basic Internal Forces m_x , In Axonometric Axonometric Direction	16
1.2.3	Thicknesses - Options for CLT	2	6.2	CO10: Basic Internal Forces m_y , In Axonometric Axonometric Direction	17
1.3	Model, In Axonometric Direction	3	6.3	CO10: Basic Internal Forces n_x , In Axonometric Direction	18
1.4	Model, In Axonometric Direction	4	6.4	CO10: Basic Internal Forces n_y , In Axonometric Direction	19
2	Types for Surfaces	5	6.5	CO57: Global Deformations $ \mu $, In Axonometric Direction	20
2.1	Surface Supports	5	6.6	CO104: Global Deformations $ \mu $, In Axonometric Direction	21
3	Types for Special Objects	5	6.7	CO10: Forces n_x , In Axonometric Direction	22
3.1		5	6.8	CO10: Forces v_x , In Axonometric Direction	23
3.1.1		5	6.9	CO10: Forces v_x , In Axonometric Direction	24
3.1.2	Coupled Diagrams	5	7	Modal Analysis Results	25
4	Load Cases & Combinations	5	7.1	Natural Frequencies	25
4.1	Load Cases	5	7.2	Effective Modal Masses	25
4.2	Static Analysis Settings	6	7.3	Effective Modal Masses - Equivalent Mass per Unit Length	26
4.3	Modal Analysis Settings	7	7.4	LC9: Mode Shape $ \mu $, In Axonometric Direction	27
4.3.1	Modal Analysis Settings - Neglect Masses	7	7.5	LC9: Mode Shape $ \mu $, In Axonometric Direction	28
4.4	Spectral Analysis Settings	8	7.6	LC9: Mode Shape $ \mu $, In Axonometric Direction	29
4.5	Combination Wizards	8	7.7	LC9: Mode Shape $ \mu $, In Axonometric Direction	30
4.5.1	Combination Wizards - Initial State Items	8	7.8	LC9: Mode Shape $ \mu $, In Axonometric Direction	31
A	LC2: Loading, In Axonometric Direction	10	F	LC10: Envelope Values - Max and Min Values, Global Deformations $ \mu $, In Axonometric Direction	32
B	LC3: Loading, In Axonometric Direction	11	G	LC10: Envelope Values - Max and Min Values, Global Deformations $ \mu $, In Axonometric Direction	33
C	LC5: Loading, In Axonometric Direction	12			
D	LC4: Loading, In Axonometric Direction	13			
E	LC6: Loading, In Axonometric Direction	14			
5	Dynamic Loads	15			



Marija Gulam



Model: diplomski_zgradaB

Date: 21.8.2024 Page: 2/33
Sheet: 1

MODEL

1 Basic Objects

1.1 MATERIALS

Legend
 Concrete Settings
 Stiffness modification

Material No.	Material Name	Material Type	Analysis Model	Options
1	C24 BBS XL Orthotropic Linear Elastic (Surfaces)	Timber	Orthotropic Linear Elastic (Surfaces)	
2	C24 BBS XL Orthotropic Linear Elastic (Surfaces)	Timber	Orthotropic Linear Elastic (Surfaces)	
3	GL32h Isotropic Linear Elastic	Timber	Isotropic Linear Elastic	
4	C35/45 Isotropic Linear Elastic	Concrete	Isotropic Linear Elastic	

1.2 THICKNESSES

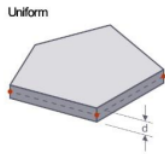

Thick. No.	Type	Assigned to Surface No.	Material	Symbol	Thickness		
					Value	Unit	Nodes
1	Layers d : 220.0 mm Layers: 7 Layers	54,79-81,88-91,93,95,237-239,24 6-249,251,255,261,344-346,428-4 32,437-439,446-449,451,453,483- 487,489-494					
2	Layers d : 140.0 mm Layers: 5 Layers	1-6,8,11-19,55-58,62-86,96,130-1 38,240-244,252,253,256,259,260, 306-314,433-436,440-444,454,45 6-463,470-476,502-506,513-518					
3	Uniform d : 200.0 mm 4 - C35/45 Uniform	92,250,347,450,455,464-469,477- 482,495-501,507-512,519-524	4	d	200.0	mm	

1.2.1 THICKNESSES - LAYER INFO

Thick. No.	Total Thickness d [mm]	Total Weight g [N/m²]	Direction of Main Thickness	Comment
1	220.0	990.0	0.00	
2	140.0	630.0	0.00	

1.2.2 THICKNESSES - LAYERS

Thick. No.	Layer No.	Object	Material	Thickness t [mm]	Rotation β [deg]	Number of Int. Points	Spec. W _g [N/m²]	Weight g [N/m²]
1	1	Directly	1	40.0	0.00	9	4500.0	180.0
	2	Directly	2	40.0	90.00	9	4500.0	180.0
	3	Directly	1	20.0	0.00	9	4500.0	90.0
	4	Directly	2	20.0	90.00	9	4500.0	90.0
	5	Directly	1	20.0	0.00	9	4500.0	90.0
	6	Directly	2	40.0	90.00	9	4500.0	180.0
	7	Directly	1	40.0	0.00	9	4500.0	180.0
2	1	Directly	1	40.0	0.00	9	4500.0	180.0
	2	Directly	2	20.0	90.00	9	4500.0	90.0
	3	Directly	1	20.0	0.00	9	4500.0	90.0
	4	Directly	2	20.0	90.00	9	4500.0	90.0
	5	Directly	1	40.0	0.00	9	4500.0	180.0

1.2.3 THICKNESSES - OPTIONS FOR CLT

Thick. No.	Name	Options for CLT	Symbol	Value	Unit
1	Design for failure of net section and failure in glued contact surface is enabled.			<input type="checkbox"/>	
2	Design for failure of net section and failure in glued contact surface is enabled.			<input type="checkbox"/>	



Marija Gulam



Model:
diplomski_zgradaB

Date: 21.8.2024 Page: 3/33
Sheet: 1

MODEL

1.3 MODEL, IN AXONOMETRIC DIRECTION

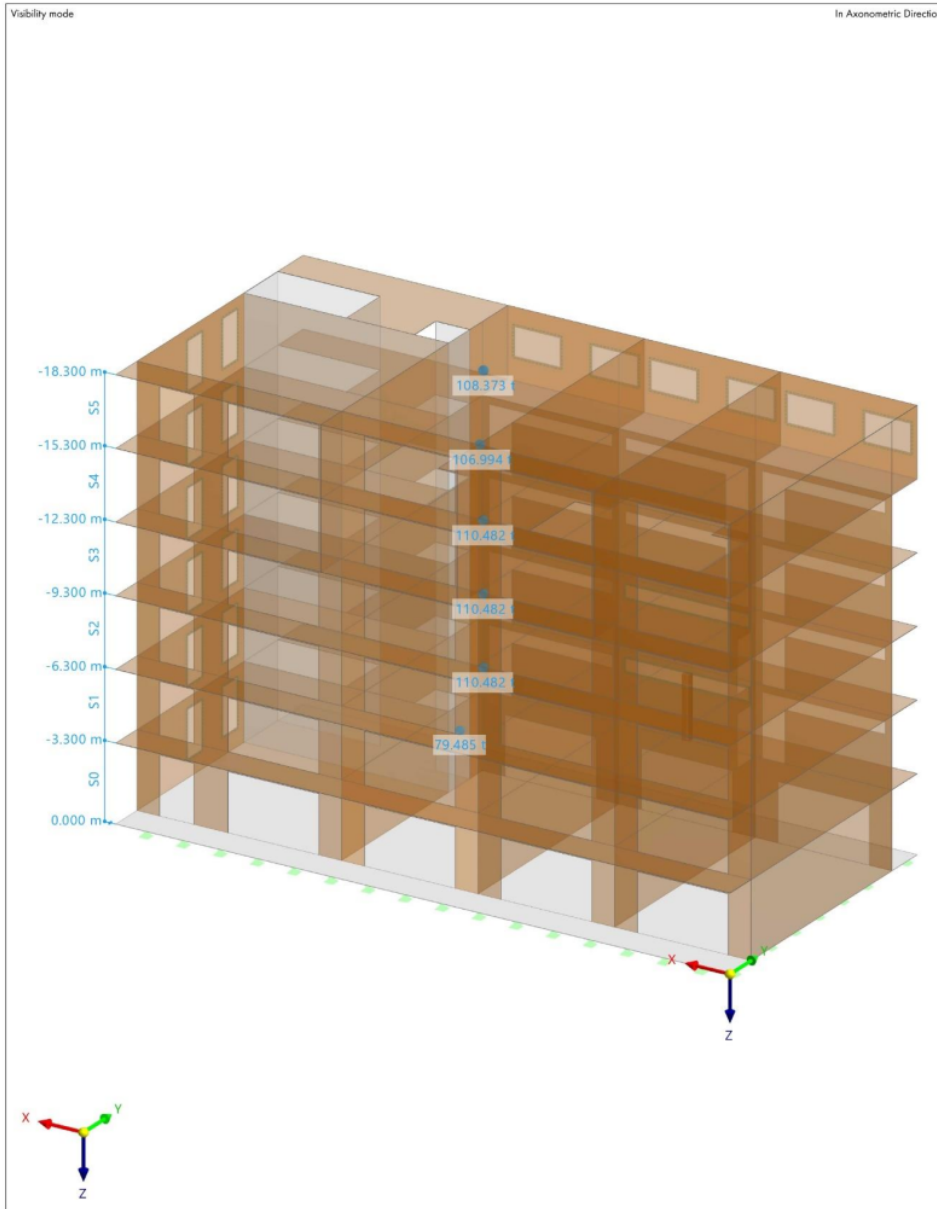

Marija Gulam



Model:
diplomski_zgradaB

Date: 21.8.2024 Page: 4/33
Sheet: 1

MODEL

1.4 MODEL, IN AXONOMETRIC DIRECTION

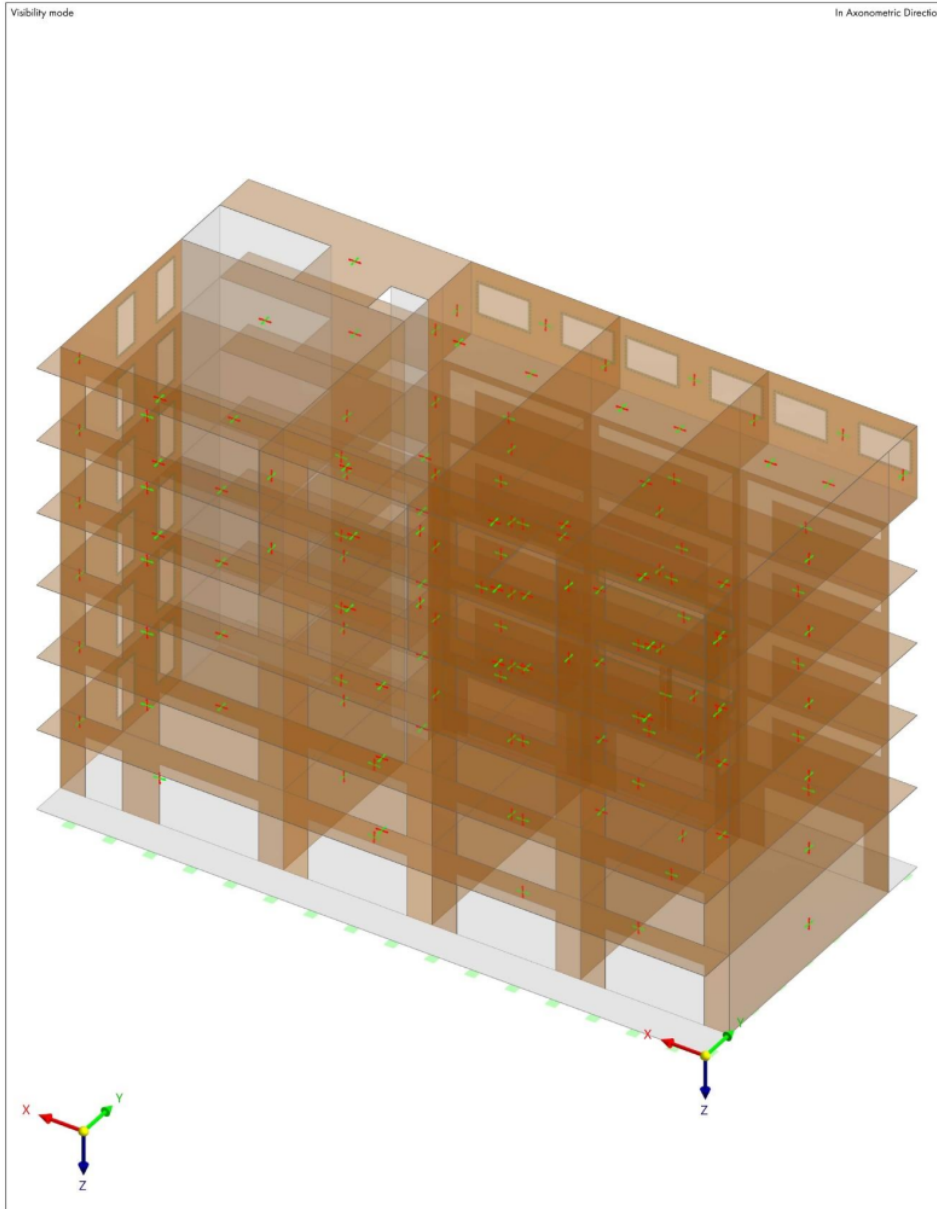

Marija Gulam



Model: diplomski_zgradaB

Date: 21.8.2024 Page: 5/33
Sheet: 1

MODEL

2 Types for Surfaces

2.1 SURFACE SUPPORTS

Support No.	Surfaces No.	Translational Spring			Shear Spring	
		C_{ux} [kN/m ²]	C_{uy} [kN/m ²]	C_{uz} [kN/m ²]	$C_{v,xz}$ [kN/m]	$C_{v,yz}$ [kN/m]
1	<input checked="" type="checkbox"/> <input checked="" type="checkbox"/> <input checked="" type="checkbox"/> Rigid 92,250,347,450,455,495	<input checked="" type="checkbox"/>	<input checked="" type="checkbox"/>	<input checked="" type="checkbox"/>	<input checked="" type="checkbox"/>	<input checked="" type="checkbox"/>

3 Types for Special Objects

3.1 LINE RELEASE TYPES

Release No.	Local Axis System		Translational Spring [kN/m ²]			Spring Constant $C_{p,x}$ [kNm rad ⁻¹ m ³]	Rot. Angle β [deg]
	Type	No. In Plane	C_{ux}	C_{uy}	C_{uz}		
1	<input type="checkbox"/> <input type="checkbox"/> <input checked="" type="checkbox"/> Line Releases: 50-63 Original line		<input type="checkbox"/>	<input type="checkbox"/>	<input type="checkbox"/>	<input checked="" type="checkbox"/>	0.00

3.1.1 LINE RELEASE TYPES - ACCEPTANCE CRITERIA FOR DIAGRAMMS

Release No.	Description	Acceptance Criteria for Diagramms		
		Symbol	Value	Unit
1	<input type="checkbox"/> <input type="checkbox"/> <input checked="" type="checkbox"/> Line Releases: 50-63			

3.1.2 LINE RELEASE TYPES - ACCEPTANCE CRITERIA FOR COUPLED DIAGRAMMS

Release No.	Description	Acceptance Criteria for Coupled Diagramms		
		Symbol	Value	Unit
1	<input type="checkbox"/> <input type="checkbox"/> <input checked="" type="checkbox"/> Line Releases: 50-63			

4 Load Cases & Combinations

4.1 LOAD CASES

Legend
⚡ Accidental torsion

LC No.	Settings	Value	Unit	To Solve	Options
1	1.1.1 Self-weight			<input checked="" type="checkbox"/>	
	Analysis type	Static Analysis			
	Associated standard	EN 1990 Base + Timber CEN 2010-04			
	Static analysis settings	SA1 - Geometrically linear Newton-Raphson			
	Action category	1.1.1 Permanent			
	Self-weight - Factor in direction X	0.000	--		
	Self-weight - Factor in direction Y	0.000	--		
	Self-weight - Factor in direction Z	1.000	--		
	Load duration	Permanent			
	Self-weight mode for geotechnical analysis	Normal			
2	1.1.2 Dodatno stalno			<input checked="" type="checkbox"/>	
	Analysis type	Static Analysis			
	Associated standard	EN 1990 Base + Timber CEN 2010-04			
	Static analysis settings	SA1 - Geometrically linear Newton-Raphson			
	Action category	1.1.2 Permanent			
	Load duration	Permanent			
	Self-weight mode for geotechnical analysis	Normal			
3	1.1.3 Uporabno			<input checked="" type="checkbox"/>	
	Analysis type	Static Analysis			
	Associated standard	EN 1990 Base + Timber CEN 2010-04			
	Static analysis settings	SA1 - Geometrically linear Newton-Raphson			
	Action category	1.1.3 Imposed loads - category A: domestic, residential areas			
	Load duration	Medium-term			
	Factor Phi	Independently occupied floors			
	Self-weight mode for geotechnical analysis	Normal			
	Imposed load is considered as fatigue	<input type="checkbox"/>			
4	1.1.4 Srijeg			<input checked="" type="checkbox"/>	
	Analysis type	Static Analysis			
	Associated standard	EN 1990 Base + Timber CEN 2010-04			
	Static analysis settings	SA1 - Geometrically linear Newton-Raphson			



Marija Gulam



Model: diplomski_zgradaB

Date: 21.8.2024 Page: 6/33
Sheet: 1

LOADS

4.1 **LOAD CASES**

LC No.	Settings	Value	Unit	To Solve	Options
	Action category	CS Snow/ice loads - H <= 1000 m			
	Load duration	Short-term			
	Self-weight mode for geotechnical analysis	Normal			
5	Uporabno krov				
	Analysis type	Static Analysis		<input checked="" type="checkbox"/>	
	Associated standard	EN 1990 Base + Timber CEN 2010-04			
	Static analysis settings	SA1 - Geometrically linear Newton-Raphson			
	Action category	Imposed loads - category A: domestic, residential areas			
	Load duration	Medium-term			
	Factor Phi	Roofs			
	Self-weight mode for geotechnical analysis	Normal			
	Imposed load is considered as fatigue	<input type="checkbox"/>			
6	Vjetar pritiskajuci				
	Analysis type	Static Analysis		<input checked="" type="checkbox"/>	
	Associated standard	EN 1990 Base + Timber CEN 2010-04			
	Static analysis settings	SA1 - Geometrically linear Newton-Raphson			
	Action category	Wind			
	Load duration	Short-term			
	Self-weight mode for geotechnical analysis	Normal			
7	Vjetar odizuci				
	Analysis type	Static Analysis		<input checked="" type="checkbox"/>	
	Associated standard	EN 1990 Base + Timber CEN 2010-04			
	Static analysis settings	SA1 - Geometrically linear Newton-Raphson			
	Action category	Wind			
	Load duration	Short-term			
	Self-weight mode for geotechnical analysis	Normal			
9	Potres				
	Analysis type	Modal Analysis		<input checked="" type="checkbox"/>	
	Associated standard	EN 1990 Base + Timber CEN 2010-04			
	Modal analysis settings	MOS1 - #30 Lanczos			
	Import masses from	CO168			
	Action category	Seismic actions			
	Self-weight mode for geotechnical analysis	Normal			
10					
	Analysis type	Response Spectrum Analysis		<input checked="" type="checkbox"/>	<input checked="" type="checkbox"/>
	Associated standard	EN 1990 Base + Timber CEN 2010-04			
	Spectral analysis settings	SPS1 - SRSS Scaled Sum 30.00 %			
	Import modal analysis from	LC9			
	Action category	Seismic actions			
	Load duration	Instantaneous			
	Self-weight mode for geotechnical analysis	Normal			

4.2 **STATIC ANALYSIS SETTINGS**

Settings No.	Description	Symbol	Value	Unit
1	Geometrically linear Newton-Raphson			
	Analysis type		Geometrically linear	
	Iterative method for nonlinear analysis		Newton-Raphson	
	Maximum number of iterations		100	
	Number of load increments		1	
	Modify standard precision and tolerance settings	<input type="checkbox"/>		
	Ignore all nonlinearities	<input type="checkbox"/>		
	Modify loading by multiplier factor	<input type="checkbox"/>		
	Displacements due to member load of type 'Pipe internal pressure' (Bourdon effect)	<input type="checkbox"/>		
	Method for equation system		Direct	
	Plate bending theory		Mindlin	
	Activate mass conversion to load	<input type="checkbox"/>		
	Asymmetric direct solver	<input checked="" type="checkbox"/>		
	Equilibrium for undeformed structure	<input type="checkbox"/>		
	Stability check based on deformation rate	<input type="checkbox"/>		
2	Second-order (P-Δ) Picard 100 1			
	Analysis type		Second-order (P-Δ)	
	Iterative method for nonlinear analysis		Picard	
	Maximum number of iterations		100	
	Number of load increments		1	
	Modify standard precision and tolerance settings	<input type="checkbox"/>		
	Ignore all nonlinearities	<input type="checkbox"/>		



Marija Gulam



Model: diplomski_zgradaB

Date: 21.8.2024 Page: 7/33
Sheet: 1

MODEL

4.2 **STATIC ANALYSIS SETTINGS**

Settings No.	Description	Symbol	Value	Unit
	Modify loading by multiplier factor		<input type="checkbox"/>	
	Consider favorable effect due to tension in members		<input checked="" type="checkbox"/>	
	Displacements due to member load of type 'Pipe internal pressure' (Bourdon effect)		<input type="checkbox"/>	
	Refer internal forces to deformed structure		<input checked="" type="checkbox"/>	
	Refer internal forces to deformed structure for axial forces		<input checked="" type="checkbox"/>	
	Refer internal forces to deformed structure for shear forces		<input checked="" type="checkbox"/>	
	Refer internal forces to deformed structure for moments		<input checked="" type="checkbox"/>	
	Method for equation system		Direct	
	Plate bending theory		Mindlin	
	Activate mass conversion to load		<input type="checkbox"/>	
	Asymmetric direct solver		<input checked="" type="checkbox"/>	
	Equilibrium for undeformed structure		<input type="checkbox"/>	
	Stability check based on deformation rate		<input type="checkbox"/>	
3	<input checked="" type="checkbox"/> Large deformations Newton-Raphson 100 1			
	Analysis type		<input checked="" type="checkbox"/> Large deformations	
	Iterative method for nonlinear analysis		<input checked="" type="checkbox"/> Newton-Raphson	
	Maximum number of iterations		100	
	Number of load increments		1	
	Modify standard precision and tolerance settings		<input type="checkbox"/>	
	Ignore all nonlinearities		<input type="checkbox"/>	
	Modify loading by multiplier factor		<input type="checkbox"/>	
	Consider favorable effect due to tension in members		<input checked="" type="checkbox"/>	
	Try to calculate unstable structure		<input type="checkbox"/>	
	Displacements due to member load of type 'Pipe internal pressure' (Bourdon effect)		<input type="checkbox"/>	
	Method for equation system		Direct	
	Plate bending theory		Mindlin	
	Activate mass conversion to load		<input type="checkbox"/>	
	Asymmetric direct solver		<input checked="" type="checkbox"/>	
	Equilibrium for undeformed structure		<input type="checkbox"/>	
	Stability check based on deformation rate		<input type="checkbox"/>	

4.3 **MODAL ANALYSIS SETTINGS**

Settings No.	Description	Symbol	Value	Unit
1	<input checked="" type="checkbox"/> #30 Lanczos			
	Number of modes method		User-Defined	
	Number of modes		30	
	Solution method		Lanczos	
	Mass matrix type		<input checked="" type="checkbox"/> Consistent	
	Acting masses in X-direction enabled	u _x	<input checked="" type="checkbox"/>	
	Acting masses in Y-direction enabled	u _y	<input checked="" type="checkbox"/>	
	Acting masses in Z-direction enabled	u _z	<input type="checkbox"/>	
	Acting masses about X-axis enabled	φ _x	<input type="checkbox"/>	
	Acting masses about Y-axis enabled	φ _y	<input type="checkbox"/>	
	Acting masses about Z-axis enabled	φ _z	<input type="checkbox"/>	
	Mass conversion type		Z-components of loads	
	Neglect masses		User-Defined	
2	<input checked="" type="checkbox"/> #10 Lanczos			
	Number of modes method		User-Defined	
	Number of modes		10	
	Solution method		Lanczos	
	Mass matrix type		<input checked="" type="checkbox"/> Consistent	
	Acting masses in X-direction enabled	u _x	<input checked="" type="checkbox"/>	
	Acting masses in Y-direction enabled	u _y	<input checked="" type="checkbox"/>	
	Acting masses in Z-direction enabled	u _z	<input type="checkbox"/>	
	Acting masses about X-axis enabled	φ _x	<input type="checkbox"/>	
	Acting masses about Y-axis enabled	φ _y	<input type="checkbox"/>	
	Acting masses about Z-axis enabled	φ _z	<input type="checkbox"/>	
	Mass conversion type		Z-components of loads	
	Neglect masses		In all fixed nodal and line supports	

4.3.1 **MODAL ANALYSIS SETTINGS - NEGLECT MASSES**

MA No.	Object Type	Object List	Components in Direction			Components About Axis			Comment
			u _x	u _y	u _z	φ _x	φ _y	φ _z	
1	Surface	92,250,347,450,45,5,485	<input checked="" type="checkbox"/>	<input checked="" type="checkbox"/>	<input checked="" type="checkbox"/>	<input checked="" type="checkbox"/>	<input checked="" type="checkbox"/>	<input checked="" type="checkbox"/>	



Marija Gulam



Model: diplomski_zgradaB

Date: 21.8.2024 Page: 8/33
Sheet: 1

MODEL

4.4 SPECTRAL ANALYSIS SETTINGS

Settings No.	Description	Symbol	Value	Unit
1	SRSS Scaled Sum 30.00 %			
	Combination rule for periodic responses	SRSS		
	Use equivalent linear combination	<input type="checkbox"/>		
	Signed results using dominant mode	<input type="checkbox"/>		
	Save results of all selected modes	<input checked="" type="checkbox"/>		
	Combination rule for directional components	Scaled Sum		
	Combination rule for directional components		30.00 %	
	Consider independent directions in envelope results	<input type="checkbox"/>		

4.5 COMBINATION WIZARDS

Wizard No.	Settings	Value
1	Load combinations SA2 - Second-order (P-Δ) Picard 100 1	
	Assigned to	DS 1-6
	Generate combinations	Load combinations (non-linear analysis)
	Static analysis settings	SA2 - Second-order (P-Δ) Picard 100 1
	Consider imperfection case	<input checked="" type="checkbox"/>
	Consider initial state	<input type="checkbox"/>
	Structure modification enabled	<input type="checkbox"/>
	Generate same combinations without imperfection case	<input type="checkbox"/>
	User-defined action combinations	<input type="checkbox"/>
	Favorable permanent actions	<input type="checkbox"/>
	Reduce number of generated combinations	<input type="checkbox"/>
	Assigned to	DS 1-6
	Generate combinations	Load combinations (non-linear analysis)
	Static analysis settings	SA2 - Second-order (P-Δ) Picard 100 1
	Consider imperfection case	<input checked="" type="checkbox"/>
	Consider initial state	<input type="checkbox"/>
	Structure modification enabled	<input type="checkbox"/>
	Generate same combinations without imperfection case	<input type="checkbox"/>
	User-defined action combinations	<input type="checkbox"/>
	Favorable permanent actions	<input type="checkbox"/>
	Reduce number of generated combinations	<input type="checkbox"/>
2	Load combinations SA1 - Geometrically linear Newton-Raphson	
	Assigned to	Load combinations (non-linear analysis)
	Generate combinations	SA1 - Geometrically linear Newton-Raphson
	Static analysis settings	
	Consider imperfection case	<input type="checkbox"/>
	Consider initial state	<input type="checkbox"/>
	Structure modification enabled	<input type="checkbox"/>
	User-defined action combinations	<input type="checkbox"/>
	Favorable permanent actions	<input type="checkbox"/>
	Reduce number of generated combinations	<input type="checkbox"/>
	Assigned to	Load combinations (non-linear analysis)
	Generate combinations	SA1 - Geometrically linear Newton-Raphson
	Static analysis settings	
	Consider imperfection case	<input type="checkbox"/>
	Consider initial state	<input type="checkbox"/>
	Structure modification enabled	<input type="checkbox"/>
	User-defined action combinations	<input type="checkbox"/>
	Favorable permanent actions	<input type="checkbox"/>
	Reduce number of generated combinations	<input type="checkbox"/>
3	Result combinations	
	Assigned to	DS 7
	Generate combinations	Result combinations (linear analysis)
	Consider imperfection case	<input type="checkbox"/>
	Generate as permanent superposition	<input checked="" type="checkbox"/>
	User-defined action combinations	<input type="checkbox"/>
	Favorable permanent actions	<input type="checkbox"/>
	Assigned to	DS 7
	Generate combinations	Result combinations (linear analysis)
	Consider imperfection case	<input type="checkbox"/>
	User-defined action combinations	<input type="checkbox"/>
	Favorable permanent actions	<input type="checkbox"/>

4.5.1 COMBINATION WIZARDS - INITIAL STATE ITEMS

Wizard No.	Definition Type	Case Object
1	Load combinations SA2 - Second-order (P-Δ) Picard 100 1	
2	Load combinations SA1 - Geometrically linear Newton-Raphson	

Marija Gulam



Model:

diplomski_zgradaB

Date: 21.8.2024

Page: 9/33

Sheet: 1

MODEL

4.5.1 COMBINATION WIZARDS - INITIAL STATE ITEMS

Wizard No.	Definition Type	Case Object
3	Result combinations	



Marija Gulam



Model:
diplomski_zgradaB

Date 21.8.2024 Page 10/33
Sheet 1

MODEL

A LC2: LOADING, IN AXONOMETRIC DIRECTION

LC2 - Dodatno stalno
Loads [kN/m²]

In Axonometric Direction

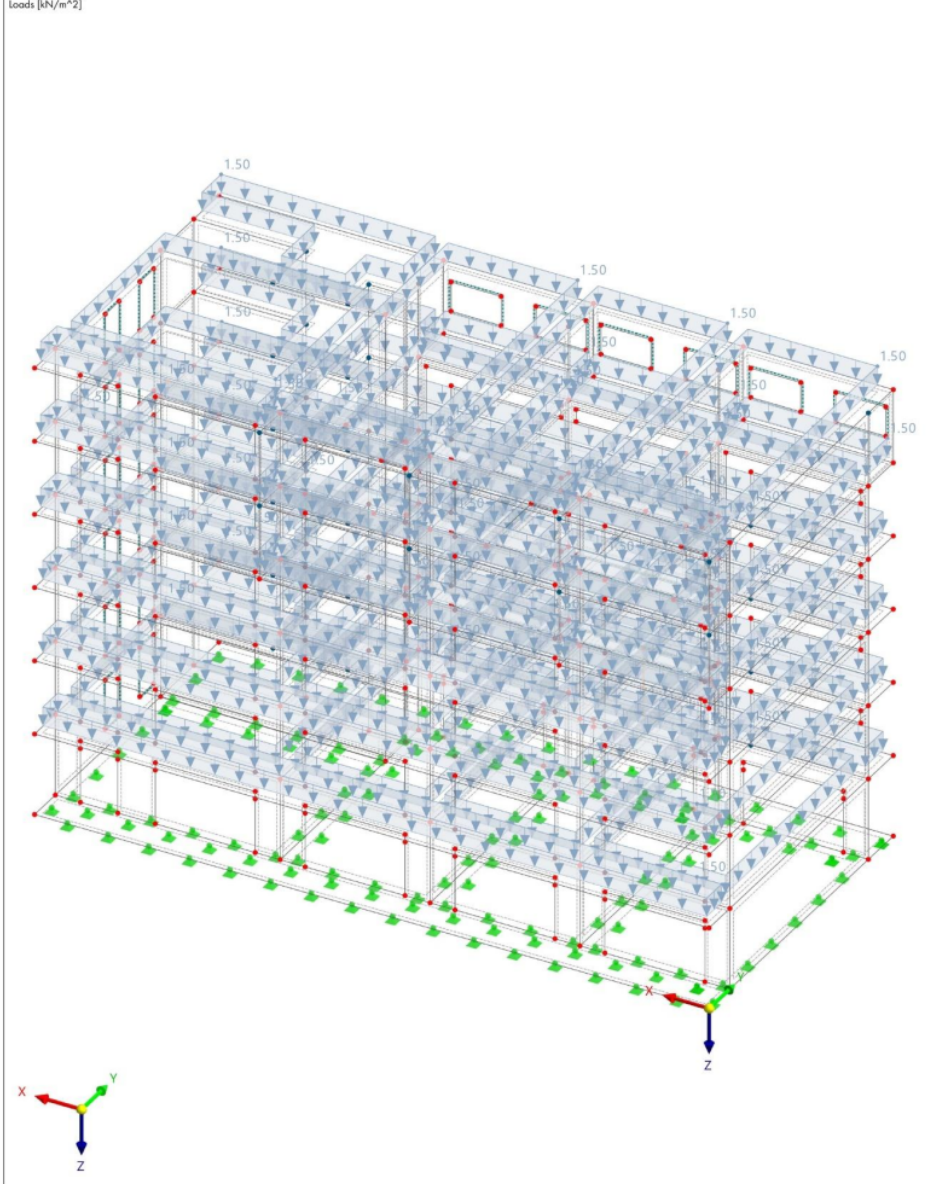

Marija Gulam



Model:
diplomski_zgradaB

Date 21.8.2024 Page 11/33
Sheet 1

MODEL

LC3: LOADING, IN AXONOMETRIC DIRECTION

[LC3 - Uporabno
Loads [kN/m²]

In Axonometric Direction

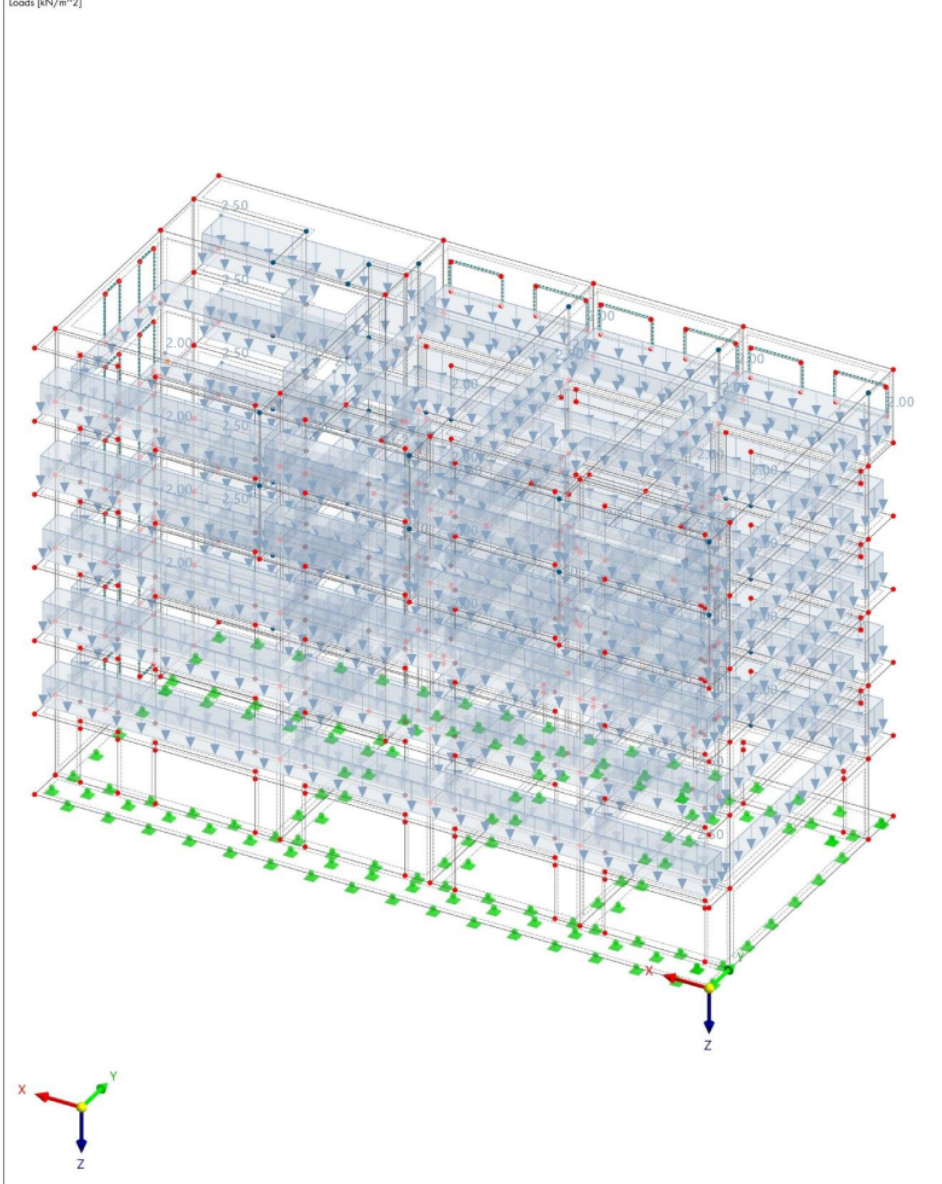

Marija Gulam



Model:
diplomski_zgradaB

Date 21.8.2024 Page 12/33
Sheet 1

MODEL

c LC5: LOADING, IN AXONOMETRIC DIRECTION

LC5 - Uporabno krov
Loads [kN/m²]

In Axonometric Direction

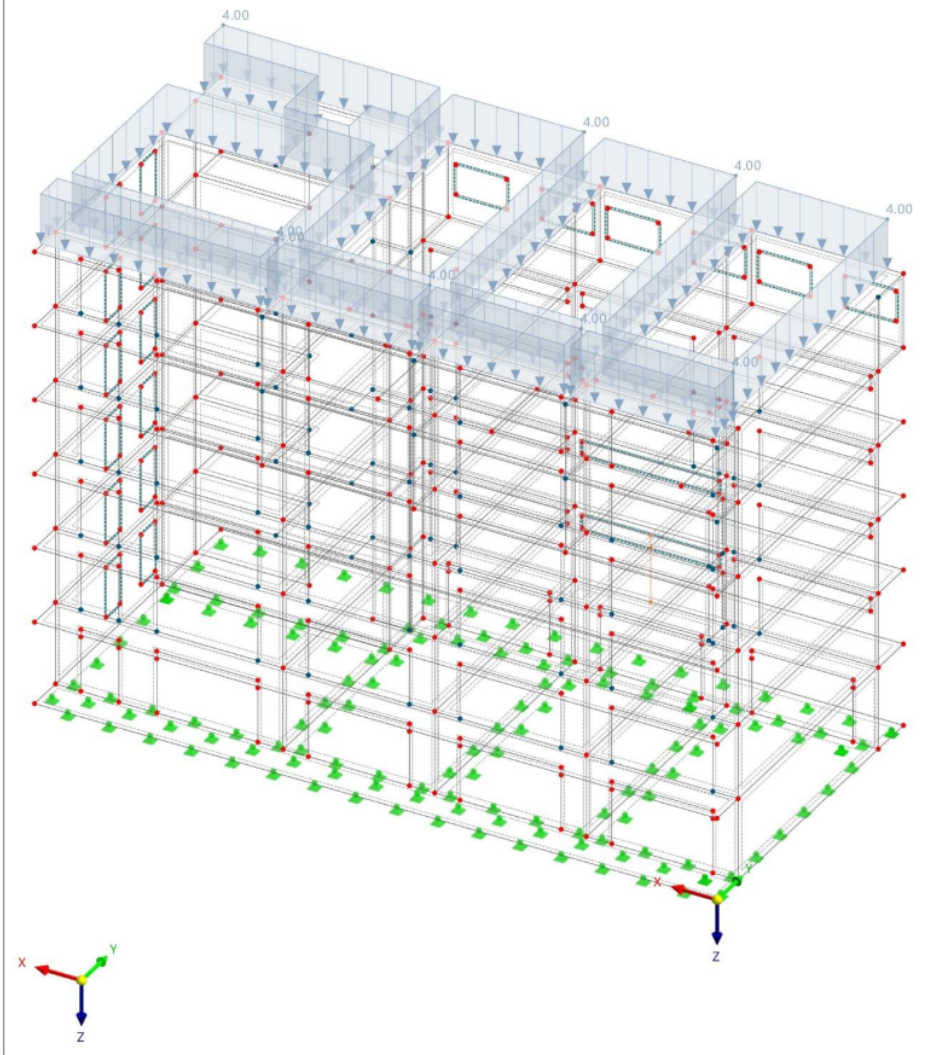

Marija Gulam



Model:
diplomski_zgradaB

Date 21.8.2024 Page 13/33
Sheet 1

MODEL

D LC4: LOADING, IN AXONOMETRIC DIRECTION

[LC4 - Snijeg
Loads [kN/m²]

In Axonometric Direction

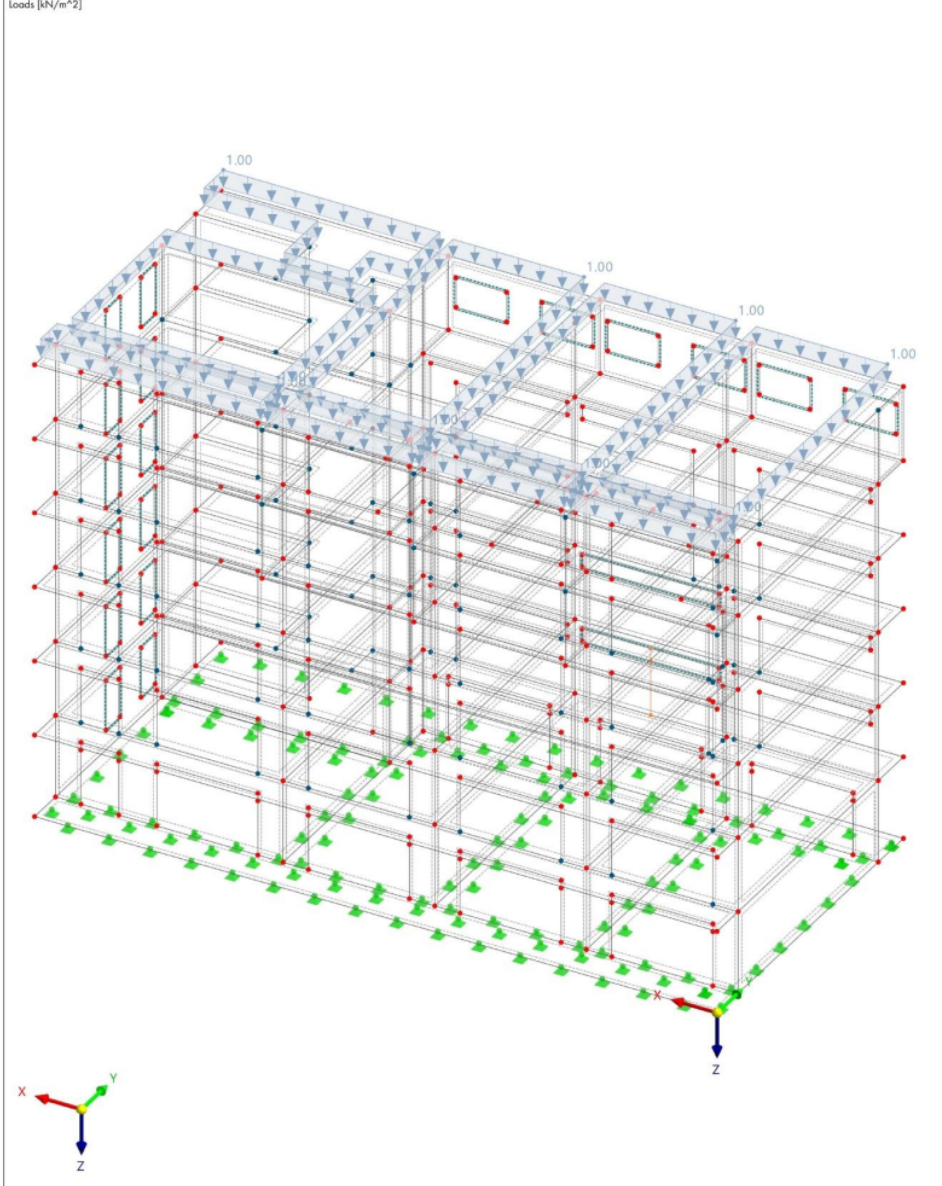

Marija Gulam



Model:
diplomski_zgradaB

Date 21.8.2024 Page 14/33
Sheet 1

MODEL

E LC6: LOADING, IN AXONOMETRIC DIRECTION

[LC6 - Vjetar pritisak]
Loads [kN/m²]

In Axonometric Direction

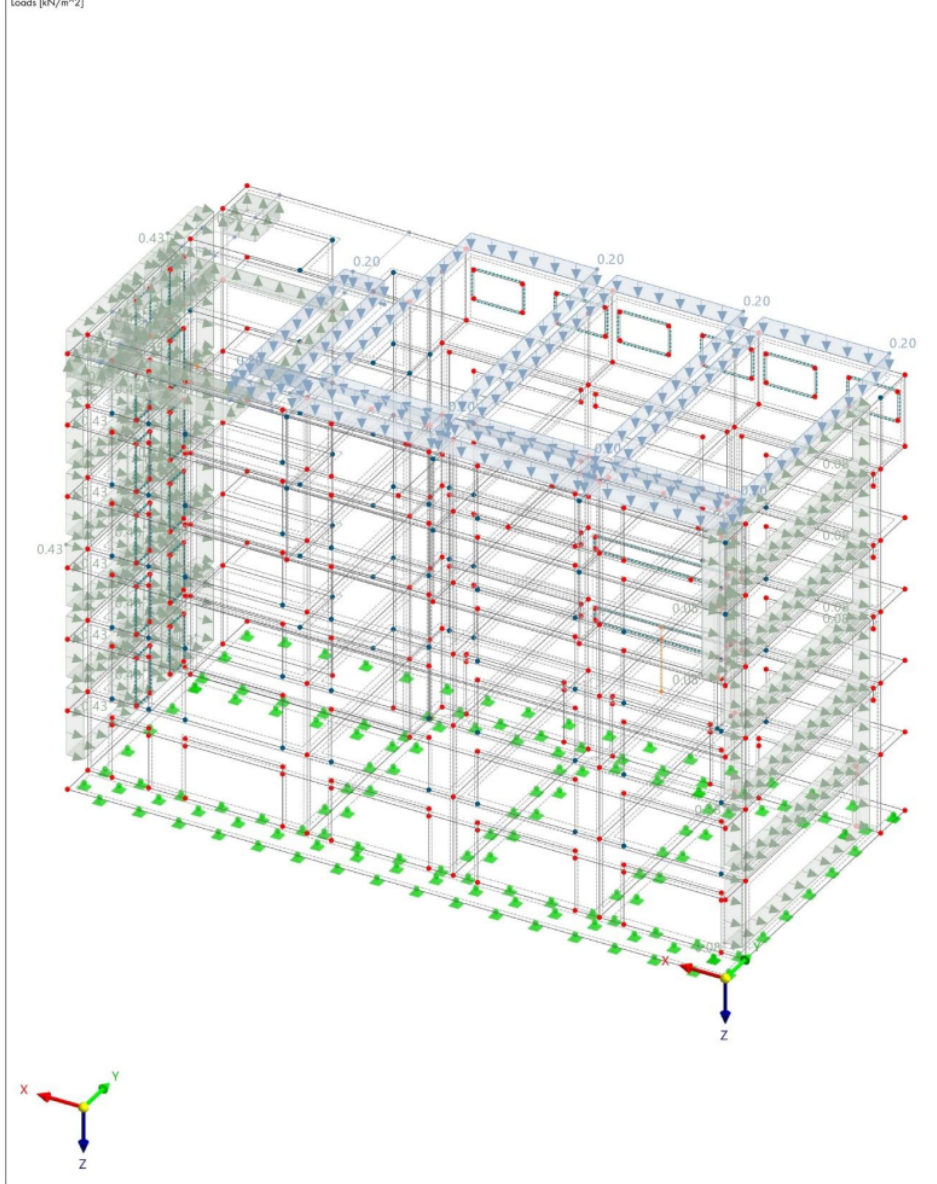

Marija Gulam



Model: diplomski_zgradaB

Date: 21.8.2024 Page: 15/33
Sheet: 1

MODEL

5 Dynamic Loads

5.1 RESPONSE SPECTRA

RS No.	Definition Type	Comment
1	According to Standard - EN 1998-1 HRN 2011-06	

5.1.1 RESPONSE SPECTRA - PARAMETERS

RS No.	Parameter	Symbol	Value	Unit	Reference
1	According to Standard - EN 1998-1 HRN 2011-06				
	Type of spectrum		Design Spectrum		
	Spectrum shape		Horizontal		
	Spectrum direction		A		
	Ground type				
	Earthquake action				
	Reference peak ground acceleration	a_{gR}	25.00	%	
	Importance class		II		
	Design ground acceleration Horizontal	γ_I	1.000	-	4.2.5(5)P
		a_g	0.250	-	
	Factors				
	Behavior factor	q	1.500	-	
	Limit value	β	0.200	-	3.2.2.2(4)P, NA 2.11
	Ground type parameters				
	Soil factor Ground type A	S	1.000	-	3.2.2.2(2)P, Tab. 3.2
	Control period Ground type A	T_B	0.150	s	3.2.2.2(2)P, Tab. 3.2
	Control period Ground type A	T_C	0.400	s	3.2.2.2(2)P, Tab. 3.2
	Control period Ground type A	T_D	2.000	s	3.2.2.2(2)P, Tab. 3.2
	Maximum period	T_{max}	4.000	s	

5.1.2 RESPONSE SPECTRA | DIAGRAM

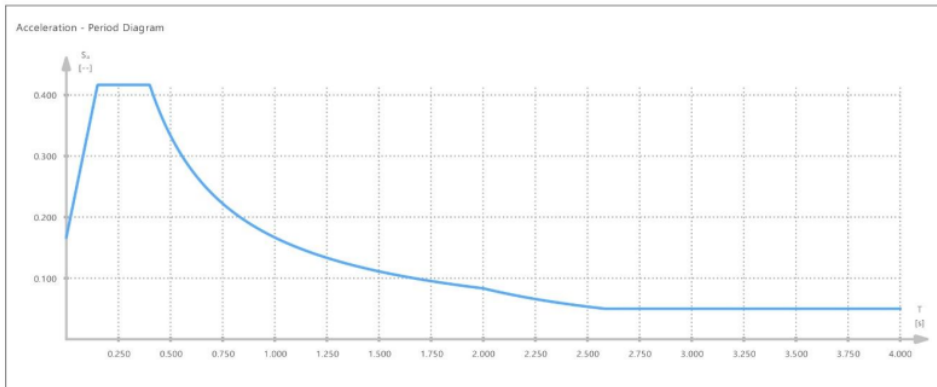

6 Static Analysis Results



Marija Gulam



Model:
diplomski_zgradaB

Date 21.8.2024 Page 16/33
Sheet 1

MODEL

6.1 CO10: BASIC INTERNAL FORCES M_x IN AXONOMETRIC DIRECTION

Static Analysis

CO10 - 1.35 * IC1 + 1.35 * IC2 + 1.50 * IC3 + 1.50 * IC5 + 0.75 * IC4 + 0.90 * IC6
Static Analysis
Moments m_x [kNm/m]

In Axonometric Direction

Surfaces Internal Forces Basic Internal Forces m_x [kNm/m]	
85.270	0.00 %
72.548	0.00 %
59.826	0.00 %
47.104	0.16 %
34.382	0.76 %
21.660	6.69 %
8.939	80.54 %
-3.783	10.10 %
-16.505	1.49 %
-29.227	0.22 %
-41.949	0.04 %
-54.671	

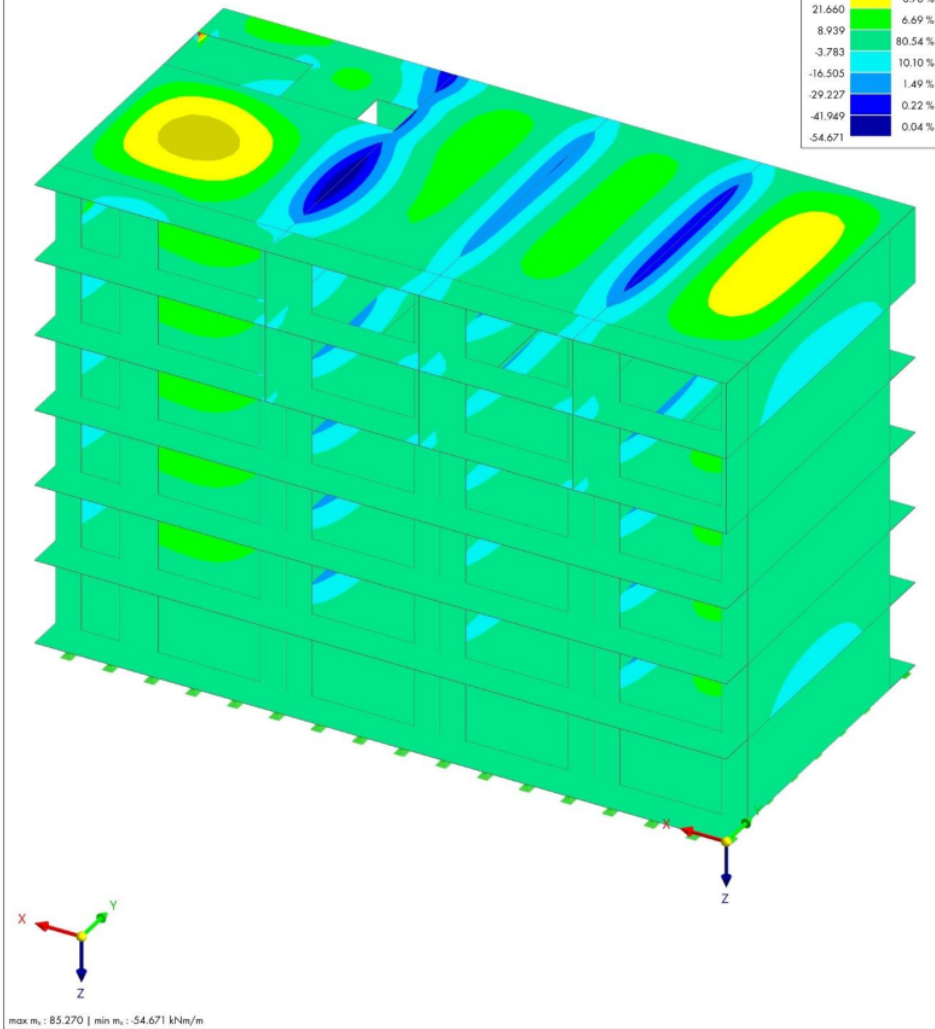

Marija Gulam



Model:
diplomski_zgradaB

Date: 21.8.2024 Page: 17/33
Sheet: 1

MODEL

6.2 CO10: BASIC INTERNAL FORCES M_y , IN AXONOMETRIC DIRECTION

Static Analysis

CO10 - 1.35 * IC1 + 1.35 * IC2 + 1.50 * IC3 + 1.50 * IC5 + 0.75 * IC4 + 0.90 * IC6
Static Analysis
Moments m_y [kNm/m]

In Axonometric Direction

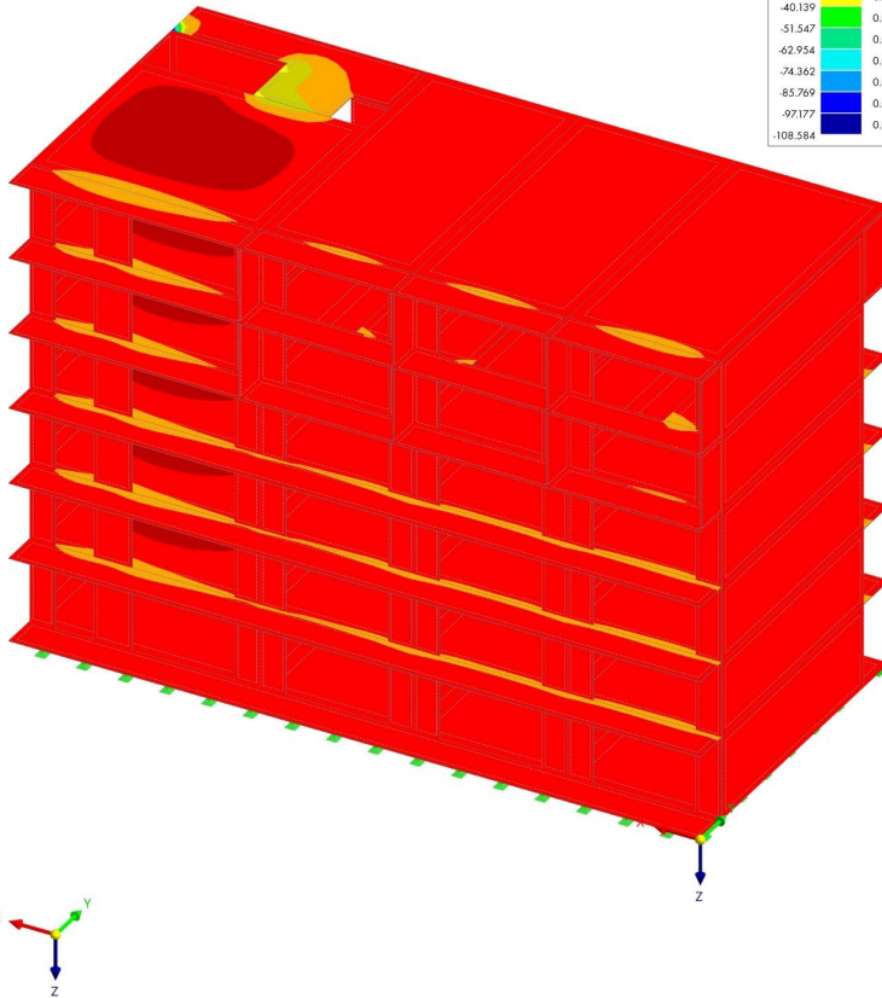

max m_y : 16.898 | min m_y : -108.584 kNm/m

Marija Gulam



Model:
diplomski_zgradaB

Date: 21.8.2024 Page: 18/33
Sheet: 1

MODEL

6.3 CO10: BASIC INTERNAL FORCES N_x IN AXONOMETRIC DIRECTION

Static Analysis

CO10 - 1.35 * IC1 + 1.35 * IC2 + 1.50 * IC3 + 1.50 * IC5 + 0.75 * IC4 + 0.90 * IC6
Static Analysis
Axial Forces n_x [kN/m]

In Axonometric Direction

Surfaces Internal Forces Basic Internal Forces n_x [kN/m]	
284.462	0.00 %
204.035	0.01 %
123.609	0.16 %
43.182	6.784 %
-37.245	13.66 %
-117.672	10.00 %
-198.098	5.81 %
-278.525	1.84 %
-358.952	0.62 %
-439.378	0.07 %
-519.805	0.00 %
-600.232	

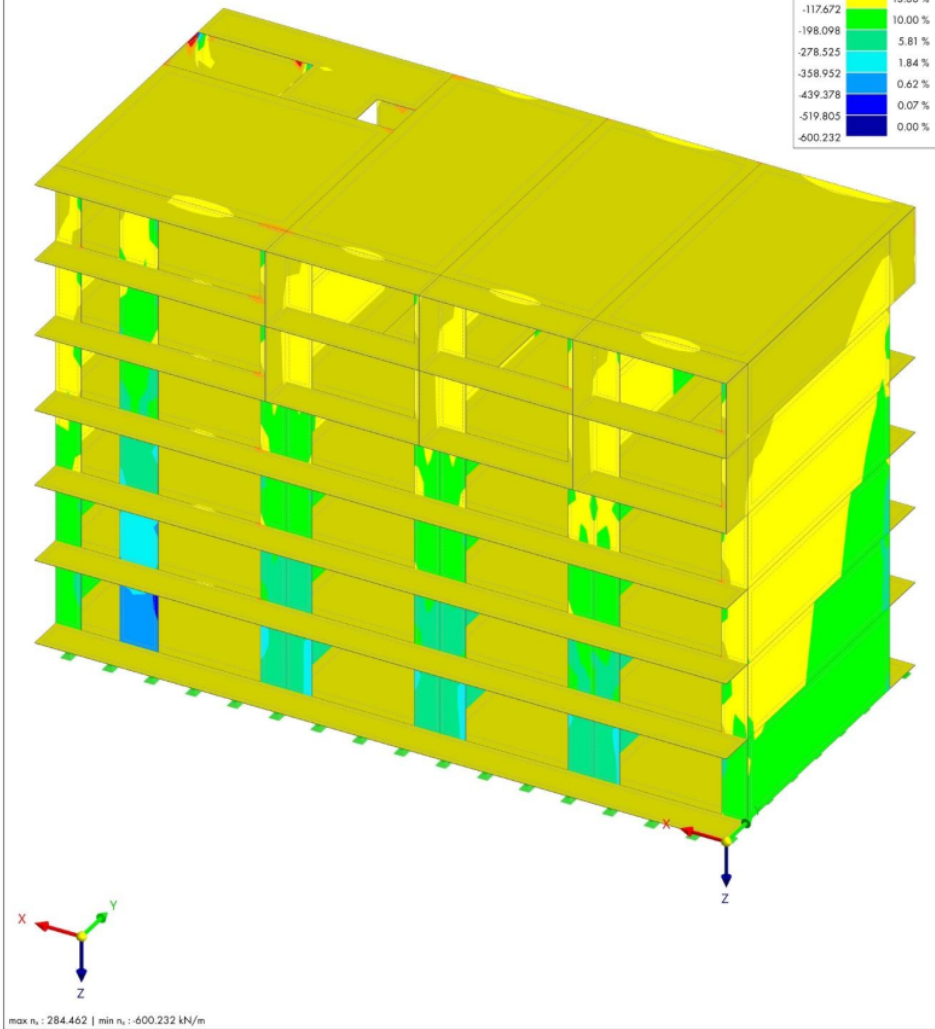

Marija Gulam



Model:
diplomski_zgradaB

Date: 21.8.2024 Page: 19/33
Sheet: 1

MODEL

6.4 CO10: BASIC INTERNAL FORCES N_y , IN AXONOMETRIC DIRECTION

Static Analysis

CO10 - 1.35 * IC1 + 1.35 * IC2 + 1.50 * IC3 + 1.50 * IC5 + 0.75 * IC4 + 0.90 * IC6
Static Analysis
Axial Forces n_y , [kN/m]

In Axonometric Direction

Surfaces Internal Forces Basic Internal Forces n_y [kN/m]	
350.564	0.00 %
282.389	0.00 %
214.214	0.02 %
146.039	0.15 %
77.864	4.68 %
9.689	94.84 %
-58.486	0.29 %
-126.661	0.02 %
-194.836	0.00 %
-263.011	0.00 %
-331.186	0.00 %
-399.361	0.00 %

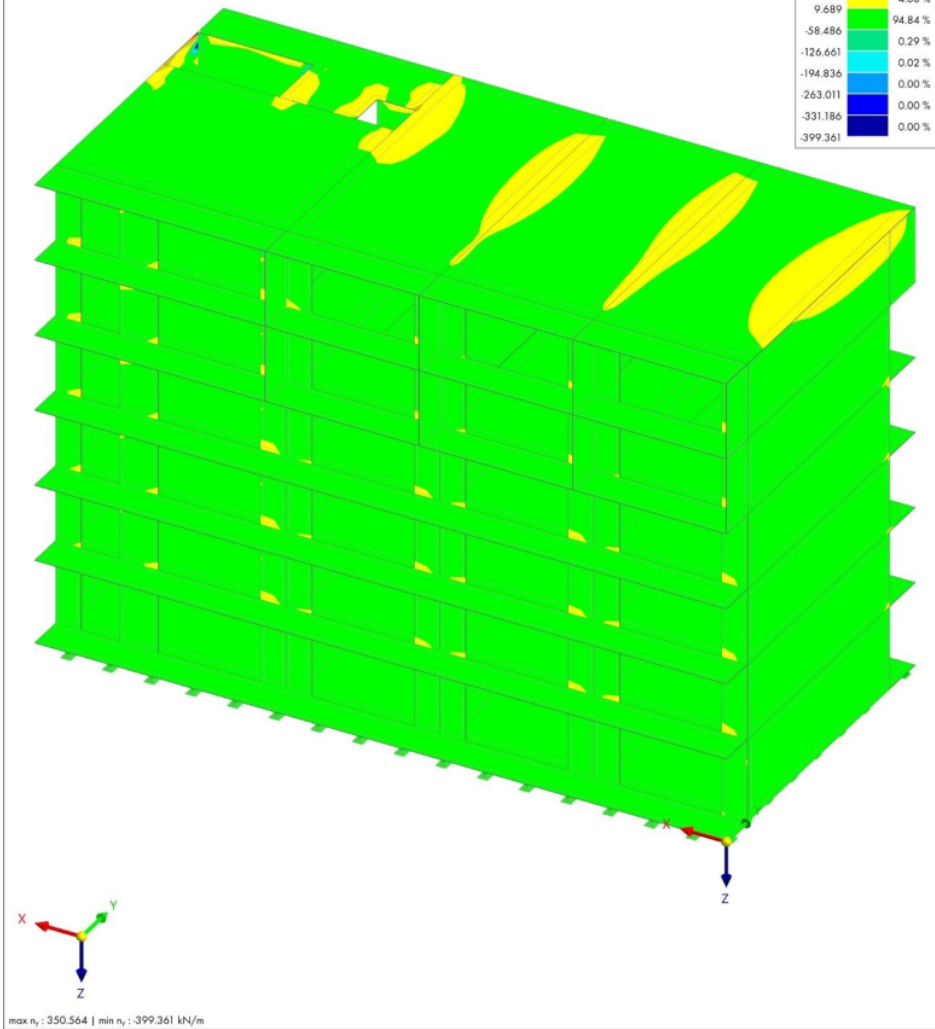

max n_y : 350.564 | min n_y : -399.361 kN/m



Marija Gulam



Model:
diplomski_zgradaB

Date 21.8.2024 Page 20/33
Sheet 1

MODEL

6.5 COS7: GLOBAL DEFORMATIONS [U], IN AXONOMETRIC DIRECTION

Static Analysis

COS7 - IC1 + IC2 + IC3 + IC5 + 0.50 * IC4 + 0.60 * IC6
Static Analysis
Displacements [u] [mm]

In Axonometric Direction

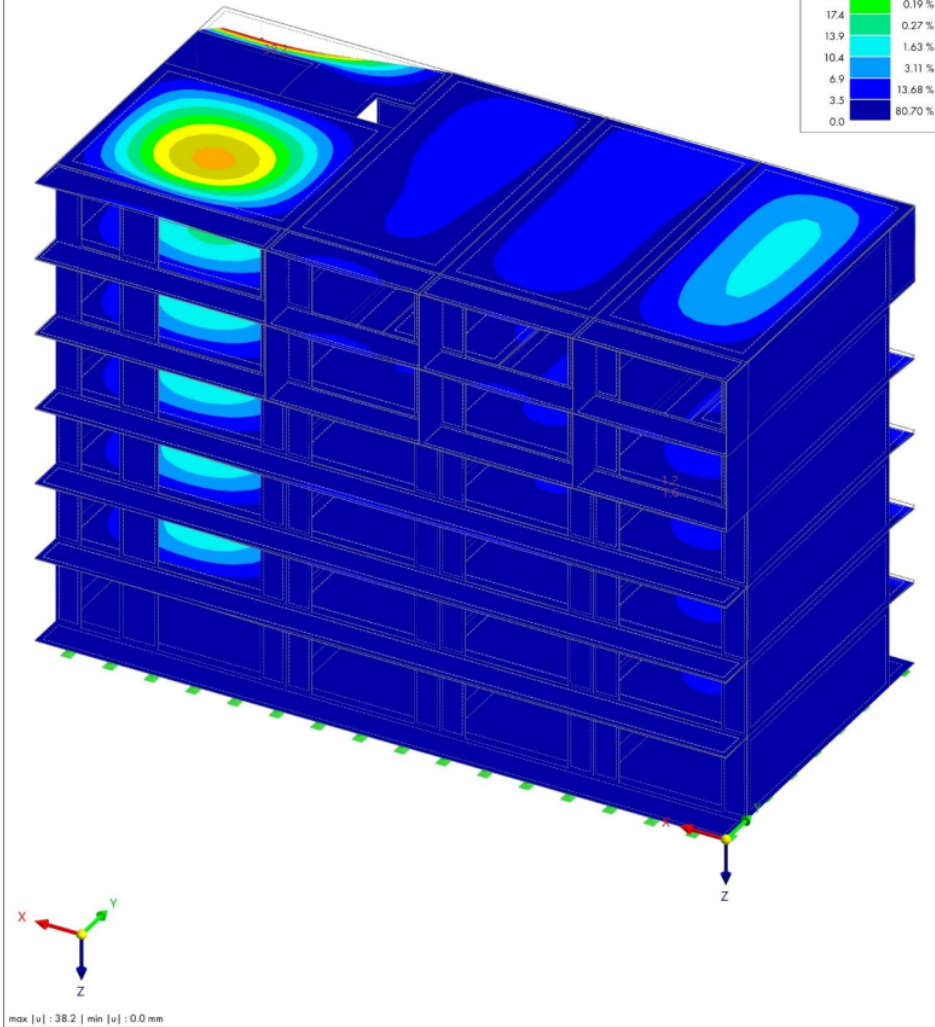
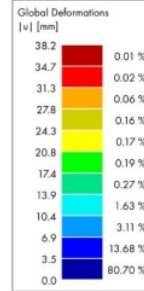

Marija Gulam



Model:
diplomski_zgradaB

Date 21.8.2024 Page 21/33
Sheet 1

MODEL

6.6 CO104: GLOBAL DEFORMATIONS |U|, IN AXONOMETRIC DIRECTION

Static Analysis

CO104 - 1.60 * IC1 + 1.60 * IC2 + 1.18 * IC3 + 1.18 * IC5 + 0.50 * IC4 + 0.60 * IC6
Static Analysis
Displacements |u| [mm]

In Axonometric Direction

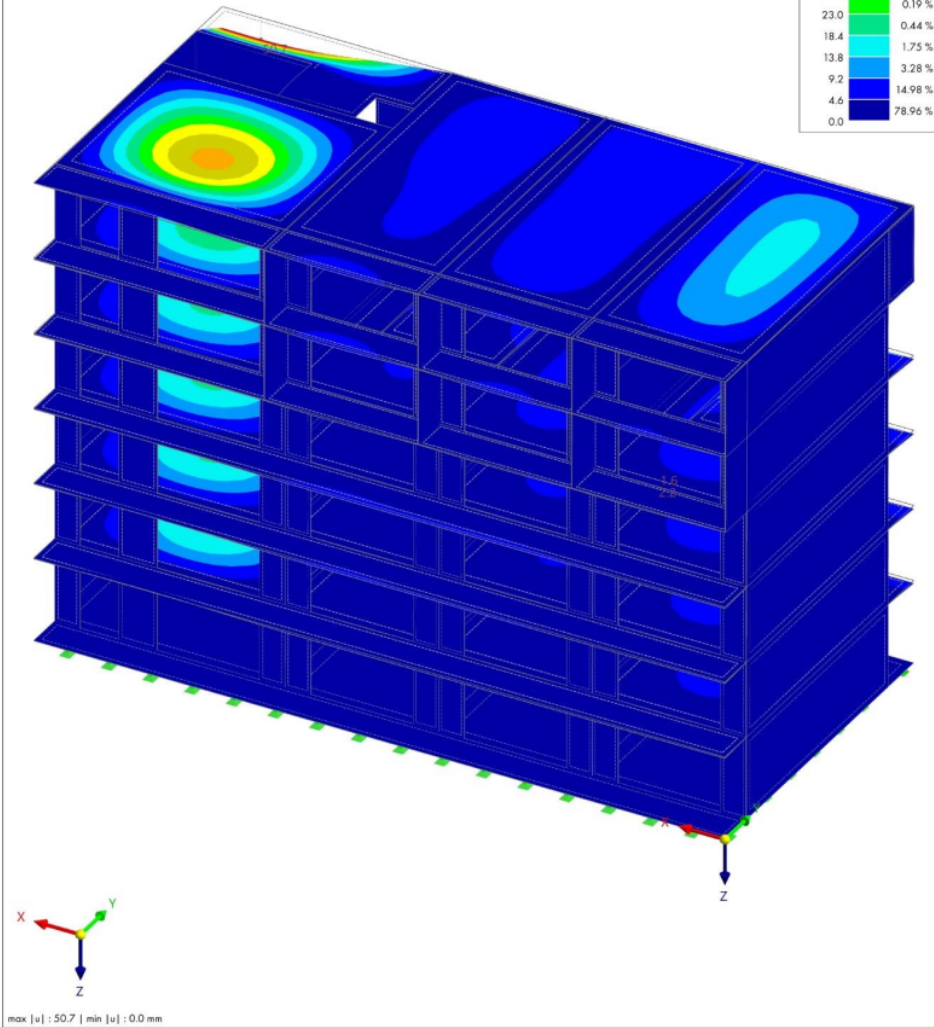

Marija Gulam



Model: diplomski_zgradaB

Date: 21.8.2024 Page: 22/33
Sheet: 1

MODEL

6.7 CO10: FORCES N, IN AXONOMETRIC DIRECTION

Static Analysis

Visibility mode
CO10 - 1.35 * IC1 + 1.35 * IC2 + 1.50 * IC3 + 1.50 * IC5 + 0.75 * IC4 + 0.90 * IC6
Static Analysis
Forces n [kN/m]

In Axonometric Direction

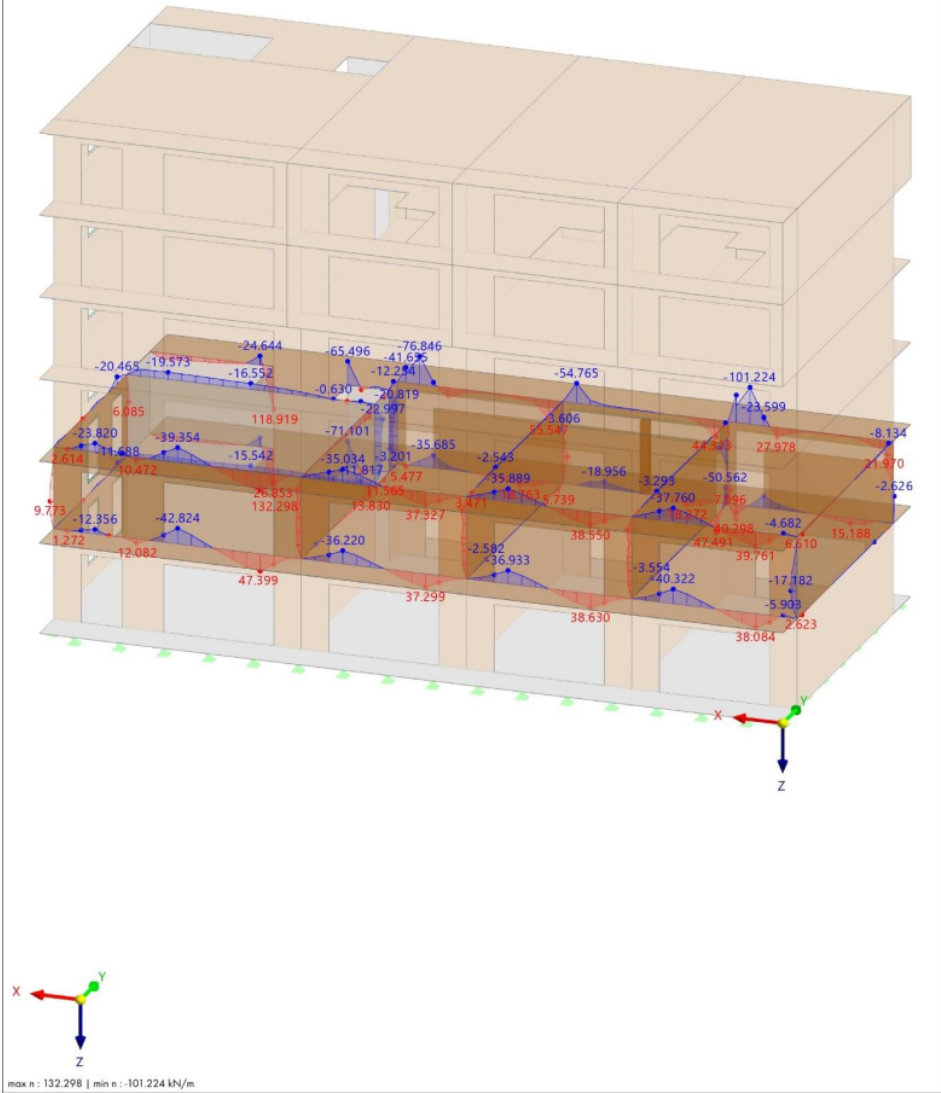

max n : 132.298 | min n : -101.224 kN/m

www.dlubal.com

RFEM 6.07.0002 - General 3D structures solved using FEM



Marija Gulam



Model:
diplomski_zgradaB

Date: 21.8.2024 Page: 23/33
Sheet: 1

MODEL

6.8 CO10: FORCES V_y , IN AXONOMETRIC DIRECTION

Static Analysis

Visibility mode
CO10 - 1.35 * IC1 + 1.35 * IC2 + 1.50 * IC3 + 1.50 * IC5 + 0.75 * IC4 + 0.90 * IC6
Static Analysis
Forces v_y [kN/m]

In Axonometric Direction

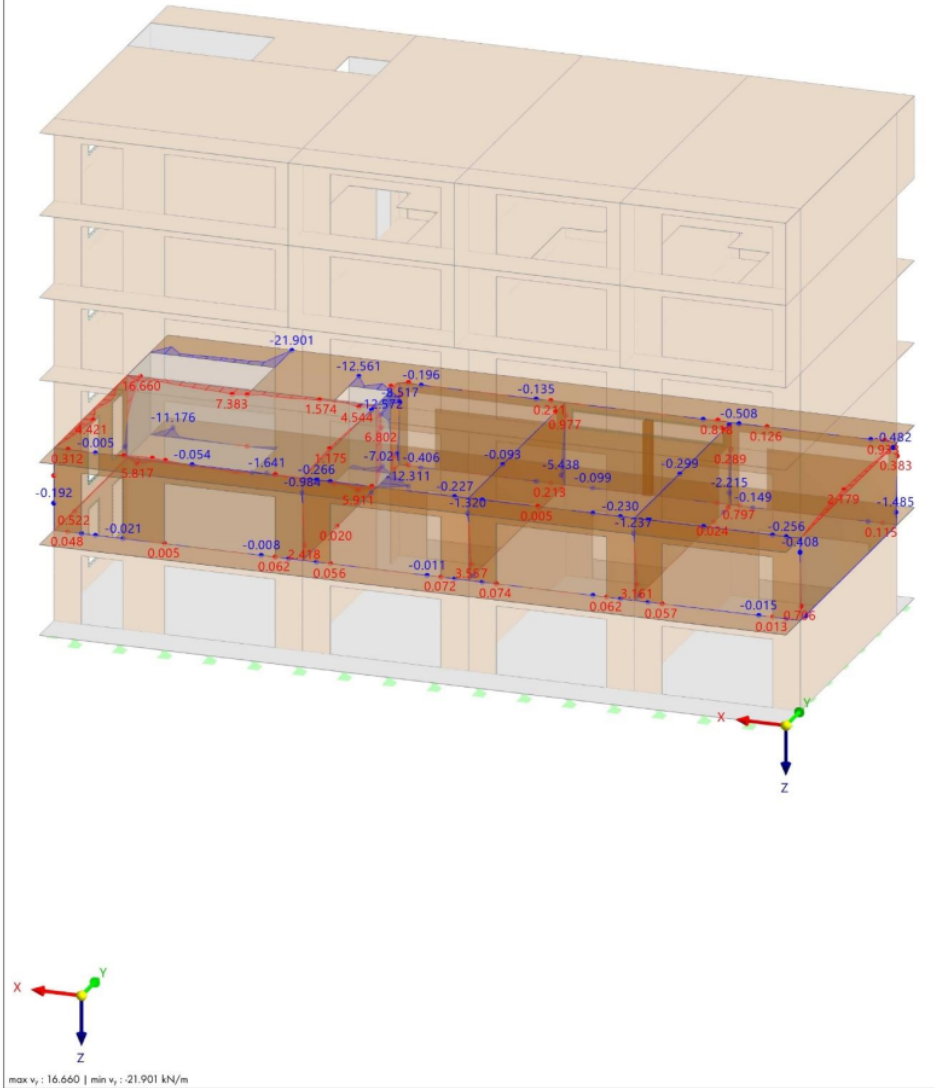

Marija Gulam



Model:
diplomski_zgradaB

Date: 21.8.2024 Page: 24/33
Sheet: 1

MODEL

6.9 CO10: FORCES V_z IN AXONOMETRIC DIRECTION

Static Analysis

Visibility mode
CO10 - 1.35 * IC1 + 1.35 * IC2 + 1.50 * IC3 + 1.50 * IC5 + 0.75 * IC4 + 0.90 * IC6
Static Analysis
Forces v_z [kN/m]

In Axonometric Direction

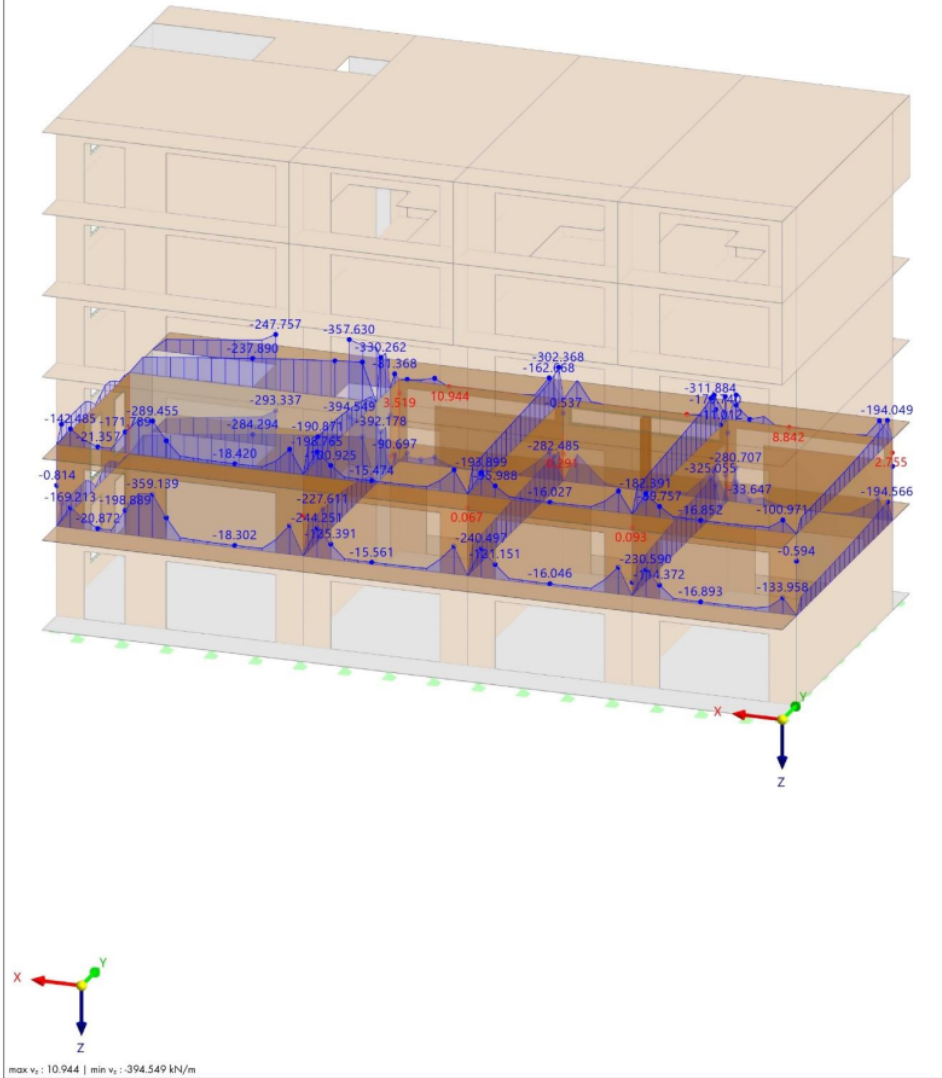

Marija Gulam



Model: diplomski_zgradaB

Date: 21.8.2024 Page: 25/33
Sheet: 1

MODEL

7 Modal Analysis Results

7.1 NATURAL FREQUENCIES

Modal Analysis

Mode No.	Eigenvalue λ [1/s ²]	Angular Frequency ω [rad/s]	Natural Frequency f [Hz]	Natural Period T [s]
1	568.440	23.842	3.795	0.264
2	856.992	29.274	4.659	0.215
3	1399.371	37.408	5.954	0.168
4	5169.051	71.896	11.443	0.087
5	6226.656	78.909	12.559	0.080
6	8885.000	94.250	15.002	0.067
7	9167.025	95.745	15.238	0.066
8	9763.791	98.812	15.726	0.064
9	9832.110	99.157	15.781	0.063
10		99.829	15.888	0.063
11	10107.339	100.535	16.001	0.062
12	10263.613	101.309	16.124	0.062
13	10331.877	101.646	16.177	0.062
14	10356.832	101.769	16.197	0.062
15	10387.465	101.919	16.221	0.062
16	10399.076	101.976	16.230	0.062
17	10445.550	102.203	16.266	0.061
18	11336.086	106.471	16.945	0.059
19	11534.755	107.400	17.093	0.059
20	11616.367	107.779	17.154	0.058
21	11717.925	108.249	17.228	0.058
22	15355.050	123.915	19.722	0.051
23	16992.123	130.354	20.746	0.048
24	17656.838	132.879	21.148	0.047
25	18240.354	135.057	21.495	0.047
26	18924.761	137.567	21.895	0.046
27			22.063	0.045
28	19318.096	138.989	22.121	0.045
29	19357.853	139.133	22.144	0.045
30	19531.217	139.754	22.243	0.045

7.2 EFFECTIVE MODAL MASSES

Modal Analysis

Mode No.	Modal Mass M [kg]	Transl. Eff. Modal Mass [kg]		Rotat. Eff. Modal Mass [kgm ²]			Transl. Eff. Modal Mass Factor [-]			Rotat. Eff. Modal Mass Factor [-]			
		m_{mx}	m_{my}	$m_{\theta x}$	$m_{\theta y}$	$m_{\theta z}$	f_{mx}	f_{my}	f_{mz}	$f_{\theta x}$	$f_{\theta y}$	$f_{\theta z}$	
1	161851.0	13180.7	572597.0	0.0	4921980.0	114755.00	7450500.00	0.015	0.666	0.000	0.201	0.005	0.107
2	101741.2	73688.4	85463.8	0.0	787526.0	614152.00	39465500.00	0.086	0.099	0.000	0.032	0.025	0.589
3	194373.2	534602.0	222.5	0.0	370.74	5937580.00	6463210.00	0.622	0.000	0.000	0.000	0.242	0.093
4	33728.3	24197.9	71226.8	0.0	7581220.00	1616450.00	2103810.00	0.028	0.083	0.000	0.309	0.066	0.030
5	68761.6	48429.8	52671.7	0.0	4571370.00	3733120.00	2021060.00	0.056	0.061	0.000	0.186	0.152	0.029
6	386.1	400.3	5.6	0.0	790.38	5966.56	1105.47	0.000	0.000	0.000	0.000	0.000	0.000
7	955.5	36860.9	1866.4	0.0	85217.00	2373580.00	3835670.00	0.043	0.002	0.000	0.003	0.097	0.555
8	185.6	168.2	396.4	0.0	33360.20	18096.90	36168.10	0.000	0.000	0.000	0.001	0.001	0.001
9	196.6	15.5	133.2	0.0	12361.10	287.08	57358.40	0.000	0.000	0.000	0.001	0.000	0.001
10	134.1	220.0	44.9	0.0	4875.01	25690.80	133.86	0.000	0.000	0.000	0.000	0.001	0.000
11	735.2	9096.7	1061.0	0.0	20612.50	620169.00	1060200.00	0.011	0.001	0.000	0.001	0.021	0.015
12	206.6	225.7	481.0	0.0	22257.90	14608.80	23361.40	0.000	0.001	0.000	0.001	0.001	0.000
13	314.0	1700.1	283.8	0.0	30456.20	94145.90	447485.00	0.002	0.000	0.000	0.001	0.004	0.006
14	118.7	36.4	13.5	0.0	1095.40	2094.65	28695.60	0.000	0.000	0.000	0.000	0.000	0.000
15	158.2	739.9	48.5	0.0	878.73	46328.40	138368.00	0.001	0.000	0.000	0.000	0.002	0.002
16	117.4	0.0	62.3	0.0	5332.81	1.44	4.13	0.000	0.000	0.000	0.000	0.000	0.000
17	258.7	171.4	159.0	0.0	19937.20	9313.53	26681.10	0.000	0.000	0.000	0.001	0.000	0.000
18	1350.1	2695.6	108.3	0.0	42544.30	149558.00	66039.50	0.003	0.000	0.000	0.002	0.006	0.001
19	257.6	18270.7	275.1	0.0	14764.80	1435140.00	8119.06	0.021	0.000	0.000	0.001	0.058	0.000
20	197.0	2739.9	169.2	0.0	18469.80	207230.00	296.06	0.003	0.000	0.000	0.000	0.008	0.000
21	446.4	11119.3	1.3	0.0	4352.77	1022390.00	84078.00	0.013	0.000	0.000	0.000	0.042	0.001
22	6451.8	2.6	28969.4	0.0	2197730.00	4032.29	57853.70	0.000	0.034	0.000	0.090	0.000	0.001
23	4933.1	6334.5	655.8	0.0	59415.80	265057.00	70210.00	0.007	0.001	0.000	0.002	0.011	0.001
24	4969.1	2840.4	287.0	0.0	31344.20	619495.00	105069.00	0.003	0.000	0.000	0.001	0.025	0.002
25	603.0	2486.5	230.1	0.0	23595.70	207015.00	1013010.00	0.003	0.000	0.000	0.001	0.008	0.015
26	575.8	13.0	321.2	0.0	17388.30	735.08	84073.90	0.000	0.000	0.000	0.001	0.000	0.001
27	115.7	5.1	14.2	0.0	1317.41	264.65	267.36	0.000	0.000	0.000	0.000	0.000	0.000
28	88.6	0.4	4.9	0.0	738.09	95.19	590.72	0.000	0.000	0.000	0.000	0.000	0.000
29	95.6	5.0	25.7	0.0	4206.81	158.82	175.61	0.000	0.000	0.000	0.000	0.000	0.000
30	301.1	0.3	73.1	0.0	6860.14	22.49	5256.71	0.000	0.000	0.000	0.000	0.000	0.000
Σ	584606.8	790248.0	817863.0	0.0	2052300.00	1903750.00	64652800.00	0.919	0.952	0.000	0.836	0.776	0.932
Σ_{λ}		859518.0	859518.0	0.0	24545400.00	24545400.00	69361800.00						
%		91.94 %	95.15 %		83.61 %	77.56 %	93.21 %						



Marija Gulam



Model:
diplomski_zgradaB

Date: 21.8.2024 Page: 26/33
Sheet: 1

RESULTS

7.3 EFFECTIVE MODAL MASSES - EQUIVALENT MASS PER UNIT LENGTH

Modal Analysis

Mode No.	Modal Mass M [kg]
■ LC9 - Potres	
1	161851.0
2	101741.2
3	194373.2
4	33728.3
5	68761.6
6	386.1
7	955.5
8	165.6
9	196.6
10	134.1
11	735.2
12	206.6
13	314.0
14	118.7
15	158.2
16	117.4
17	258.7
18	1350.1
19	257.6
20	197.0
21	446.4
22	6451.8
23	4933.1
24	4969.1
25	603.0
26	575.8
27	115.7
28	88.6
29	95.6
30	301.1
Σ	584606.8
%	



Marija Gulam



Model:
diplomski_zgradaB

Date: 21.8.2024 Page: 27/33
Sheet: 1

MODEL

7.4 LC9: MODE SHAPE |U|, IN AXONOMETRIC DIRECTION

Modal Analysis

Visibility mode
LC9 - Potres
Modal Analysis
Mode No. 1 - 3.795 Hz
Normalized Displacements |u|

In Axonometric Direction

Mode Shape u [-]	
1.00000	1.62 %
0.90909	3.24 %
0.81818	5.02 %
0.72727	7.01 %
0.63636	8.16 %
0.54545	10.87 %
0.45455	11.19 %
0.36364	13.73 %
0.27273	11.88 %
0.18182	15.55 %
0.09091	11.73 %
0.00000	

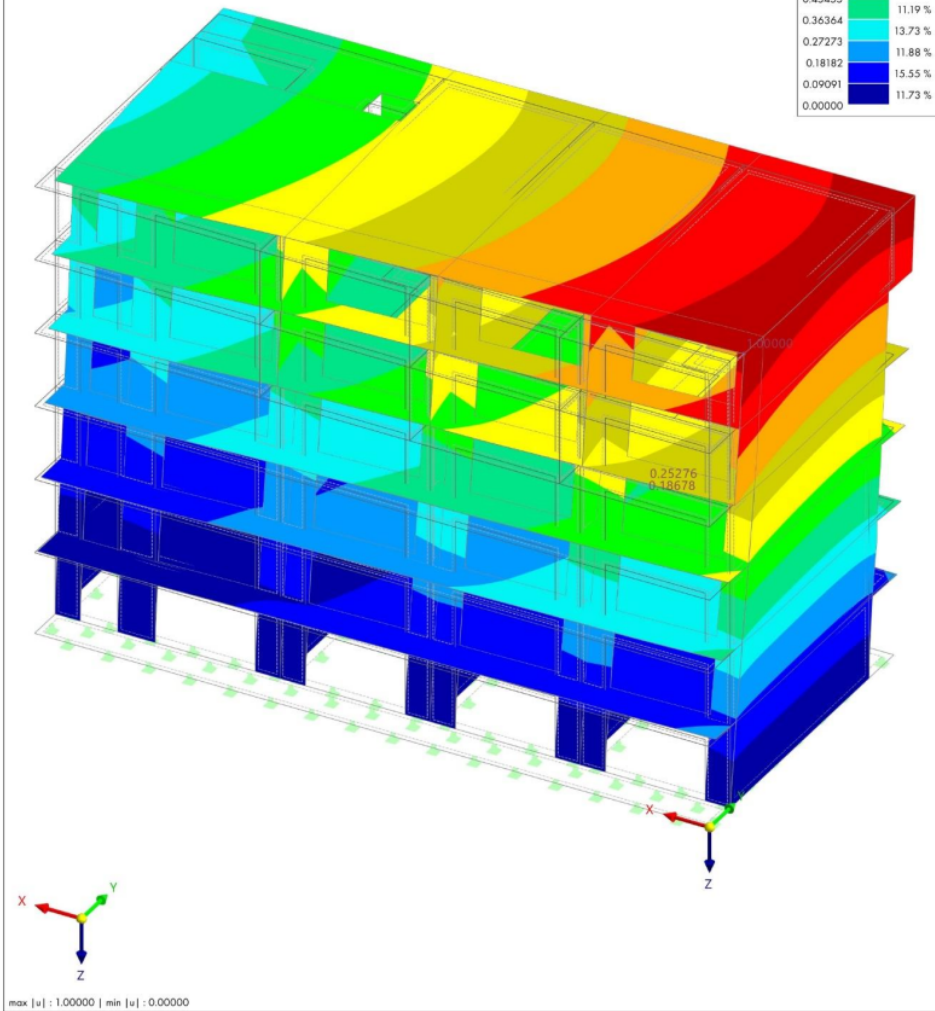

Marija Gulam



Model:
diplomski_zgradaB

Date: 21.8.2024 Page: 28/33
Sheet: 1

MODEL

7.5 LC9: MODE SHAPE |U|, IN AXONOMETRIC DIRECTION

Modal Analysis

Visibility mode
LC9 - Potres
Modal Analysis
Mode No. 2 - 4.659 Hz
Normalized Displacements |u|

In Axonometric Direction

Mode Shape u [-]	
1.00000	0.14 %
0.90909	0.69 %
0.81818	1.70 %
0.72727	2.96 %
0.63636	5.02 %
0.54545	8.12 %
0.45455	10.37 %
0.36364	12.34 %
0.27273	16.23 %
0.18182	18.86 %
0.09091	23.57 %
0.00000	

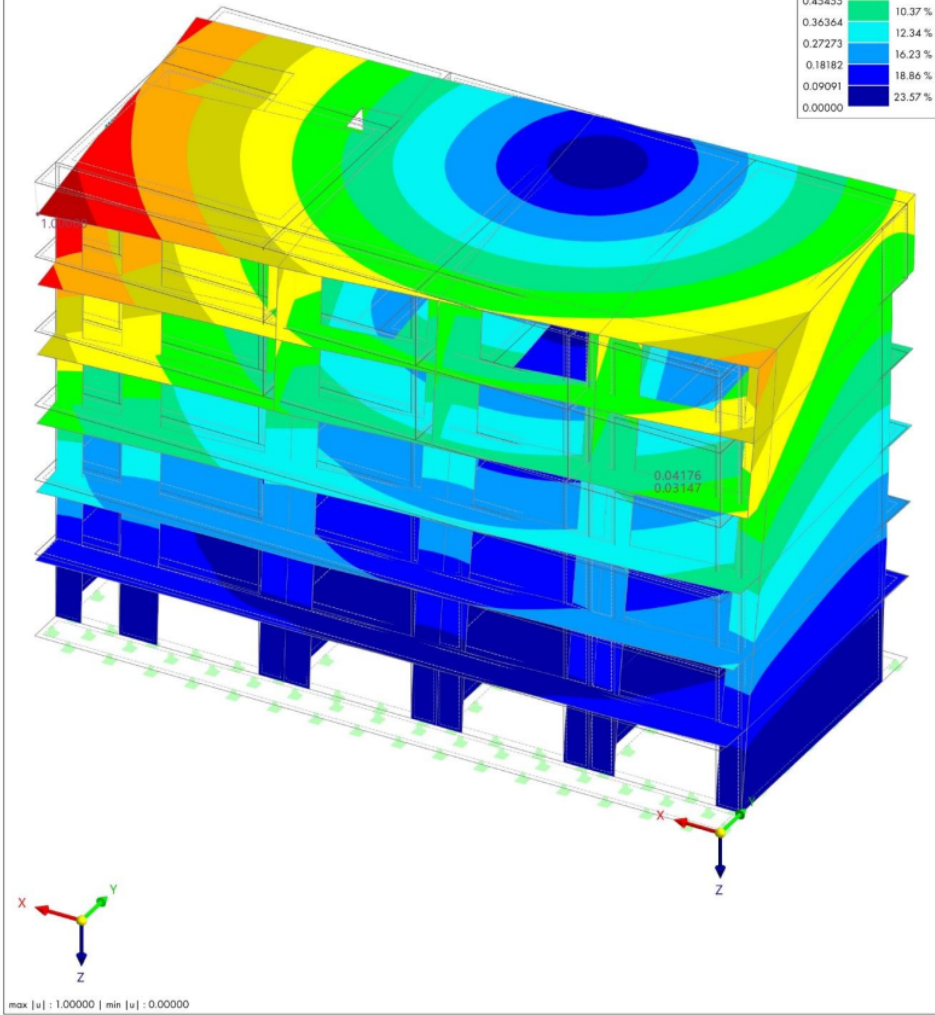

Marija Gulam



Model:
diplomski_zgradaB

Date: 21.8.2024 Page: 29/33
Sheet: 1

MODEL

7.6 LC9: MODE SHAPE |U|, IN AXONOMETRIC DIRECTION

Modal Analysis

Visibility mode
LC9 - Potres
Modal Analysis
Mode No. 3 - 5.954 Hz
Normalized Displacements |u|

In Axonometric Direction

Mode Shape u [-]	
1.00000	1.42 %
0.90909	3.49 %
0.81818	6.20 %
0.72727	8.48 %
0.63636	10.35 %
0.54545	9.57 %
0.45455	10.77 %
0.36364	10.26 %
0.27273	12.09 %
0.18182	12.03 %
0.09091	15.35 %
0.00000	

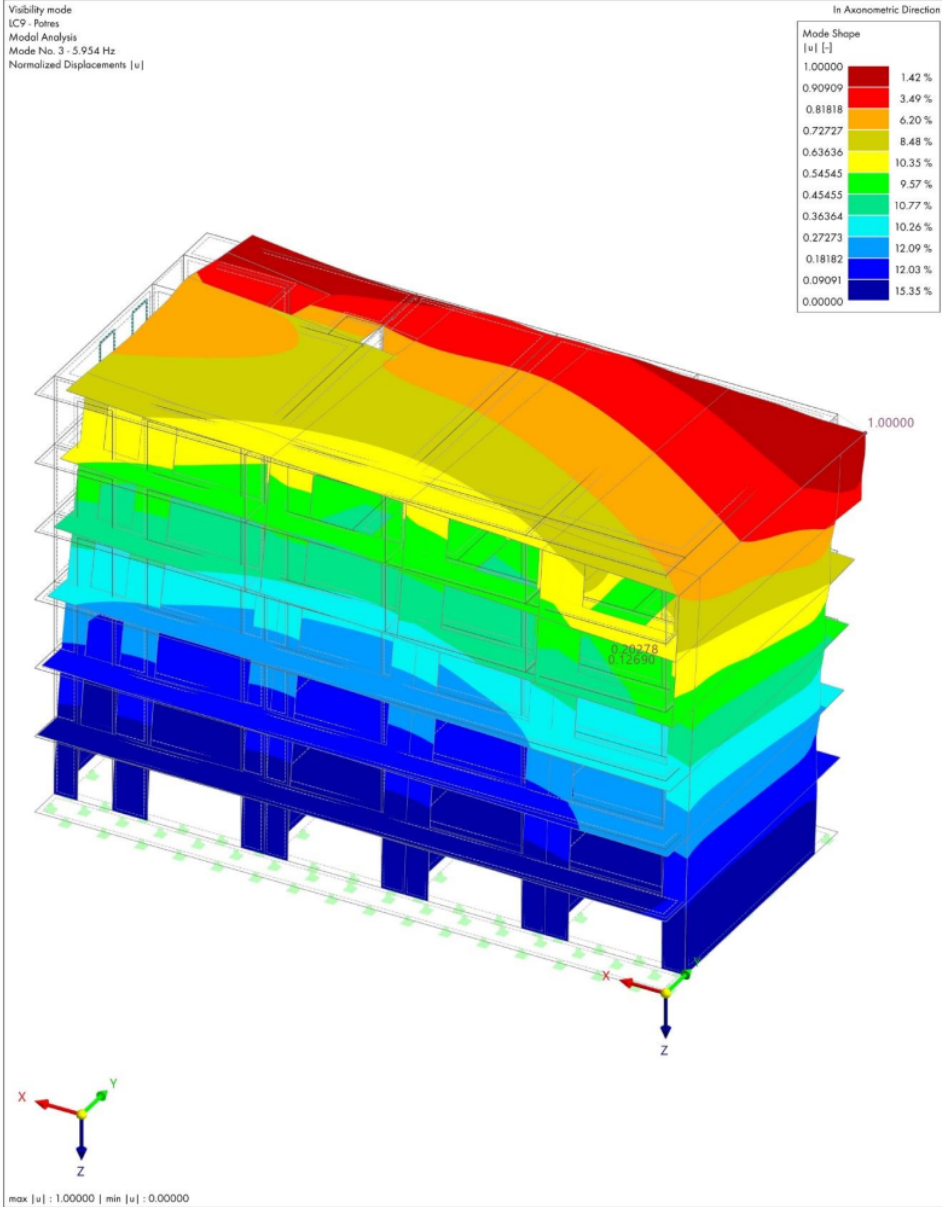

Marija Gulam



Model: diplomski_zgradaB

Date: 21.8.2024 Page: 30/33
Sheet: 1

MODEL

7.7 LC9: MODE SHAPE |U|, IN AXONOMETRIC DIRECTION

Modal Analysis

Visibility mode
LC9 - Potres
Modal Analysis
Mode No. 4 - 11.443 Hz
Normalized Displacements |u|

In Axonometric Direction

Mode Shape u [-]	
1.00000	0.02 %
0.90909	0.02 %
0.81818	0.05 %
0.72727	0.11 %
0.63636	0.20 %
0.54545	0.49 %
0.45455	6.67 %
0.36364	15.81 %
0.27273	24.22 %
0.18182	29.28 %
0.09091	23.13 %
0.00000	

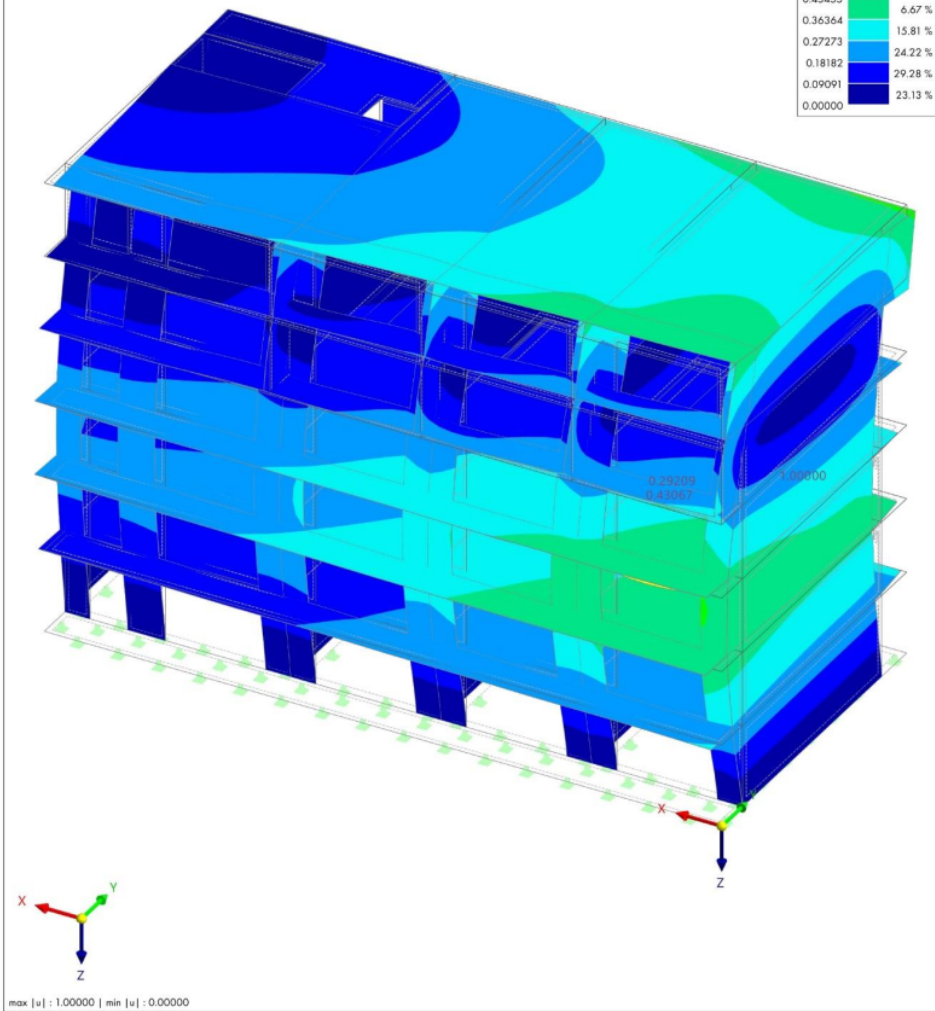

Marija Gulam



Model:
diplomski_zgradaB

Date: 21.8.2024 Page: 31/33
Sheet: 1

MODEL

7.8 LC9: MODE SHAPE |U|, IN AXONOMETRIC DIRECTION

Modal Analysis

Visibility mode
LC9 - Potres
Modal Analysis
Mode No. 5 - 12.559 Hz
Normalized Displacements |u|

In Axonometric Direction

Mode Shape u [-]	
1.00000	0.01 %
0.90909	0.02 %
0.81818	0.04 %
0.72727	0.10 %
0.63636	0.89 %
0.54545	6.74 %
0.45455	14.88 %
0.36364	16.98 %
0.27273	24.73 %
0.18182	22.48 %
0.09091	13.13 %
0.00000	

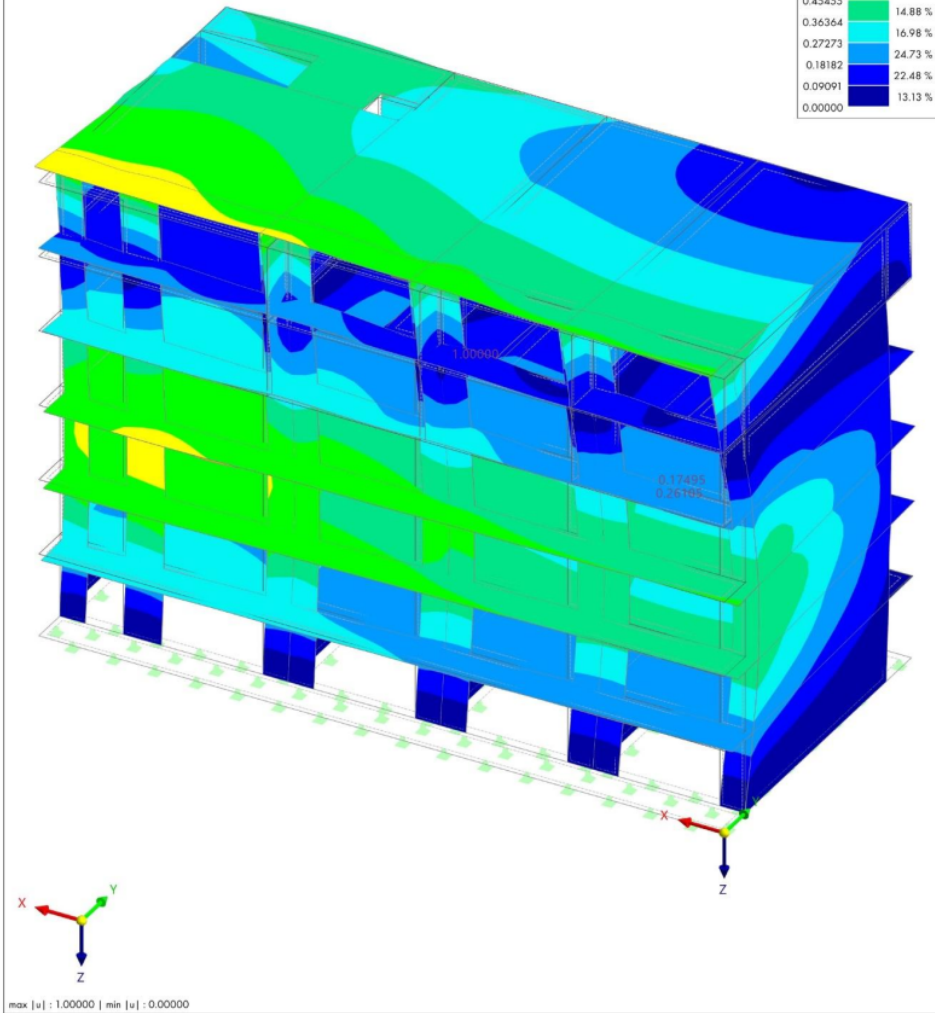

Marija Gulam



Model: diplomski_zgradaB

Date: 21.8.2024 Page: 32/33
Sheet: 1

MODEL

F LC10: ENVELOPE VALUES - MAX AND MIN VALUES, GLOBAL DEFORMATIONS [U], IN AXONOMETRIC DIRECTION

Spectral Analysis

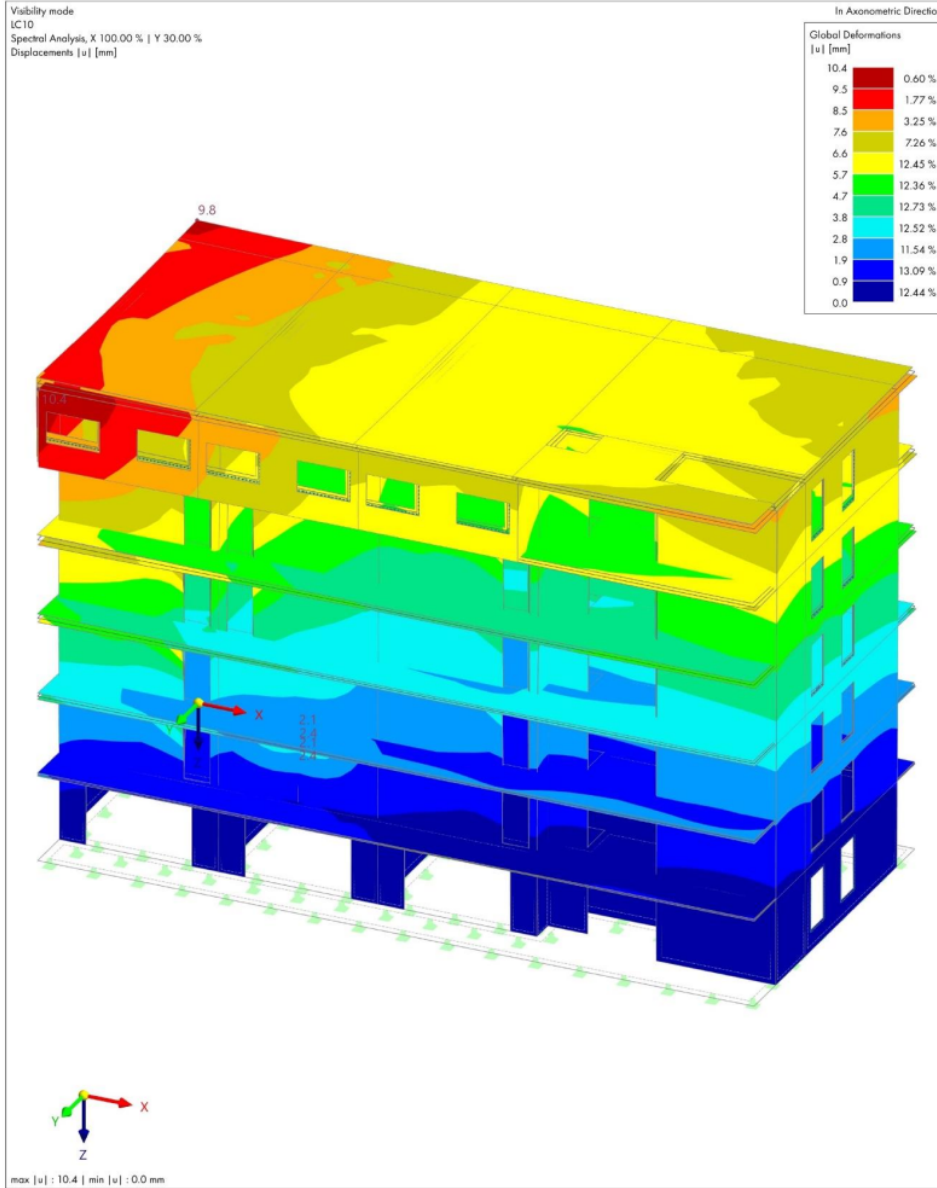

Marija Gulam



Model:
diplomski_zgradaB

Date: 21.8.2024 Page: 33/33
Sheet: 1

MODEL

G LC10: ENVELOPE VALUES - MAX AND MIN VALUES, GLOBAL DEFORMATIONS [U], IN AXONOMETRIC DIRECTION

Spectral Analysis

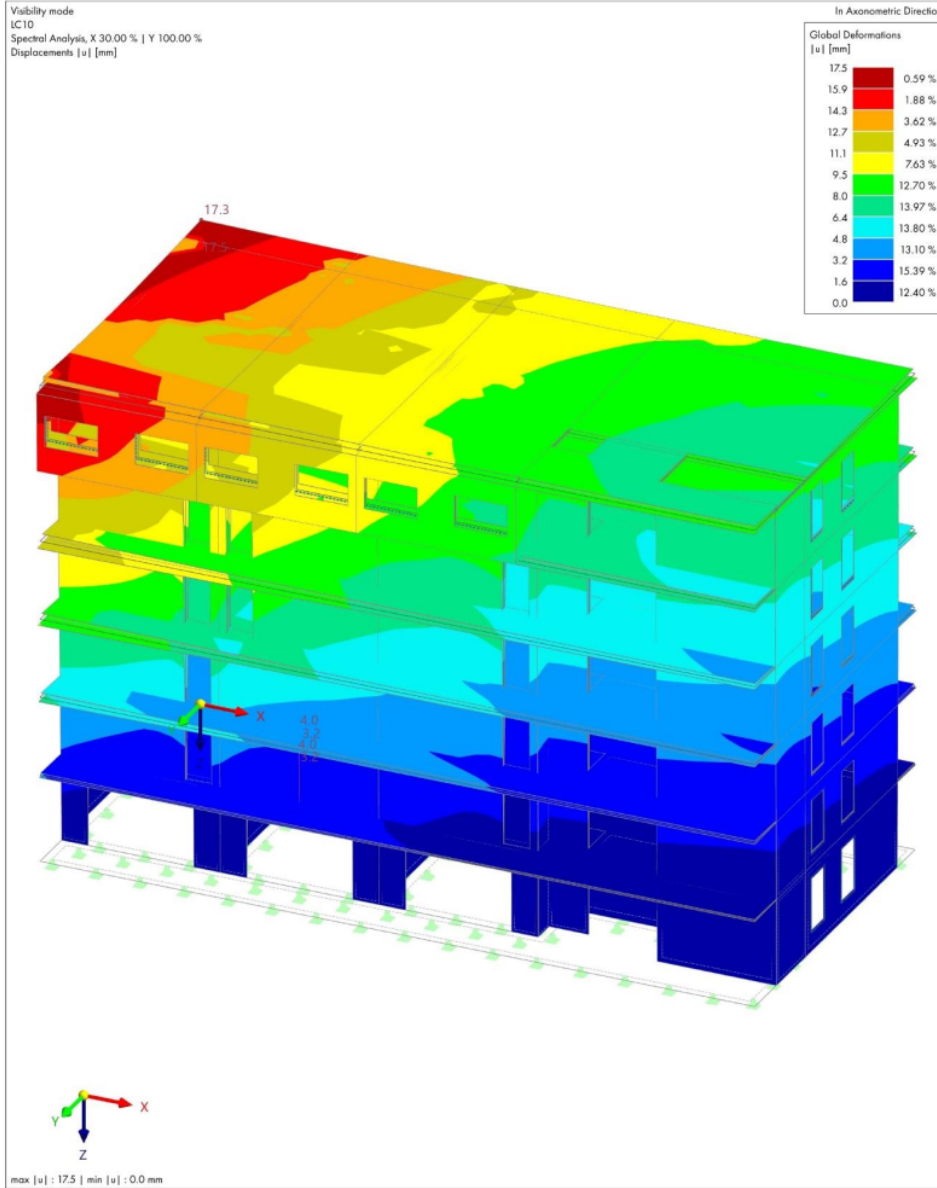

2.5 Dimenzioniranje nosivih dijelova konstrukcije

Dimenzioniranje nosivih dijelova konstrukcije napravljeno je u software-ima *Dlubal RFEM* i *Calculatis*, a provedeno je za karakteristične elemente mjerodavne za cijelu konstrukciju.

Odrađeno je dimenzioniranje na granična stanja nosivosti i uporabljivosti te su odrađene provjere za požar i vibracije.

Kontinuirane ploče u zgradi A su na 5 raspona, dok su u zgradi B na 3 raspona, dobivene su jednake debljine za obe zgrade te je prikazano dimenzioniranje krovne ploče zgrade A i međukatne konstrukcije zgrade B.

Ploče na velikim rasponima bile su izazovne za dimenzioniranje te je isprobano više mogućih varijanti. Jedno od isprobanih rješenja bilo je sustav ploče s gređicama, ali zbog prevelike visine presjeka nije zadovoljilo minimalnu svijetlu visinu etaže. Kao optimalno rješenje odabrana je CLT ploča s čeličnom gredom, na taj način je dobivena kontinuirana ploča preko 2 raspona.

Kao mjerodavni zid odabran je zid s najvećim otvorom u prizemlju konstrukcije.

2.5.1 Krovna ploča

2.5.1.1 Kontinuirano oslonjena ploča



Marija Gulam
University of Zagreb,
Faculty of Civil
Engineering

1/15

System

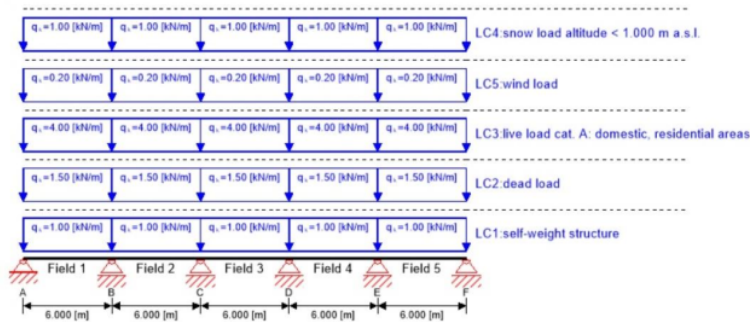

Global utilization ratio

85%

ULS 42% ULS Fire 21% SLS 85% Vibration 73% Support -1%

Product data

Section: CLT 200 L5s

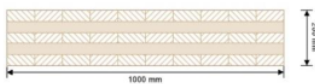

Layer	Thickness	Orientation	Material
1	40.0 mm	0°	C24 spruce ETA (2022)
2	40.0 mm	90°	C24 spruce ETA (2022)
3	40.0 mm	0°	C24 spruce ETA (2022)
4	40.0 mm	90°	C24 spruce ETA (2022)
5	40.0 mm	0°	C24 spruce ETA (2022)
t_{CLT}	200.0 mm		



Section Fire: CLT 200 L5s

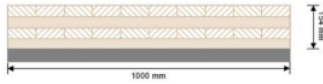

Layer	Thickness	Orientation	Material		
1	40.0 mm	0°	C24 spruce ETA (2022)		
2	40.0 mm	90°	C24 spruce ETA (2022)		
3	40.0 mm	0°	C24 spruce ETA (2022)		
4	34.0 mm	90°	C24 spruce ETA (2022)		
t_{CLT}	154.0 mm				
Time	60 min				
k_0	d_0	$d_{char,0,h}$	$d_{ef,h}$	$d_{char,0,v}$	$d_{ef,v}$
[-]	[mm]	[mm]	[mm]	[mm]	[mm]
1	7	39.0	46.0	0.0	0.0

Fire resistance class: R 60

Fire protection layering:
no additional fire protection

Material values

Material	$f_{m,k}$	$f_{t,0,k}$	$f_{t,90,k}$	$f_{c,0,k}$	$f_{c,90,k}$	$f_{v,k}$	$f_{t,k \min}$	$E_{0,mean}$	G_{mean}	$G_{v,mean}$
	[N/mm ²]	[N/mm ²]	[N/mm ²]	[N/mm ²]	[N/mm ²]	[N/mm ²]	[N/mm ²]	[N/mm ²]	[N/mm ²]	[N/mm ²]
C24 spruce ETA (2022)	24.00	14.00	0.12	21.00	2.50	4.00	1.25	12,000.00	690.00	50.00

Load

Load case groups

Load case category	Type	Duration	K_{mod}	γ_{ref}	γ_{sup}	ψ_0	ψ_1	ψ_2
LC1 self-weight structure	G	permanent	0.6	1	1.35	1	1	1
LC2 dead load	G	permanent	0.6	1	1.35	1	1	1
LC3 live load cat. A: domestic, residential areas	Q	medium term	0.8	0	1.5	0.7	0.5	0.3
LC4 snow load altitude < 1.000 m a.s.l.	Q	short term	0.9	0	1.5	0.5	0.2	0
LC5 wind load	Q	short term	0.9	0	1.5	0.6	0.2	0

LC1:self-weight structure



continuous load

Field	Load at start [kN/m]
1	1.00
2	1.00
3	1.00
4	1.00
5	1.00

LC2:dead load

continuous load

Field	Load at start [kN/m]
1	1.50
2	1.50
3	1.50
4	1.50
5	1.50

LC3:live load cat. A: domestic, residential areas

continuous load

Field	Load at start [kN/m]
1	4.00
2	4.00
3	4.00
4	4.00
5	4.00



LC4:snow load altitude < 1.000 m a.s.l.

continuous load

Field	Load at start [kN/m]
1	1.00
2	1.00
3	1.00
4	1.00
5	1.00

LC5:wind load

continuous load

Field	Load at start [kN/m]
1	0.20
2	0.20
3	0.20
4	0.20
5	0.20

ULS Combinations

	Combination rule
LCO1	$1.35/1.00 * LC1 + 1.35/1.00 * LC2$
LCO2	$1.35/1.00 * LC1 + 1.35/1.00 * LC2 + 1.50/0.00 * LC3$
LCO3	$1.35/1.00 * LC1 + 1.35/1.00 * LC2 + 1.50/0.00 * LC3 + 1.50/0.00 * 0.50 * LC4$
LCO4	$1.35/1.00 * LC1 + 1.35/1.00 * LC2 + 1.50/0.00 * LC3 + 1.50/0.00 * 0.50 * LC4 + 1.50/0.00 * 0.60 * LC5$
LCO5	$1.35/1.00 * LC1 + 1.35/1.00 * LC2 + 1.50/0.00 * LC4$
LCO6	$1.35/1.00 * LC1 + 1.35/1.00 * LC2 + 1.50/0.00 * LC4 + 1.50/0.00 * 0.70 * LC3$



ULS Combinations

Combination rule	
LCO7	$1.35/1.00 * LC1 + 1.35/1.00 * LC2 + 1.50/0.00 * LC4 + 1.50/0.00 * 0.70 * LC3 + 1.50/0.00 * 0.60 * LC5$
LCO8	$1.35/1.00 * LC1 + 1.35/1.00 * LC2 + 1.50/0.00 * LC5$
LCO9	$1.35/1.00 * LC1 + 1.35/1.00 * LC2 + 1.50/0.00 * LC5 + 1.50/0.00 * 0.70 * LC3$
LCO10	$1.35/1.00 * LC1 + 1.35/1.00 * LC2 + 1.50/0.00 * LC5 + 1.50/0.00 * 0.70 * LC3 + 1.50/0.00 * 0.50 * LC4$

ULS Combinations Fire

Combination rule	
LCO11	$1.00/1.00 * LC1 + 1.00/1.00 * LC2$
LCO12	$1.00/1.00 * LC1 + 1.00/1.00 * LC2 + 1.00/0.00 * 0.30 * LC3$
LCO13	$1.00/1.00 * LC1 + 1.00/1.00 * LC2 + 1.00/0.00 * 0.30 * LC3 + 1.00/0.00 * 0.00 * LC4$
LCO14	$1.00/1.00 * LC1 + 1.00/1.00 * LC2 + 1.00/0.00 * 0.30 * LC3 + 1.00/0.00 * 0.00 * LC4 + 1.00/0.00 * 0.00 * LC5$
LCO15	$1.00/1.00 * LC1 + 1.00/1.00 * LC2 + 1.00/0.00 * 0.00 * LC4$
LCO16	$1.00/1.00 * LC1 + 1.00/1.00 * LC2 + 1.00/0.00 * 0.00 * LC4 + 1.00/0.00 * 0.30 * LC3$
LCO17	$1.00/1.00 * LC1 + 1.00/1.00 * LC2 + 1.00/0.00 * 0.00 * LC4 + 1.00/0.00 * 0.30 * LC3 + 1.00/0.00 * 0.00 * LC5$
LCO18	$1.00/1.00 * LC1 + 1.00/1.00 * LC2 + 1.00/0.00 * 0.00 * LC5$
LCO19	$1.00/1.00 * LC1 + 1.00/1.00 * LC2 + 1.00/0.00 * 0.00 * LC5 + 1.00/0.00 * 0.30 * LC3$
LCO20	$1.00/1.00 * LC1 + 1.00/1.00 * LC2 + 1.00/0.00 * 0.00 * LC5 + 1.00/0.00 * 0.30 * LC3 + 1.00/0.00 * 0.00 * LC4$

SLS Characteristic Combination

Combination rule	
LCO21	$1.00/1.00 * LC1 + 1.00/1.00 * LC2$
LCO22	$1.00/1.00 * LC1 + 1.00/1.00 * LC2 + 1.00/0.00 * LC3 + 1.00/0.00 * 0.50 * LC4 + 1.00/0.00 * 0.60 * LC5$
LCO23	$1.00/1.00 * LC1 + 1.00/1.00 * LC2 + 1.00/0.00 * LC4 + 1.00/0.00 * 0.70 * LC3 + 1.00/0.00 * 0.60 * LC5$
LCO24	$1.00/1.00 * LC1 + 1.00/1.00 * LC2 + 1.00/0.00 * LC5 + 1.00/0.00 * 0.70 * LC3 + 1.00/0.00 * 0.50 * LC4$

SLS Quasi-permanent Combination

Combination rule	
LCO25	$1.00/1.00 * LC1 + 1.00/1.00 * LC2$
LCO26	$1.00/1.00 * LC1 + 1.00/1.00 * LC2 + 1.00/0.00 * 0.30 * LC3 + 1.00/0.00 * 0.00 * LC4 + 1.00/0.00 * 0.00 * LC5$
LCO27	$1.00/1.00 * LC1 + 1.00/1.00 * LC2 + 1.00/0.00 * 0.00 * LC4 + 1.00/0.00 * 0.30 * LC3 + 1.00/0.00 * 0.00 * LC5$

© 2024 - Calculatis by Stora Enso - Version 7.10.0
Any use of results of the software is only allowed, if the results have been verified and approved regarding completeness and correctness by a project structural/building physics engineer. For more information see the Terms of Use.



SLS Quasi-permanent Combination

Combination rule

LCO28 1.00/1.00 * LC1 + 1.00/1.00 * LC2 + 1.00/0.00 * 0.00 * LC5 + 1.00/0.00 * 0.30 * LC3 + 1.00/0.00 * 0.00 * LC4

Ultimate limit state (ULS) - design results

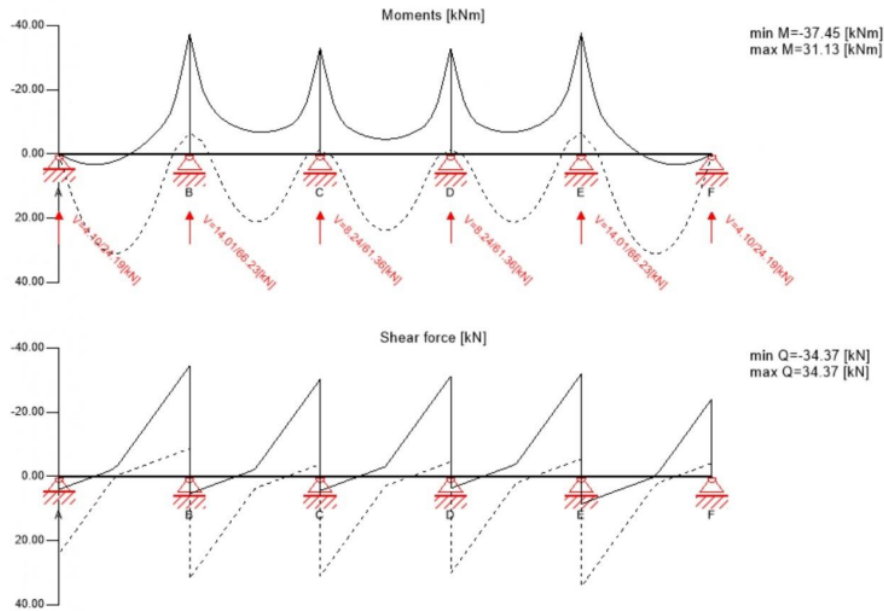

ULS Flexural design

Field	Dist.	$f_{m,k}$	γ_m	k_{mod}	$k_{sys,y}$	$f_{m,y,d}$	$M_{y,d}$	$\sigma_{m,y,d}$	Ratio	
	[m]	[N/mm ²]	[-]	[-]	[-]	[N/mm ²]	[kNm]	[N/mm ²]		
1	6.0	24.00	1.25	0.80	1.10	16.90	-37.45	7.09	42%	LCO2
2	0.0	24.00	1.25	0.80	1.10	16.90	-37.45	7.09	42%	LCO2
3	0.0	24.00	1.25	0.80	1.10	16.90	-32.89	6.23	37%	LCO2
4	6.0	24.00	1.25	0.80	1.10	16.90	-37.45	7.09	42%	LCO2
5	0.0	24.00	1.25	0.80	1.10	16.90	-37.45	7.09	42%	LCO2

© 2024 - Calculatis by Stora Enso - Version 7.10.0
Any use of results of the software is only allowed, if the results have been verified and approved regarding completeness and correctness by a project structural/building physics engineer. For more information see the Terms of Use.



ULS Shear analysis

Field	Dist.	$f_{v,k}$	γ_m	k_{nod}	$f_{v,d}$	V_d	$\tau_{v,d}$	Ratio	
	[m]	[N/mm ²]	[-]	[-]	[N/mm ²]	[kN]	[N/mm ²]		
1	6.0	4.00	1.25	0.80	2.56	-34.37	0.22	9%	LCO2
2	0.0	4.00	1.25	0.80	2.56	31.87	0.21	8%	LCO2
3	6.0	4.00	1.25	0.80	2.56	-31.14	0.20	8%	LCO2
4	6.0	4.00	1.25	0.80	2.56	-31.87	0.21	8%	LCO2
5	0.0	4.00	1.25	0.80	2.56	34.37	0.22	9%	LCO2

ULS Rolling shear

Field	Dist.	$f_{v,k}$	γ_m	k_{nod}	$f_{r,d}$	V_d	$\tau_{r,d}$	Ratio	
	[m]	[N/mm ²]	[-]	[-]	[N/mm ²]	[kN]	[N/mm ²]		
1	6.0	1.05	1.25	0.80	0.67	-34.37	0.21	31%	LCO2
2	0.0	1.05	1.25	0.80	0.67	31.87	0.19	29%	LCO2
3	6.0	1.05	1.25	0.80	0.67	-31.14	0.19	28%	LCO2
4	6.0	1.05	1.25	0.80	0.67	-31.87	0.19	29%	LCO2
5	0.0	1.05	1.25	0.80	0.67	34.37	0.21	31%	LCO2

Stress diagram

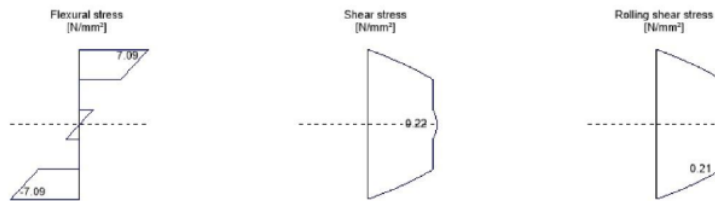



Flexural stress analysis				
$M_{y,d}$	-37.45	kNm	$f_{m,k}$	24.00 N/mm ²
$M_{z,d}$	0.00	kNm	$f_{m,k,z}$	24.00 N/mm ²
$N_{t,d}$	0.00	kN	γ_m	1.25 -
			k_{mod}	0.80 -
			$k_{sys,y}$	1.10 -
			$k_{h,m,y}$	1.00 -
			$k_{h,m,z}$	1.00 -
			k_i	1.00 -
$\sigma_{t,d}$	0.00	N/mm ²	$f_{t,d}$	8.96 N/mm ²
$\sigma_{m,y,d}$	7.09	N/mm ²	$f_{m,y,d}$	16.90 N/mm ²
$\sigma_{m,z,d}$	0.00	N/mm ² <	$f_{m,z,d}$	0.00 N/mm ² ✓
Utilization ratio				42%

Shear stress analysis				
V_{d}	-34.37	kN	$f_{v,k}$	4.00 N/mm ²
			γ_m	1.25 -
			k_{mod}	0.80 -
			$k_{h,v}$	0.00 -
$\tau_{v,d}$	0.22	N/mm ² <	$f_{v,d}$	2.56 N/mm ² ✓
Utilization ratio				9%

Rolling shear analysis				
V_{d}	-34.37	kN	$f_{r,k}$	1.05 N/mm ²
			γ_m	1.25 -
			k_{mod}	0.80 -
$\tau_{r,d}$	0.21	N/mm ² <	$f_{r,d}$	0.67 N/mm ² ✓
Utilization ratio				31%



Ultimate limit state (ULS) fire design - results

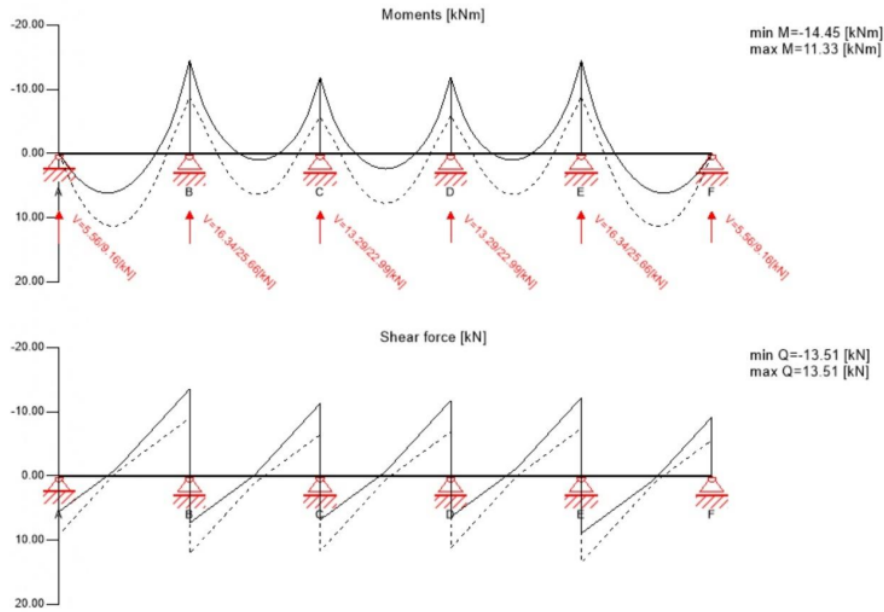

ULS Fire Flexural design

Field	Dist. [m]	$f_{m,k}$ [N/mm ²]	γ_m [-]	k_{nod} [-]	$k_{sys,y}$ [-]	k_{fi} [-]	$f_{m,y,d}$ [N/mm ²]	$M_{y,d}$ [kNm]	$\sigma_{m,y,d}$ [N/mm ²]	Ratio	
1	6.0	24.00	1.00	1.00	1.10	1.15	30.36	-14.45	6.25	21%	LCO12
2	0.0	24.00	1.00	1.00	1.10	1.15	30.36	-14.45	6.25	21%	LCO12
3	0.0	24.00	1.00	1.00	1.10	1.15	30.36	-11.86	5.13	17%	LCO12
4	6.0	24.00	1.00	1.00	1.10	1.15	30.36	-14.45	6.25	21%	LCO12
5	0.0	24.00	1.00	1.00	1.10	1.15	30.36	-14.45	6.25	21%	LCO12

© 2024 - Calculatis by Stora Enso - Version 7.10.0
Any use of results of the software is only allowed, if the results have been verified and approved regarding completeness and correctness by a project structural/building physics engineer. For more information see the Terms of Use.



ULS Fire Shear analysis

Field	Dist.	$f_{v,k}$	γ_m	k_{mod}	k_{ft}	$f_{v,d}$	V_d	$\tau_{v,d}$	Ratio	
	[m]	[N/mm ²]	[-]	[-]	[-]	[N/mm ²]	[kN]	[N/mm ²]		
1	6.0	4.00	1.00	1.00	1.15	4.60	-13.51	0.16	3%	LCO12
2	0.0	4.00	1.00	1.00	1.15	4.60	12.15	0.14	3%	LCO12
3	6.0	4.00	1.00	1.00	1.15	4.60	-11.73	0.14	3%	LCO12
4	6.0	4.00	1.00	1.00	1.15	4.60	-12.15	0.14	3%	LCO12
5	0.0	4.00	1.00	1.00	1.15	4.60	13.51	0.16	3%	LCO12

ULS Fire Rolling shear

Field	Dist.	$f_{r,k}$	γ_m	k_{mod}	k_{ft}	$f_{r,d}$	V_d	$\tau_{r,d}$	Ratio	
	[m]	[N/mm ²]	[-]	[-]	[-]	[N/mm ²]	[kN]	[N/mm ²]		
1	6.0	1.05	1.00	1.00	1.15	1.21	-13.51	0.16	13%	LCO12
2	0.0	1.05	1.00	1.00	1.15	1.21	12.15	0.14	12%	LCO12
3	6.0	1.05	1.00	1.00	1.15	1.21	-11.73	0.14	11%	LCO12
4	6.0	1.05	1.00	1.00	1.15	1.21	-12.15	0.14	12%	LCO12
5	0.0	1.05	1.00	1.00	1.15	1.21	13.51	0.16	13%	LCO12

Stress diagram

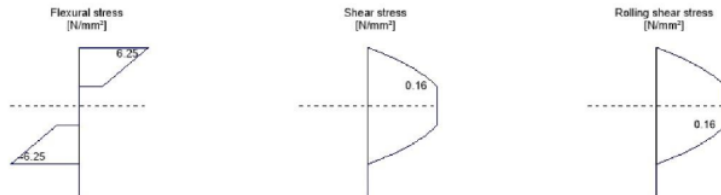



Flexural stress analysis Fire				
$M_{y,d}$	-14.45	kNm	$f_{m,k}$	24.00 N/mm ²
$M_{z,d}$	0.00	kNm	$f_{m,k,z}$	24.00 N/mm ²
$N_{t,d}$	0.00	kN	γ_m	1.00 -
			k_{mod}	1.00 -
			$k_{sys,y}$	1.10 -
			$k_{N,y}$	1.00 -
			$k_{N,z}$	1.00 -
			k_t	1.00 -
			k_{ft}	1.15 -
$\sigma_{t,d}$	0.00	N/mm ²	$f_{t,d}$	16.10 N/mm ²
$\sigma_{m,y,d}$	6.25	N/mm ²	$f_{m,y,d}$	30.36 N/mm ²
$\sigma_{m,z,d}$	0.00	N/mm ² <	$f_{m,z,d}$	0.00 N/mm ² ✓
Utilization ratio				21%
Shear stress analysis Fire				
$V_{y,d}$	-13.51	kN	$f_{v,k}$	4.00 N/mm ²
			γ_m	1.00 -
			k_{mod}	1.00 -
			$k_{N,v}$	0.00 -
			k_{ft}	1.15 -
$\tau_{v,d}$	0.16	N/mm ² <	$f_{v,d}$	4.60 N/mm ² ✓
Utilization ratio				3%
Rolling shear analysis Fire				
$V_{y,d}$	-13.51	kN	$f_{r,k}$	1.05 N/mm ²
			γ_m	1.00 -
			k_{mod}	1.00 -
			k_{ft}	1.15 -
$\tau_{r,d}$	0.16	N/mm ² <	$f_{r,d}$	1.21 N/mm ² ✓
Utilization ratio				13%

© 2024 - Calculatis by Stora Enso - Version 7.10.0
Any use of results of the software is only allowed, if the results have been verified and approved regarding completeness and correctness by a project structural/building physics engineer. For more information see the Terms of Use.



Service limit state design (SLS) - design results

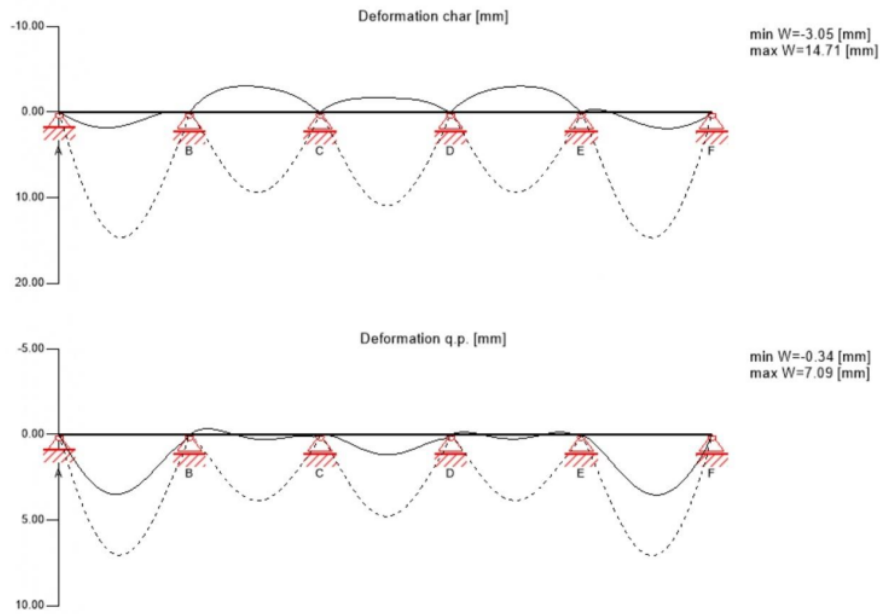

w _{inst} = w(char)					
Field	K _{def}	Limit	w _{inst}	w _{calc.}	Ratio
		[-]	[mm]	[mm]	
1	0.8	L/300	20.0	14.6	73%
2	0.8	L/300	20.0	9.4	47%
3	0.8	L/300	20.0	10.9	55%
4	0.8	L/300	20.0	9.4	47%
5	0.8	L/300	20.0	14.7	74%

© 2024 - Calculatis by Stora Enso - Version 7.10.0
Any use of results of the software is only allowed, if the results have been verified and approved regarding completeness and correctness by a project structural/building physics engineer. For more information see the Terms of Use.



$$w_{lin} = w[char] + w[q.p.] \cdot k_{def}$$

Field	K _{def}	Limit	w _{limit}	w _{calc.}	Ratio
		[-]	[mm]	[mm]	
1	0.8	L/250	24.0	20.3	84%
2	0.8	L/250	24.0	12.5	52%
3	0.8	L/250	24.0	14.8	61%
4	0.8	L/250	24.0	12.5	52%
5	0.8	L/250	24.0	20.4	85%

$$w_{net,lin} = w[q.p.] + w[q.p.] \cdot k_{def}$$

Field	K _{def}	Limit	w _{limit}	w _{calc.}	Ratio
		[-]	[mm]	[mm]	
1	0.8	L/300	20.0	12.7	63%
2	0.8	L/300	20.0	7.0	35%
3	0.8	L/300	20.0	8.6	43%
4	0.8	L/300	20.0	7.0	35%
5	0.8	L/300	20.0	12.8	64%

Vibration analysis

General

Total mass	76.45 [t]
Tributary width	3.9 [m]
Stiffness Longitudinal direction	6336.0 [kNm ²]
Stiffness Cross direction	1664.0 [kNm ²]
Modal damping	4.0 [%]
α	0.1 [-]
Man weight	700.0 [N]
Modal mass	14874.9 [kg]

Analysis

Criterion	Calc.	Class I	Class II	Class I	Class II	Cl. I	Cl. II
Frequency criterion min	6.882 [Hz]	4.5 [Hz]	4.5 [Hz]	65 %	65 %	✓	✓
Frequency criterion	6.882 [Hz]	8.0 [Hz]	6.0 [Hz]	116 %	87 %		
Acceleration criterion	0.015 [m/s ²]	0.05 [m/s ²]	0.1 [m/s ²]	30 %	15 %	✓	✓
Stiffness criterion	0.182 [mm]	0.25 [mm]	0.5 [mm]	73 %	36 %	✓	✓



Support reaction							
Load case category	k_{nod}	A_V	B_V	C_V	D_V	E_V	F_V
[kN]							
self-weight structure	0.6	2.38	6.76	5.86	5.86	6.76	2.38
		2.38	6.76	5.86	5.86	6.76	2.38
dead load	0.6	3.57	10.14	8.79	8.79	10.14	3.57
		3.57	10.14	8.79	8.79	10.14	3.57
live load cat. A: domestic, residential areas	0.8	10.76	28.95	27.72	27.72	28.95	10.76
		-1.24	-1.92	-4.28	-4.28	-1.92	-1.24
snow load altitude < 1.000 m a.s.l.	0.9	2.38	6.76	5.86	5.86	6.76	2.38
		0.00	0.00	0.00	0.00	0.00	0.00
wind load	0.9	0.48	1.35	1.17	1.17	1.35	0.48
		0.00	0.00	0.00	0.00	0.00	0.00

Reference documents for this analysis	
English title	Description
EN 338	EN 338 - Structural timber ? Strength classes
EN 1995-1-1	EN 1995-1-1 - Eurocode 5: Design of timber structures - Part 1-1: General - Common rules and rules for buildings
ETA-14/0349	European Technical Assessment ETA-14/0349
Expertise Rolling shear - no edge gluing, H.J. Blass	Expertise on Rolling shear for CLT
EN 1995-1-2	EN 1995-1-2 - Eurocode 5 — Design of timber structures — Part 1-2: General — Structural fire design
Technical expertise 122/2011/02: analysis of load bearing capacity and separation performance of CLT elements	Verification of the load bearing capacity and the insulation criterion of CLT structures with Stora Enso CLT
Technical expertise 2434/2012 - BB: failure time t_f of gypsum fire boards (GKF) according to ON B 3410	Expertise on failure time t_f of gypsum wall fire boards according to ON B3410 and gypsum wall boards type DF according to EN 520
EN 1990	EN 1990 - Eurocode ? Basis of structural design
ÖNorm B 1995-1-1 NA	ÖNORM EN 1995-1-1 - Austria - National Annex – Nationally determined parameters – Eurocode 5: Design of timber structures – Part 1-1: General-Common rules and rules for buildings
ÖNorm B 1995-1-2 NA	ÖNORM EN 1995-1-2 - Austria - National Annex - Eurocode 5: Design of timber structures ? Part 1-2: General ? Structural fire design ? National specifications concerning ÖNORM EN 1995-1-2, national comments and national supplements



Marija Gulam
University of Zagreb,
Faculty of Civil
Engineering

Reference documents for this analysis

English title	Description
Fire safety in timber buildings - technical guideline for Europe	Fire safety in timber buildings - technical guideline for Europe; publishes by SP Technical Research Institute of Sweden
National specifications concerning ÖNORM EN 1995-1-2, national comments and national supplements, chapter 12	ÖNORM EN 1995-1-2 - National specifications concerning ÖNORM EN 1995-1-2, national comments and national supplements, chapter 12
Expertise Rolling shear, H.J. Blass	Expertise on rolling shear strength and rolling shear modulus of CLT panels
ÖNORM EN 1995-1-1_NA, chapter 7.3	ÖNORM EN 1995-1-1 - Austria - National Annex – Nationally determined parameters – Eurocode 5: Design of timber structures – Part 1-1: General-Common rules and rules for buildings; chapter 7.3

Disclaimer

The software was created to assist engineers in their daily business. The software is an engineering software that is dealing with a very complex matter of structural analysis and building physics analysis. Therefore, this software shall only be operated by skilled, experienced engineers, with a deep understanding of structural engineering and building physics related to timber structures. The user of the software is obliged to check all input values, no matter if they were given by the user or given by default by the software and all results for plausibility. The use of the results of the software should not be relied upon as the basis for any decision or action. Any use of results of the software is only allowed, if the results have been verified and approved regarding completeness and correctness by a project structural/building physics engineer. The user has the possibility to make print-outs from the software. Any modification of those are not allowed. Stora Enso Wood Products GmbH does not assume any warranty regarding the software. The software has been developed with utmost diligence, nevertheless Stora Enso Wood Products GmbH, neither expressly nor implicitly, provides any warranty in terms of accuracy, validity, timeliness and completeness of information and data created by the software. Stora Enso Wood Products GmbH does also not assume any warranty for the general usability of the software, its suitability for a special purpose or for the compatibility of the software with the ones of third party producers or providers. Stora Enso Wood Products GmbH is only liable for damages caused by gross negligence or intent through Stora Enso Wood Products GmbH; the liability for slight negligence is excluded. This does not apply to personal injury. Under the aforementioned conditions Stora Enso Wood Products GmbH is as well not liable for operational failures or the loss of programs and/or data of the user's data processing system. Applicable Law: These terms of use shall be governed by the laws of Austria excluding however any conflict of laws rules and any laws regarding the Convention of the International Sale of Goods (CISG).

2.5.1.2 Ploča velikog raspona



Marija Gulam
University of Zagreb,
Faculty of Civil
Engineering

1/13

System

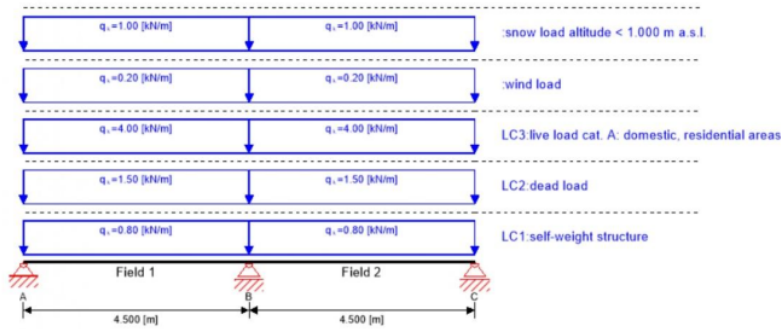

Global utilization ratio

86%

ULS 35% ULS Fire 17% SLS 55% Vibration 86% Support -1%

Product data

Section: CLT 160 L5s

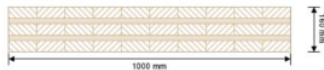

Layer	Thickness	Orientation	Material
1	40.0 mm	0°	C24 spruce ETA (2022)
2	20.0 mm	90°	C24 spruce ETA (2022)
3	40.0 mm	0°	C24 spruce ETA (2022)
4	20.0 mm	90°	C24 spruce ETA (2022)
5	40.0 mm	0°	C24 spruce ETA (2022)
t _{CLT}	160.0 mm		

© 2024 - Calculatis by Stora Enso - Version 7.09.0
Any use of results of the software is only allowed, if the results have been verified and approved regarding completeness and correctness by a project structural/building physics engineer. For more information see the Terms of Use.



Section Fire: CLT 160 L5s

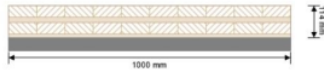

Layer	Thickness	Orientation	Material
1	40.0 mm	0°	C24 spruce ETA (2022)
2	20.0 mm	90°	C24 spruce ETA (2022)
3	40.0 mm	0°	C24 spruce ETA (2022)
4	14.0 mm	90°	C24 spruce ETA (2022)

t_{CLT} **114.0 mm**

Time **60 min**

Fire resistance class: R 60

Fire protection layering:
no additional fire protection

k_0	d_0	$d_{char,0,h}$	$d_{ef,h}$	$d_{char,0,v}$	$d_{ef,v}$
[-]	[mm]	[mm]	[mm]	[mm]	[mm]
1	7	39.0	46.0	0.0	0.0

Material values

Material	$f_{m,k}$	$f_{t,0,k}$	$f_{t,90,k}$	$f_{c,0,k}$	$f_{c,90,k}$	$f_{v,k}$	$f_{r,k \min}$	$E_{0,mean}$	G_{mean}	$G_{r,mean}$
	[N/mm ²]	[N/mm ²]	[N/mm ²]	[N/mm ²]	[N/mm ²]	[N/mm ²]	[N/mm ²]	[N/mm ²]	[N/mm ²]	[N/mm ²]
C24 spruce ETA (2022)	24.00	14.00	0.12	21.00	2.50	4.00	1.25	12,000.00	690.00	50.00

Load

Load case groups

Load case category	Type	Duration	K_{mod}	γ_{ref}	γ_{sup}	ψ_0	ψ_1	ψ_2
LC1 self-weight structure	G	permanent	0.6	1	1.35	1	1	1
LC2 dead load	G	permanent	0.6	1	1.35	1	1	1
LC3 live load cat. A: domestic, residential areas	Q	medium term	0.8	0	1.5	0.7	0.5	0.3
snow load altitude < 1.000 m a.s.l.	Q	short term	0.9	0	1.5	0.5	0.2	0
wind load	Q	short term	0.9	0	1.5	0.6	0.2	0

LC1:self-weight structure



continuous load

Field	Load at start [kN/m]
1	0.80
2	0.80

LC2:dead load

continuous load

Field	Load at start [kN/m]
1	1.50
2	1.50

LC3:live load cat. A: domestic, residential areas

continuous load

Field	Load at start [kN/m]
1	4.00
2	4.00

:snow load altitude < 1.000 m a.s.l.

continuous load

Field	Load at start [kN/m]
1	1.00
2	1.00



:wind load

continuous load

Field	Load at start [kN/m]
1	0.20
2	0.20

ULS Combinations

	Combination rule
LCO1	$1.35/1.00 * LC1 + 1.35/1.00 * LC2$
LCO2	$1.35/1.00 * LC1 + 1.35/1.00 * LC2 + 1.50/0.00 * LC3$
LCO3	$1.35/1.00 * LC1 + 1.35/1.00 * LC2 + 1.50/0.00 * LC3 + 1.50/0.00 * 0.50 *$
LCO4	$1.35/1.00 * LC1 + 1.35/1.00 * LC2 + 1.50/0.00 * LC3 + 1.50/0.00 * 0.50 * + 1.50/0.00 * 0.60 *$
LCO5	$1.35/1.00 * LC1 + 1.35/1.00 * LC2 + 1.50/0.00 *$
LCO6	$1.35/1.00 * LC1 + 1.35/1.00 * LC2 + 1.50/0.00 * + 1.50/0.00 * 0.70 * LC3$
LCO7	$1.35/1.00 * LC1 + 1.35/1.00 * LC2 + 1.50/0.00 * + 1.50/0.00 * 0.70 * LC3 + 1.50/0.00 * 0.60 *$
LCO8	$1.35/1.00 * LC1 + 1.35/1.00 * LC2 + 1.50/0.00 *$
LCO9	$1.35/1.00 * LC1 + 1.35/1.00 * LC2 + 1.50/0.00 * + 1.50/0.00 * 0.70 * LC3$
LCO10	$1.35/1.00 * LC1 + 1.35/1.00 * LC2 + 1.50/0.00 * + 1.50/0.00 * 0.70 * LC3 + 1.50/0.00 * 0.50 *$

ULS Combinations Fire

	Combination rule
LCO11	$1.00/1.00 * LC1 + 1.00/1.00 * LC2$
LCO12	$1.00/1.00 * LC1 + 1.00/1.00 * LC2 + 1.00/0.00 * 0.30 * LC3$
LCO13	$1.00/1.00 * LC1 + 1.00/1.00 * LC2 + 1.00/0.00 * 0.30 * LC3 + 1.00/0.00 * 0.00 *$
LCO14	$1.00/1.00 * LC1 + 1.00/1.00 * LC2 + 1.00/0.00 * 0.30 * LC3 + 1.00/0.00 * 0.00 * + 1.00/0.00 * 0.00 *$
LCO15	$1.00/1.00 * LC1 + 1.00/1.00 * LC2 + 1.00/0.00 * 0.00 *$
LCO16	$1.00/1.00 * LC1 + 1.00/1.00 * LC2 + 1.00/0.00 * 0.00 * + 1.00/0.00 * 0.30 * LC3$
LCO17	$1.00/1.00 * LC1 + 1.00/1.00 * LC2 + 1.00/0.00 * 0.00 * + 1.00/0.00 * 0.30 * LC3 + 1.00/0.00 * 0.00 *$

© 2024 - Calculatis by Stora Enso - Version 7.09.0
Any use of results of the software is only allowed, if the results have been verified and approved regarding completeness and correctness by a project structural/building physics engineer. For more information see the Terms of Use.



ULS Combinations Fire

	Combination rule
LCO18	$1.00/1.00 * LC1 + 1.00/1.00 * LC2 + 1.00/0.00 * 0.00 *$
LCO19	$1.00/1.00 * LC1 + 1.00/1.00 * LC2 + 1.00/0.00 * 0.00 * + 1.00/0.00 * 0.30 * LC3$
LCO20	$1.00/1.00 * LC1 + 1.00/1.00 * LC2 + 1.00/0.00 * 0.00 * + 1.00/0.00 * 0.30 * LC3 + 1.00/0.00 * 0.00 *$

SLS Characteristic Combination

	Combination rule
LCO21	$1.00/1.00 * LC1 + 1.00/1.00 * LC2$
LCO22	$1.00/1.00 * LC1 + 1.00/1.00 * LC2 + 1.00/0.00 * LC3 + 1.00/0.00 * 0.50 * + 1.00/0.00 * 0.60 *$
LCO23	$1.00/1.00 * LC1 + 1.00/1.00 * LC2 + 1.00/0.00 * + 1.00/0.00 * 0.70 * LC3 + 1.00/0.00 * 0.60 *$
LCO24	$1.00/1.00 * LC1 + 1.00/1.00 * LC2 + 1.00/0.00 * + 1.00/0.00 * 0.70 * LC3 + 1.00/0.00 * 0.50 *$

SLS Quasi-permanent Combination

	Combination rule
LCO25	$1.00/1.00 * LC1 + 1.00/1.00 * LC2$
LCO26	$1.00/1.00 * LC1 + 1.00/1.00 * LC2 + 1.00/0.00 * 0.30 * LC3 + 1.00/0.00 * 0.00 * + 1.00/0.00 * 0.00 *$
LCO27	$1.00/1.00 * LC1 + 1.00/1.00 * LC2 + 1.00/0.00 * 0.00 * + 1.00/0.00 * 0.30 * LC3 + 1.00/0.00 * 0.00 *$
LCO28	$1.00/1.00 * LC1 + 1.00/1.00 * LC2 + 1.00/0.00 * 0.00 * + 1.00/0.00 * 0.30 * LC3 + 1.00/0.00 * 0.00 *$

Ultimate limit state (ULS) - design results

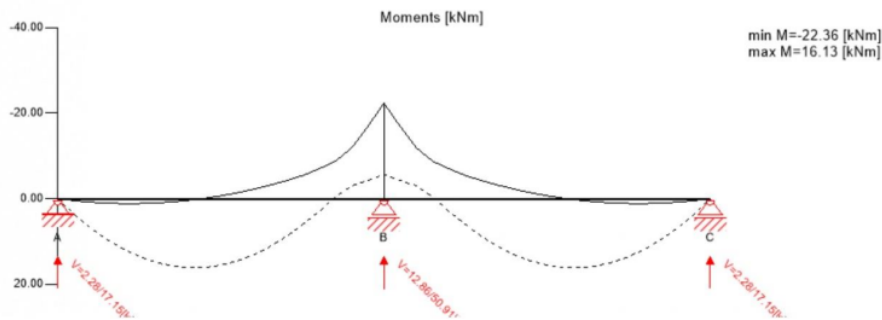

© 2024 - Calculatis by Stora Enso - Version 7.09.0
Any use of results of the software is only allowed, if the results have been verified and approved regarding completeness and correctness by a project structural/building physics engineer. For more information see the Terms of Use.



Ultimate limit state (ULS) - design results

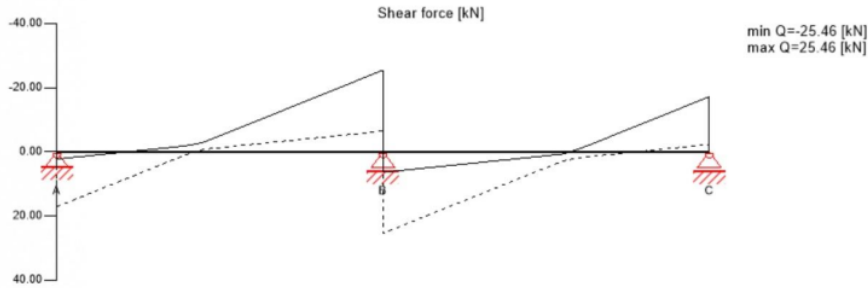

ULS Flexural design

Field	Dist.	$f_{m,k}$	γ_m	k_{mod}	$k_{sys,y}$	$f_{m,y,d}$	$M_{y,d}$	$\sigma_{m,y,d}$	Ratio	
	[m]	[N/mm ²]	[-]	[-]	[-]	[N/mm ²]	[kNm]	[N/mm ²]		
1	4.5	24.00	1.25	0.80	1.10	16.90	-22.36	-5.88	35%	LCO2
2	0.0	24.00	1.25	0.80	1.10	16.90	-22.36	-5.88	35%	LCO2

ULS Shear analysis

Field	Dist.	$f_{v,k}$	γ_m	k_{mod}	$f_{v,d}$	V_d	$\tau_{v,d}$	Ratio	
	[m]	[N/mm ²]	[-]	[-]	[N/mm ²]	[kN]	[N/mm ²]		
1	4.5	4.00	1.25	0.80	2.56	-25.46	0.22	9%	LCO2
2	0.0	4.00	1.25	0.80	2.56	25.46	0.22	9%	LCO2

ULS Rolling shear

Field	Dist.	$f_{r,k}$	γ_m	k_{mod}	$f_{r,d}$	V_d	$\tau_{r,d}$	Ratio	
	[m]	[N/mm ²]	[-]	[-]	[N/mm ²]	[kN]	[N/mm ²]		
1	4.5	1.25	1.25	0.80	0.80	-25.46	0.20	25%	LCO2
2	0.0	1.25	1.25	0.80	0.80	25.46	0.20	25%	LCO2

© 2024 - Calculatis by Stora Enso - Version 7.09.0
Any use of results of the software is only allowed, if the results have been verified and approved regarding completeness and correctness by a project structural/building physics engineer. For more information see the Terms of Use.



Stress diagram

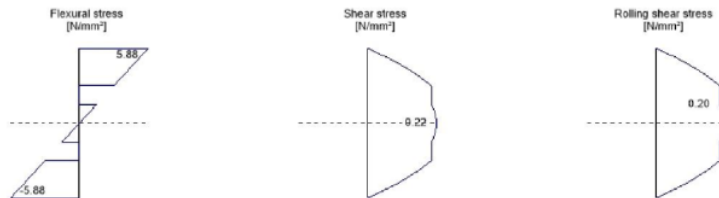

Flexural stress analysis

$M_{y,d}$	=	-22.36	kNm	$f_{m,x}$	=	24.00	N/mm ²
$M_{z,d}$	=	0.00	kNm	$f_{m,x,z}$	=	24.00	N/mm ²
$N_{t,d}$	=	0.00	kN	γ_m	=	1.25	-
				k_{mod}	=	0.80	-
				$k_{sys,y}$	=	1.10	-
				$k_{h,m,y}$	=	1.00	-
				$k_{h,m,z}$	=	1.00	-
				k_i	=	1.00	-
$\sigma_{t,d}$	=	0.00	N/mm ²	$f_{t,0,d}$	=	8.96	N/mm ²
$\sigma_{m,y,d}$	=	-5.88	N/mm ²	$f_{m,y,d}$	=	16.90	N/mm ²
$\sigma_{m,z,d}$	=	0.00	N/mm ²	$f_{m,z,d}$	=	0.00	N/mm ² ✓

Utilization ratio 35%

Shear stress analysis

V_{d}	=	25.46	kN	$f_{v,k}$	=	4.00	N/mm ²
				γ_m	=	1.25	-
				k_{mod}	=	0.80	-
				$k_{h,v}$	=	0.00	-
$\tau_{v,d}$	=	0.22	N/mm ²	$f_{v,d}$	=	2.56	N/mm ² ✓

Utilization ratio 9%

© 2024 - Calculatis by Stora Enso - Version 7.09.0
Any use of results of the software is only allowed, if the results have been verified and approved regarding completeness and correctness by a project structural/building physics engineer. For more information see the Terms of Use.



Rolling shear analysis					
V_{ed}	=	-25.46	kN	$f_{t,k}$	= 1.25 N/mm ²
				γ_m	= 1.25 -
				k_{mod}	= 0.80 -
$T_{r,d}$	=	0.20	N/mm ²	$f_{r,d}$	= 0.80 N/mm ² ✓
Utilization ratio					25%

Ultimate limit state (ULS) fire design - results

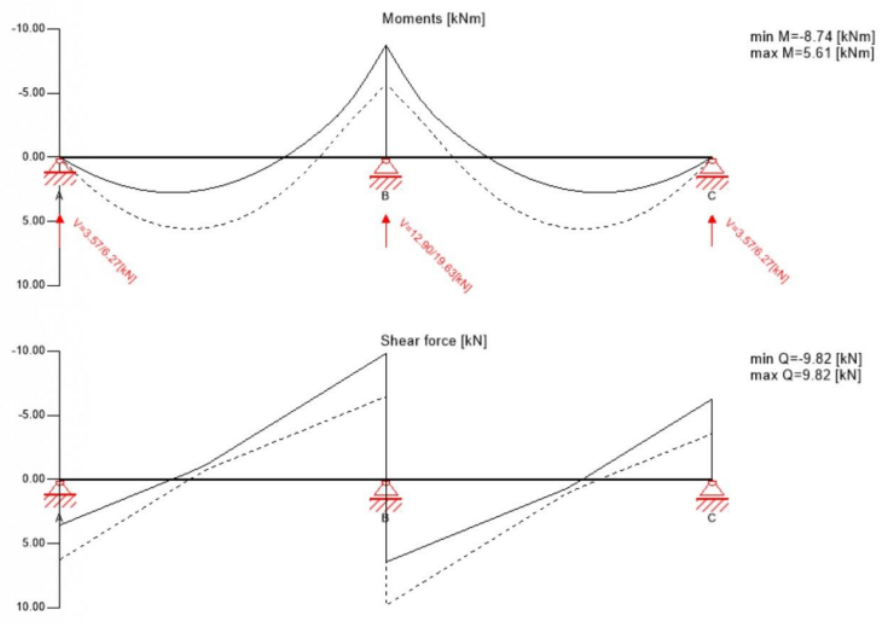

ULS Fire Flexural design											
Field	Dist.	$f_{t,k}$	γ_m	k_{mod}	$k_{sys,y}$	k_s	$f_{m,y,d}$	$M_{y,d}$	$\sigma_{m,y,d}$	Ratio	
	[m]	[N/mm ²]	[-]	[-]	[-]	[-]	[N/mm ²]	[kNm]	[N/mm ²]		
1	4.5	24.00	1.00	1.00	1.10	1.15	30.36	-8.74	-5.28	17%	LCO12
2	0.0	24.00	1.00	1.00	1.10	1.15	30.36	-8.74	-5.28	17%	LCO12

© 2024 - Calculatis by Stora Enso - Version 7.09.0
Any use of results of the software is only allowed, if the results have been verified and approved regarding completeness and correctness by a project structural/building physics engineer. For more information see the Terms of Use.



ULS Fire Shear analysis										
Field	Dist.	$f_{v,k}$	γ_m	k_{mod}	k_n	$f_{v,d}$	V_d	$T_{v,d}$	Ratio	
	[m]	[N/mm ²]	[-]	[-]	[-]	[N/mm ²]	[kN]	[N/mm ²]		
1	4.5	4.00	1.00	1.00	1.15	4.60	-9.82	0.14	3%	LCO12
2	0.0	4.00	1.00	1.00	1.15	4.60	9.82	0.14	3%	LCO12

ULS Fire Rolling shear										
Field	Dist.	$f_{r,k}$	γ_m	k_{mod}	k_n	$f_{r,d}$	V_d	$T_{r,d}$	Ratio	
	[m]	[N/mm ²]	[-]	[-]	[-]	[N/mm ²]	[kN]	[N/mm ²]		
1	4.5	1.25	1.00	1.00	1.15	1.44	-9.82	0.14	10%	LCO12
2	0.0	1.25	1.00	1.00	1.15	1.44	9.82	0.14	10%	LCO12

Stress diagram

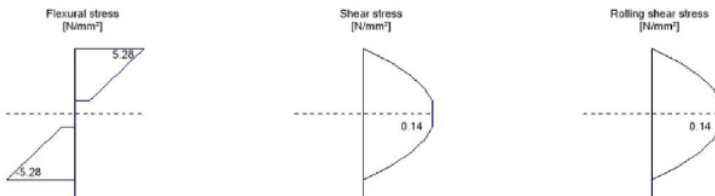

© 2024 - Calculatis by Stora Enso - Version 7.09.0
Any use of results of the software is only allowed, if the results have been verified and approved regarding completeness and correctness by a project structural/building physics engineer. For more information see the Terms of Use.



Flexural stress analysis Fire					
$M_{y,d}$	=	-8.74	kNm	$f_{m,k}$	= 24.00 N/mm ²
$M_{z,d}$	=	0.00	kNm	$f_{m,k,z}$	= 24.00 N/mm ²
$N_{t,d}$	=	0.00	kN	γ_m	= 1.00 -
				K_{mod}	= 1.00 -
				$K_{sys,y}$	= 1.10 -
				$k_{h,m,y}$	= 1.00 -
				$k_{h,m,z}$	= 1.00 -
				k_0	= 1.00 -
				k_0	= 1.15 -
$\sigma_{t,d}$	=	0.00	N/mm ²	$f_{t,0,d}$	= 16.10 N/mm ²
$\sigma_{m,y,d}$	=	-5.28	N/mm ²	$f_{m,y,d}$	= 30.36 N/mm ²
$\sigma_{m,z,d}$	=	0.00	N/mm ² <	$f_{m,z,d}$	= 0.00 N/mm ² ✓
Utilization ratio					17%
Shear stress analysis Fire					
V_{d}	=	-9.82	kN	$f_{v,k}$	= 4.00 N/mm ²
				γ_m	= 1.00 -
				K_{mod}	= 1.00 -
				$k_{h,v}$	= 0.00 -
				k_0	= 1.15 -
$\tau_{v,d}$	=	0.14	N/mm ² <	$f_{v,d}$	= 4.60 N/mm ² ✓
Utilization ratio					3%
Rolling shear analysis Fire					
V_{d}	=	-9.82	kN	$f_{r,k}$	= 1.25 N/mm ²
				γ_m	= 1.00 -
				K_{mod}	= 1.00 -
				k_0	= 1.15 -
$\tau_{r,d}$	=	0.14	N/mm ² <	$f_{r,d}$	= 1.44 N/mm ² ✓
Utilization ratio					10%

© 2024 - Calculatis by Stora Enso - Version 7.09.0
Any use of results of the software is only allowed, if the results have been verified and approved regarding completeness and correctness by a project structural/building physics engineer. For more information see the Terms of Use.



Service limit state design (SLS) - design results

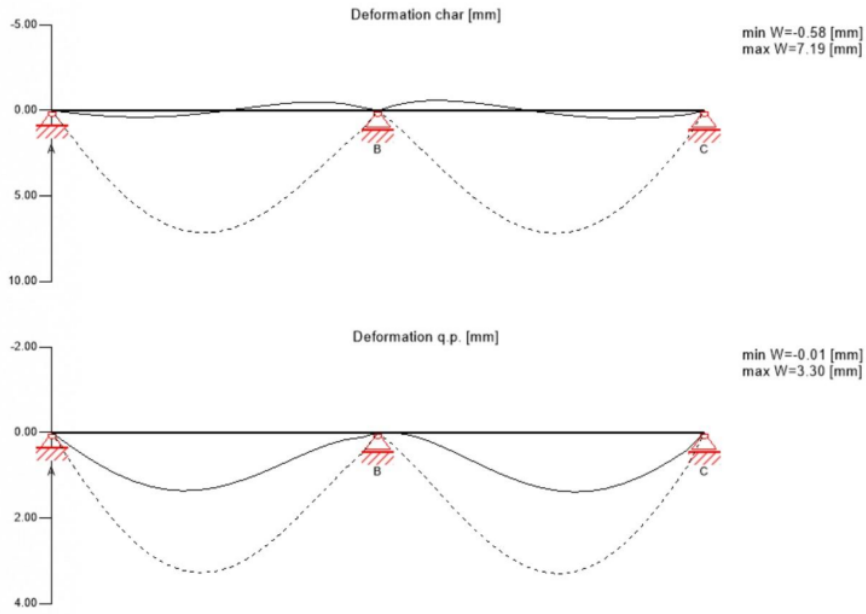

w_{lim} = w[char]

Field	K _{def}	Limit [-]	w _{lim} [mm]	w _{calc.} [mm]	Ratio
1	0.8	L/300	15.0	7.2	48%
2	0.8	L/300	15.0	7.2	48%

w_{lim} = w[char] + w[q.p.]*k_{def}

Field	K _{def}	Limit [-]	w _{lim} [mm]	w _{calc.} [mm]	Ratio
1	0.8	L/250	18.0	9.8	54%
2	0.8	L/250	18.0	9.8	55%

© 2024 - Calculatis by Stora Enso - Version 7.09.0
Any use of results of the software is only allowed, if the results have been verified and approved regarding completeness and correctness by a project structural/building physics engineer. For more information see the Terms of Use.



$w_{nat,fin} = w[q.p.] + w[q.p.]*k_{def}$

Field	K_{def}	Limit	w_{lim}	$w_{calc.}$	Ratio
		[-]	[mm]	[mm]	
1	0.8	L/300	15.0	5.9	39%
2	0.8	L/300	15.0	5.9	40%

Vibration analysis

General

Total mass	10.55	[t]
Tributary width	2.4	[m]
Stiffness Longitudinal direction	3648.0	[kNm ²]
Stiffness Cross direction	448.0	[kNm ²]
Modal damping	1.0	[%]
α	0.0	[-]
Man weight	700.0	[N]
Modal mass	2550.8	[kg]

Analysis

Criterion	Calc.	Class I	Class II	Class I	Class II	Cl. I	Cl. II
Frequency criterion min	9.678 [Hz]	4.5 [Hz]	4.5 [Hz]	46 %	46 %	✓	✓
Frequency criterion	9.678 [Hz]	8.0 [Hz]	6.0 [Hz]	83 %	62 %		
Acceleration criterion	0.114 [m/s ²]	0.05 [m/s ²]	0.1 [m/s ²]	229 %	114 %		
Stiffness criterion	0.215 [mm]	0.25 [mm]	0.5 [mm]	86 %	43 %	✓	✓

Support reaction

Load case category	k_{mod}	A_v	B_v	C_v
				[kN]
self-weight structure	0.6	1.36	4.47	1.36
		1.36	4.47	1.36
dead load	0.6	2.56	8.39	2.56
		2.56	8.39	2.56
live load cat. A: domestic, residential areas	0.8	7.91	22.37	7.91
		-1.09	0.00	-1.09
snow load altitude < 1,000 m a.s.l.	0.9	1.70	5.59	1.70
		0.00	0.00	0.00
wind load	0.9	0.34	1.12	0.34
		0.00	0.00	0.00



Reference documents for this analysis

English title	Description
EN 338	EN 338 - Structural timber ? Strength classes
EN 1995-1-1	EN 1995-1-1 - Eurocode 5: Design of timber structures - Part 1-1: General - Common rules and rules for buildings
ETA-14/0349	European Technical Assessment ETA-14/0349
Expertise Rolling shear - no edge gluing, H.J. Blass	Expertise on Rolling shear for CLT
EN 1995-1-2	EN 1995-1-2 - Eurocode 5 — Design of timber structures — Part 1-2: General — Structural fire design
Technical expertise 122/2011/02: analysis of load bearing capacity and separation performance of CLT elements	Verification of the load bearing capacity and the insulation criterion of CLT structures with Stora Enso CLT
Technical expertise 2434/2012 - BB: failure time t_f of gypsum fire boards (GKF) according to ON B 3410	Expertise on failure time t_f of gypsum wall fire boards according to ON B3410 and gypsum wall boards type DF according to EN 520
EN 1990	EN 1990 - Eurocode ? Basis of structural design
ÖNorm B 1995-1-1 NA	ÖNORM EN 1995-1-1 - Austria - National Annex – Nationally determined parameters – Eurocode 5: Design of timber structures – Part 1-1: General-Common rules and rules for buildings
ÖNorm B 1995-1-2 NA	ÖNORM EN 1995-1-2 - Austria - National Annex - Eurocode 5: Design of timber structures ? Part 1-2: General ? Structural fire design ? National specifications concerning ÖNORM EN 1995-1-2, national comments and national supplements
Fire safety in timber buildings - technical guideline for Europe	Fire safety in timber buildings - technical guideline for Europe; publishes by SP Technical Research Institute of Sweden
National specifications concerning ÖNORM EN 1995-1-2, national comments and national supplements, chapter 12	ÖNORM EN 1995-1-2 - National specifications concerning ÖNORM EN 1995-1-2, national comments and national supplements, chapter 12
Expertise Rolling shear, H.J. Blass	Expertise on rolling shear strength and rolling shear modulus of CLT panels
ÖNORM EN 1995-1-1_NA, chapter 7.3	ÖNORM EN 1995-1-1 - Austria - National Annex – Nationally determined parameters – Eurocode 5: Design of timber structures – Part 1-1: General-Common rules and rules for buildings; chapter 7.3

Disclaimer

The software was created to assist engineers in their daily business. The software is an engineering software that is dealing with a very complex matter of structural analysis and building physics analysis. Therefore, this software shall only be operated by skilled, experienced engineers, with a deep understanding of structural engineering and building physics related to timber structures. The user of the software is obliged to check all input values, no matter if they were given by the user or given by default by the software and all results for plausibility. The use of the results of the software should not be relied upon as the basis for any decision or action. Any use of results of the software is only allowed, if the results have been verified and approved regarding completeness and correctness by a project structural/building physics engineer. The user has the possibility to make print-outs from the software. Any modification of those are not allowed. Stora Enso Wood Products GmbH does not assume any warranty regarding the software. The software has been developed with utmost diligence, nevertheless Stora Enso Wood Products GmbH, neither expressly nor implicitly, provides any warranty in terms of accuracy, validity, timeliness and completeness of information and data created by the software. Stora Enso Wood Products GmbH does also not assume any warranty for the general usability of the software, its suitability for a special purpose or for the compatibility of the software with the ones of third party producers or providers. Stora Enso Wood Products GmbH is only liable for damages caused by gross negligence or intent through Stora Enso Wood Products GmbH; the liability for slight negligence is excluded. This does not apply to personal injury. Under the aforementioned conditions Stora Enso Wood Products GmbH is as well not liable for operational failures or the loss of programs and/or data of the user's data processing system. Applicable Law: These terms of use shall be governed by the laws of Austria excluding however any conflict of laws rules and any laws regarding the Convention of the International Sale of Goods (CISG).

© 2024 - Calculatis by Stora Enso - Version 7.09.0

Any use of results of the software is only allowed, if the results have been verified and approved regarding completeness and correctness by a project structural/building physics engineer. For more information see the Terms of Use.

2.5.2 Međukatna konstrukcija

2.5.2.1 Kontinuirano oslonjena ploča



Marija Gulam
University of Zagreb,
Faculty of Civil
Engineering

1/12

System

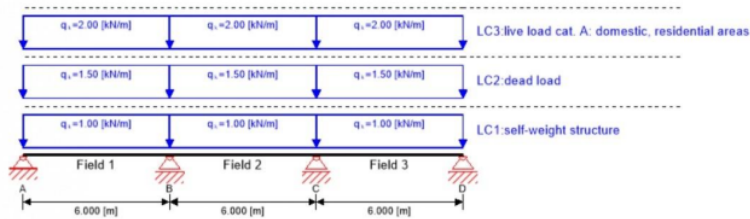

Global utilization ratio

73%

ULS 27% ULS Fire 16% SLS 58% Vibration 73% Support -1%

Product data

Section: CLT 200 L5s

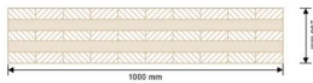

Layer	Thickness	Orientation	Material
1	40.0 mm	0°	C24 spruce ETA (2022)
2	40.0 mm	90°	C24 spruce ETA (2022)
3	40.0 mm	0°	C24 spruce ETA (2022)
4	40.0 mm	90°	C24 spruce ETA (2022)
5	40.0 mm	0°	C24 spruce ETA (2022)
t_{CLT}	200.0 mm		

Section Fire: CLT 200 L5s

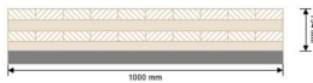

Layer	Thickness	Orientation	Material
1	40.0 mm	0°	C24 spruce ETA (2022)
2	40.0 mm	90°	C24 spruce ETA (2022)
3	40.0 mm	0°	C24 spruce ETA (2022)
4	34.0 mm	90°	C24 spruce ETA (2022)
t_{CLT}	154.0 mm		
Fire resistance class: R 60	Time	60 min	



Section Fire: CLT 200 L5s

Fire protection layering:
no additional fire protection

k_0	d_0	$d_{char,0,h}$	$d_{ef,h}$	$d_{char,0,v}$	$d_{ef,v}$
[-]	[mm]	[mm]	[mm]	[mm]	[mm]
1	7	39.0	46.0	0.0	0.0

Material values

Material	$f_{m,k}$	$f_{t,0,k}$	$f_{t,90,k}$	$f_{c,0,k}$	$f_{c,90,k}$	$f_{v,k}$	$f_{t,k \text{ min}}$	$E_{0,mean}$	G_{mean}	$G_{r,mean}$
	[N/mm ²]	[N/mm ²]	[N/mm ²]	[N/mm ²]	[N/mm ²]	[N/mm ²]	[N/mm ²]	[N/mm ²]	[N/mm ²]	[N/mm ²]
C24 spruce ETA (2022)	24.00	14.00	0.12	21.00	2.50	4.00	1.25	12,000.00	690.00	50.00

Load

Load case groups

Load case category	Type	Duration	K_{mod}	γ_{ref}	γ_{sup}	ψ_0	ψ_1	ψ_2
LC1 self-weight structure	G	permanent	0.6	1	1.35	1	1	1
LC2 dead load	G	permanent	0.6	1	1.35	1	1	1
LC3 live load cat. A: domestic, residential areas	Q	medium term	0.8	0	1.5	0.7	0.5	0.3

LC1:self-weight structure

continuous load

Field	Load at start [kN/m]
1	1.00
2	1.00
3	1.00

LC2:dead load



continuous load	
Field	Load at start [kN/m]
1	1.50
2	1.50
3	1.50

LC3:live load cat. A: domestic, residential areas

continuous load	
Field	Load at start [kN/m]
1	2.00
2	2.00
3	2.00

ULS Combinations

Combination rule	
LCO1	$1.35/1.00 * LC1 + 1.35/1.00 * LC2$
LCO2	$1.35/1.00 * LC1 + 1.35/1.00 * LC2 + 1.50/0.00 * LC3$

ULS Combinations Fire

Combination rule	
LCO3	$1.00/1.00 * LC1 + 1.00/1.00 * LC2$
LCO4	$1.00/1.00 * LC1 + 1.00/1.00 * LC2 + 1.00/0.00 * 0.30 * LC3$

SLS Characteristic Combination

Combination rule	
LCO5	$1.00/1.00 * LC1 + 1.00/1.00 * LC2$
LCO6	$1.00/1.00 * LC1 + 1.00/1.00 * LC2 + 1.00/0.00 * LC3$



SLS Quasi-permanent Combination

Combination rule

LC07 $1.00/1.00 * LC1 + 1.00/1.00 * LC2$

LC08 $1.00/1.00 * LC1 + 1.00/1.00 * LC2 + 1.00/0.00 * 0.30 * LC3$

Ultimate limit state (ULS) - design results

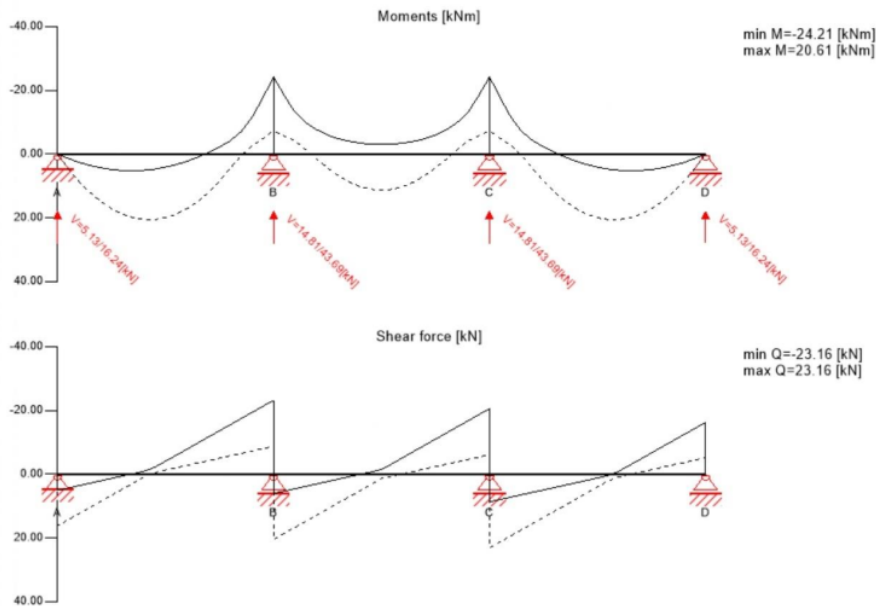

ULS Flexural design

Field	Dist. [m]	$f_{m,k}$ [N/mm ²]	γ_m [-]	k_{nod} [-]	$k_{sys,y}$ [-]	$f_{m,y,d}$ [N/mm ²]	$M_{y,d}$ [kNm]	$\sigma_{m,y,d}$ [N/mm ²]	Ratio	
1	6.0	24.00	1.25	0.80	1.10	16.90	-24.21	4.58	27%	LCO2
2	0.0	24.00	1.25	0.80	1.10	16.90	-24.21	4.58	27%	LCO2
3	0.0	24.00	1.25	0.80	1.10	16.90	-24.21	4.58	27%	LCO2

© 2024 - Calculati by Stora Enso - Version 7.10.0
Any use of results of the software is only allowed, if the results have been verified and approved regarding completeness and correctness by a project structural/building physics engineer. For more information see the Terms of Use.



ULS Shear analysis

Field	Dist.	$f_{v,k}$	γ_m	k_{nod}	$f_{v,d}$	V_d	$T_{v,d}$	Ratio	
	[m]	[N/mm ²]	[-]	[-]	[N/mm ²]	[kN]	[N/mm ²]		
1	6.0	4.00	1.25	0.80	2.56	-23.16	0.15	6%	LCO2
2	6.0	4.00	1.25	0.80	2.56	-20.53	0.13	5%	LCO2
3	0.0	4.00	1.25	0.80	2.56	23.16	0.15	6%	LCO2

ULS Rolling shear

Field	Dist.	$f_{r,k}$	γ_m	k_{nod}	$f_{r,d}$	V_d	$T_{r,d}$	Ratio	
	[m]	[N/mm ²]	[-]	[-]	[N/mm ²]	[kN]	[N/mm ²]		
1	6.0	1.05	1.25	0.80	0.67	-23.16	0.14	21%	LCO2
2	6.0	1.05	1.25	0.80	0.67	-20.53	0.12	19%	LCO2
3	0.0	1.05	1.25	0.80	0.67	23.16	0.14	21%	LCO2

Stress diagram

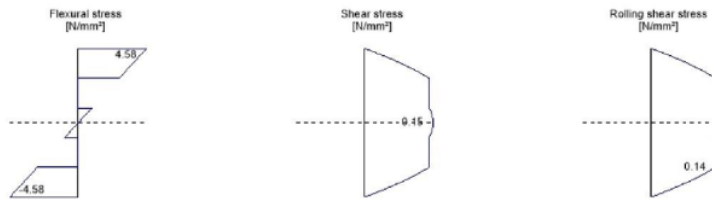



Flexural stress analysis				
$M_{y,d}$	-24.21	kNm	$f_{m,k}$	24.00 N/mm ²
$M_{z,d}$	0.00	kNm	$f_{m,k,z}$	24.00 N/mm ²
$N_{t,d}$	0.00	kN	γ_m	1.25 -
			K_{mod}	0.80 -
			$K_{sys,y}$	1.10 -
			$K_{s,m,y}$	1.00 -
			$K_{s,m,z}$	1.00 -
			k_t	1.00 -
$\sigma_{t,d}$	0.00	N/mm ²	$f_{t,0,d}$	8.96 N/mm ²
$\sigma_{m,y,d}$	4.58	N/mm ²	$f_{m,y,d}$	16.90 N/mm ²
$\sigma_{m,z,d}$	0.00	N/mm ² <	$f_{m,z,d}$	0.00 N/mm ² ✓
Utilization ratio				27%
Shear stress analysis				
V_{d}	-23.16	kN	$f_{v,k}$	4.00 N/mm ²
			γ_m	1.25 -
			K_{mod}	0.80 -
			$K_{h,v}$	0.00 -
$\tau_{v,d}$	0.15	N/mm ² <	$f_{v,d}$	2.56 N/mm ² ✓
Utilization ratio				6%
Rolling shear analysis				
V_{d}	-23.16	kN	$f_{r,k}$	1.05 N/mm ²
			γ_m	1.25 -
			K_{mod}	0.80 -
$\tau_{r,d}$	0.14	N/mm ² <	$f_{r,d}$	0.67 N/mm ² ✓
Utilization ratio				21%



Ultimate limit state (ULS) fire design - results

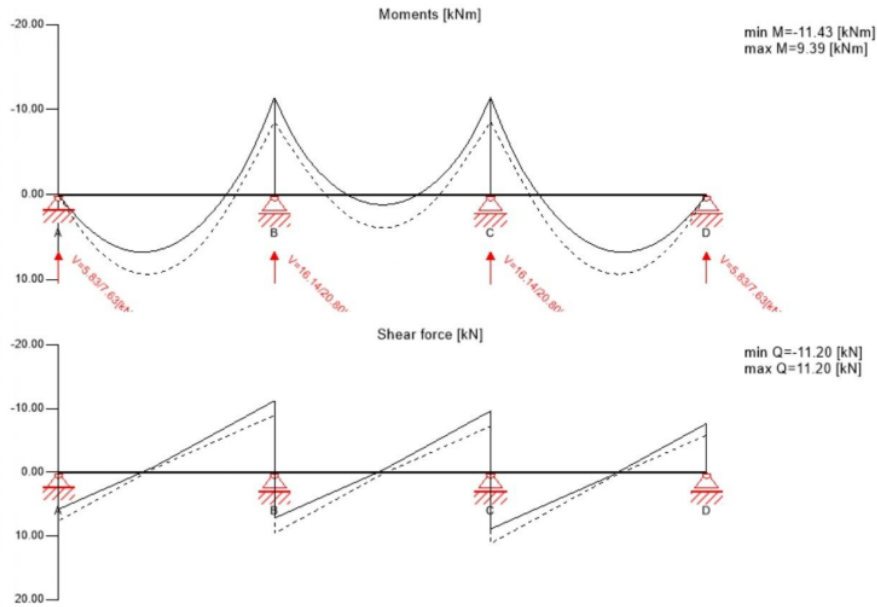

ULS Fire Flexural design

Field	Dist.	$f_{m,k}$	γ_m	k_{mod}	$k_{sys,y}$	k_s	$f_{m,y,d}$	$M_{y,d}$	$\sigma_{m,y,d}$	Ratio	
	[m]	[N/mm ²]	[-]	[-]	[-]	[-]	[N/mm ²]	[kNm]	[N/mm ²]		
1	6.0	24.00	1.00	1.00	1.10	1.15	30.36	-11.43	4.94	16%	LCO4
2	0.0	24.00	1.00	1.00	1.10	1.15	30.36	-11.43	4.94	16%	LCO4
3	0.0	24.00	1.00	1.00	1.10	1.15	30.36	-11.43	4.94	16%	LCO4

ULS Fire Shear analysis

Field	Dist.	$f_{v,k}$	γ_m	k_{mod}	k_s	$f_{v,d}$	V_d	$\tau_{v,d}$	Ratio	
	[m]	[N/mm ²]	[-]	[-]	[-]	[N/mm ²]	[kN]	[N/mm ²]		
1	6.0	4.00	1.00	1.00	1.15	4.60	-11.20	0.13	3%	LCO4
2	6.0	4.00	1.00	1.00	1.15	4.60	-9.59	0.11	2%	LCO4

© 2024 - Calculatis by Stora Enso - Version 7.10.0
Any use of results of the software is only allowed, if the results have been verified and approved regarding completeness and correctness by a project structural/building physics engineer. For more information see the Terms of Use.



ULS Fire Shear analysis

Field	Dist.	$f_{v,k}$	γ_m	k_{mod}	k_s	$f_{v,d}$	V_d	$\tau_{v,d}$	Ratio	
	[m]	[N/mm ²]	[-]	[-]	[-]	[N/mm ²]	[kN]	[N/mm ²]		
3	0.0	4.00	1.00	1.00	1.15	4.60	11.20	0.13	3%	LCO4

ULS Fire Rolling shear

Field	Dist.	$f_{r,k}$	γ_m	k_{mod}	k_s	$f_{r,d}$	V_d	$\tau_{r,d}$	Ratio	
	[m]	[N/mm ²]	[-]	[-]	[-]	[N/mm ²]	[kN]	[N/mm ²]		
1	6.0	1.05	1.00	1.00	1.15	1.21	-11.20	0.13	11%	LCO4
2	6.0	1.05	1.00	1.00	1.15	1.21	-9.59	0.11	9%	LCO4
3	0.0	1.05	1.00	1.00	1.15	1.21	11.20	0.13	11%	LCO4

Stress diagram

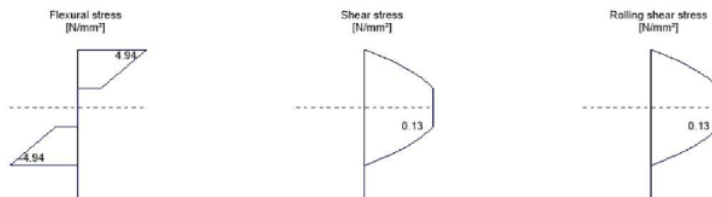



Flexural stress analysis Fire				
$M_{y,d}$	-11.43	kNm	$f_{m,k}$	24.00 N/mm ²
$M_{z,d}$	0.00	kNm	$f_{m,k,z}$	24.00 N/mm ²
N_{d}	0.00	kN	γ_m	1.00 -
			k_{mod}	1.00 -
			$k_{sys,y}$	1.10 -
			$k_{s,m,y}$	1.00 -
			$k_{s,m,z}$	1.00 -
			k_t	1.00 -
			k_a	1.15 -
$\sigma_{t,d}$	0.00	N/mm ²	$f_{t,d}$	16.10 N/mm ²
$\sigma_{m,y,d}$	4.94	N/mm ²	$f_{m,y,d}$	30.36 N/mm ²
$\sigma_{m,z,d}$	0.00	N/mm ² <	$f_{m,z,d}$	0.00 N/mm ² ✓
Utilization ratio				16%
Shear stress analysis Fire				
V_{d}	-11.20	kN	$f_{v,k}$	4.00 N/mm ²
			γ_m	1.00 -
			k_{mod}	1.00 -
			$k_{s,v}$	0.00 -
			k_a	1.15 -
$\tau_{v,d}$	0.13	N/mm ² <	$f_{v,d}$	4.60 N/mm ² ✓
Utilization ratio				3%
Rolling shear analysis Fire				
V_{d}	-11.20	kN	$f_{r,k}$	1.05 N/mm ²
			γ_m	1.00 -
			k_{mod}	1.00 -
			k_a	1.15 -
$\tau_{r,d}$	0.13	N/mm ² <	$f_{r,d}$	1.21 N/mm ² ✓
Utilization ratio				11%

© 2024 - Calculatis by Stora Enso - Version 7.10.0
Any use of results of the software is only allowed, if the results have been verified and approved regarding completeness and correctness by a project structural/building physics engineer. For more information see the Terms of Use.



Service limit state design (SLS) - design results

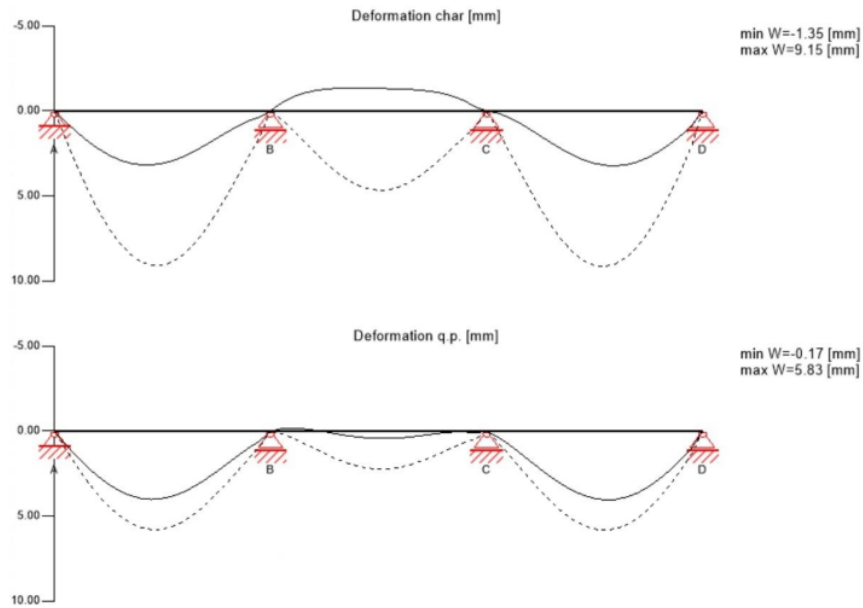

$w_{inst} = w[char]$

Field	K_{def}	Limit	w_{limit}	$w_{calc.}$	Ratio
		[-]	[mm]	[mm]	
1	0.8	L/300	20.0	9.1	45%
2	0.8	L/300	20.0	4.7	23%
3	0.8	L/300	20.0	9.1	46%

$w_{fin} = w[char] + w[q.p.] \cdot k_{def}$

Field	K_{def}	Limit	w_{limit}	$w_{calc.}$	Ratio
		[-]	[mm]	[mm]	
1	0.8	L/250	24.0	13.7	57%
2	0.8	L/250	24.0	6.5	27%

© 2024 - Calculatis by Stora Enso - Version 7.10.0
Any use of results of the software is only allowed, if the results have been verified and approved regarding completeness and correctness by a project structural/building physics engineer. For more information see the Terms of Use.



$w_{fin} = w[char] + w[q.p.] \cdot k_{def}$

Field	K_{def}	Limit	w_{limit}	$w_{calc.}$	Ratio
		[-]	[mm]	[mm]	
3	0.8	L/250	24.0	13.8	58%

$w_{net,fin} = w[q.p.] + w[q.p.] \cdot k_{def}$

Field	K_{def}	Limit	w_{limit}	$w_{calc.}$	Ratio
		[-]	[mm]	[mm]	
1	0.8	L/300	20.0	10.4	52%
2	0.8	L/300	20.0	4.0	20%
3	0.8	L/300	20.0	10.5	52%

Vibration analysis

General

Total mass	45.87 [t]
Tributary width	3.9 [m]
Stiffness Longitudinal direction	6336.0 [kNm ²]
Stiffness Cross direction	1664.0 [kNm ²]
Modal damping	4.0 [%]
α	0.1 [-]
Man weight	700.0 [N]
Modal mass	8935.2 [kg]

Analysis

Criterion	Calc.	Class I	Class II	Class I	Class II	Cl. I	Cl. II
Frequency criterion min	6.882 [Hz]	4.5 [Hz]	4.5 [Hz]	65 %	65 %	✓	✓
Frequency criterion	6.882 [Hz]	8.0 [Hz]	6.0 [Hz]	116 %	87 %		
Acceleration criterion	0.025 [m/s ²]	0.05 [m/s ²]	0.1 [m/s ²]	50 %	25 %	✓	
Stiffness criterion	0.182 [mm]	0.25 [mm]	0.5 [mm]	73 %	36 %	✓	✓

Support reaction

Load case category	k_{mod}	A_v	B_v	C_v	D_v
self-weight structure	0.6	2.41	6.59	6.59	2.41
		2.41	6.59	6.59	2.41
dead load	0.6	3.61	9.89	9.89	3.61
		3.61	9.89	9.89	3.61
live load cat. A: domestic, residential areas	0.8	5.41	14.30	14.30	5.41
		-0.59	-1.11	-1.11	-0.59



Reference documents for this analysis

English title	Description
EN 338	EN 338 - Structural timber ? Strength classes
EN 1995-1-1	EN 1995-1-1 - Eurocode 5: Design of timber structures - Part 1-1: General - Common rules and rules for buildings
ETA-14/0349	European Technical Assessment ETA-14/0349
Expertise Rolling shear - no edge gluing, H.J. Blass	Expertise on Rolling shear for CLT
EN 1995-1-2	EN 1995-1-2 - Eurocode 5 — Design of timber structures — Part 1-2: General — Structural fire design
Technical expertise 122/2011/02: analysis of load bearing capacity and separation performance of CLT elements	Verification of the load bearing capacity and the insulation criterion of CLT structures with Stora Enso CLT
Technical expertise 2434/2012 - BB: failure time t_f of gypsum fire boards (GKF) according to ON B 3410	Expertise on failure time t_f of gypsum wall fire boards according to ON B3410 and gypsum wall boards type DF according to EN 520
EN 1990	EN 1990 - Eurocode ? Basis of structural design
ÖNorm B 1995-1-1 NA	ÖNORM EN 1995-1-1 - Austria - National Annex – Nationally determined parameters – Eurocode 5: Design of timber structures – Part 1-1: General-Common rules and rules for buildings
ÖNorm B 1995-1-2 NA	ÖNORM EN 1995-1-2 - Austria - National Annex - Eurocode 5: Design of timber structures ? Part 1-2: General ? Structural fire design ? National specifications concerning ÖNORM EN 1995-1-2, national comments and national supplements
Fire safety in timber buildings - technical guideline for Europe	Fire safety in timber buildings - technical guideline for Europe; publishes by SP Technical Research Institute of Sweden
National specifications concerning ÖNORM EN 1995-1-2, national comments and national supplements, chapter 12	ÖNORM EN 1995-1-2 - National specifications concerning ÖNORM EN 1995-1-2, national comments and national supplements, chapter 12
Expertise Rolling shear, H.J. Blass	Expertise on rolling shear strength and rolling shear modulus of CLT panels
ÖNORM EN 1995-1-1_NA, chapter 7.3	ÖNORM EN 1995-1-1 - Austria - National Annex – Nationally determined parameters – Eurocode 5: Design of timber structures – Part 1-1: General-Common rules and rules for buildings; chapter 7.3

Disclaimer

The software was created to assist engineers in their daily business. The software is an engineering software that is dealing with a very complex matter of structural analysis and building physics analysis. Therefore, this software shall only be operated by skilled, experienced engineers, with a deep understanding of structural engineering and building physics related to timber structures. The user of the software is obliged to check all input values, no matter if they were given by the user or given by default by the software and all results for plausibility. The use of the results of the software should not be relied upon as the basis for any decision or action. Any use of results of the software is only allowed, if the results have been verified and approved regarding completeness and correctness by a project structural/building physics engineer. The user has the possibility to make print-outs from the software. Any modification of those are not allowed. Stora Enso Wood Products GmbH does not assume any warranty regarding the software. The software has been developed with utmost diligence, nevertheless Stora Enso Wood Products GmbH, neither expressly nor implicitly, provides any warranty in terms of accuracy, validity, timeliness and completeness of information and data created by the software. Stora Enso Wood Products GmbH does also not assume any warranty for the general usability of the software, its suitability for a special purpose or for the compatibility of the software with the ones of third party producers or providers. Stora Enso Wood Products GmbH is only liable for damages caused by gross negligence or intent through Stora Enso Wood Products GmbH; the liability for slight negligence is excluded. This does not apply to personal injury. Under the aforementioned conditions Stora Enso Wood Products GmbH is as well not liable for operational failures or the loss of programs and/or data of the user's data processing system. Applicable Law: These terms of use shall be governed by the laws of Austria excluding however any conflict of laws rules and any laws regarding the Convention of the International Sale of Goods (CISG).

© 2024 - Calculatis by Stora Enso - Version 7.10.0

Any use of results of the software is only allowed, if the results have been verified and approved regarding completeness and correctness by a project structural/building physics engineer. For more information see the Terms of Use.

2.5.2.2 Ploča velikog raspona



Marija Gulam
University of Zagreb,
Faculty of Civil
Engineering

1/12

System

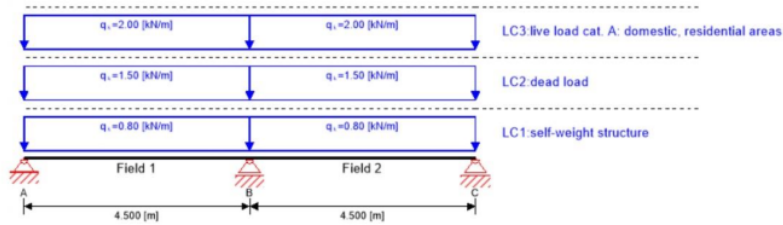

Global utilization ratio

86%

ULS 23% ULS Fire 14% SLS 35% Vibration 86% Support -1%

Product data

Section: CLT 160 L5s

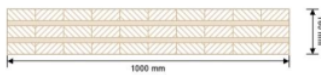

Layer	Thickness	Orientation	Material
1	40.0 mm	0°	C24 spruce ETA (2022)
2	20.0 mm	90°	C24 spruce ETA (2022)
3	40.0 mm	0°	C24 spruce ETA (2022)
4	20.0 mm	90°	C24 spruce ETA (2022)
5	40.0 mm	0°	C24 spruce ETA (2022)
t_{CLT}	160.0 mm		

Section Fire: CLT 160 L5s

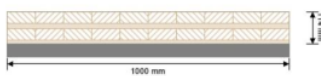

Layer	Thickness	Orientation	Material
1	40.0 mm	0°	C24 spruce ETA (2022)
2	20.0 mm	90°	C24 spruce ETA (2022)
3	40.0 mm	0°	C24 spruce ETA (2022)
4	14.0 mm	90°	C24 spruce ETA (2022)
t_{CLT}	114.0 mm		

Fire resistance class: R 60

Time **60 min**

© 2024 - Calculatis by Stora Enso - Version 7.09.0
Any use of results of the software is only allowed, if the results have been verified and approved regarding completeness and correctness by a project structural/building physics engineer. For more information see the Terms of Use.



Section Fire: CLT 160 L5s

Fire protection layering:
no additional fire protection

k_0	d_0	$d_{char,0,h}$	$d_{ef,h}$	$d_{char,0,v}$	$d_{ef,v}$
[-]	[mm]	[mm]	[mm]	[mm]	[mm]
1	7	39.0	46.0	0.0	0.0

Material values

Material	$f_{m,k}$	$f_{t,0,k}$	$f_{t,90,k}$	$f_{c,0,k}$	$f_{c,90,k}$	$f_{v,k}$	$f_{t,k,min}$	$E_{0,mean}$	G_{mean}	$G_{r,mean}$
	[N/mm ²]	[N/mm ²]	[N/mm ²]	[N/mm ²]	[N/mm ²]	[N/mm ²]	[N/mm ²]	[N/mm ²]	[N/mm ²]	[N/mm ²]
C24 spruce ETA (2022)	24.00	14.00	0.12	21.00	2.50	4.00	1.25	12,000.00	690.00	50.00

Load

Load case groups

Load case category	Type	Duration	K_{mod}	γ_{inf}	γ_{sup}	ψ_0	ψ_1	ψ_2
LC1 self-weight structure	G	permanent	0.6	1	1.35	1	1	1
LC2 dead load	G	permanent	0.6	1	1.35	1	1	1
LC3 live load cat. A: domestic, residential areas	Q	medium term	0.8	0	1.5	0.7	0.5	0.3

LC1:self-weight structure

continuous load

Field	Load at start
	[kN/m]
1	0.80
2	0.80

LC2:dead load

continuous load

Field	Load at start
	[kN/m]
1	1.50

© 2024 - Calculatis by Stora Enso - Version 7.09.0
Any use of results of the software is only allowed, if the results have been verified and approved regarding completeness and correctness by a project structural/building physics engineer. For more information see the Terms of Use.



continuous load	
Field	Load at start
	[kN/m]
2	1.50

LC3:live load cat. A: domestic, residential areas

continuous load	
Field	Load at start
	[kN/m]
1	2.00
2	2.00

ULS Combinations

	Combination rule
LCO1	$1.35/1.00 * LC1 + 1.35/1.00 * LC2$
LCO2	$1.35/1.00 * LC1 + 1.35/1.00 * LC2 + 1.50/0.00 * LC3$

ULS Combinations Fire

	Combination rule
LCO3	$1.00/1.00 * LC1 + 1.00/1.00 * LC2$
LCO4	$1.00/1.00 * LC1 + 1.00/1.00 * LC2 + 1.00/0.00 * 0.30 * LC3$

SLS Characteristic Combination

	Combination rule
LCO5	$1.00/1.00 * LC1 + 1.00/1.00 * LC2$
LCO6	$1.00/1.00 * LC1 + 1.00/1.00 * LC2 + 1.00/0.00 * LC3$

SLS Quasi-permanent Combination

	Combination rule
LCO7	$1.00/1.00 * LC1 + 1.00/1.00 * LC2$
LCO8	$1.00/1.00 * LC1 + 1.00/1.00 * LC2 + 1.00/0.00 * 0.30 * LC3$



Ultimate limit state (ULS) - design results

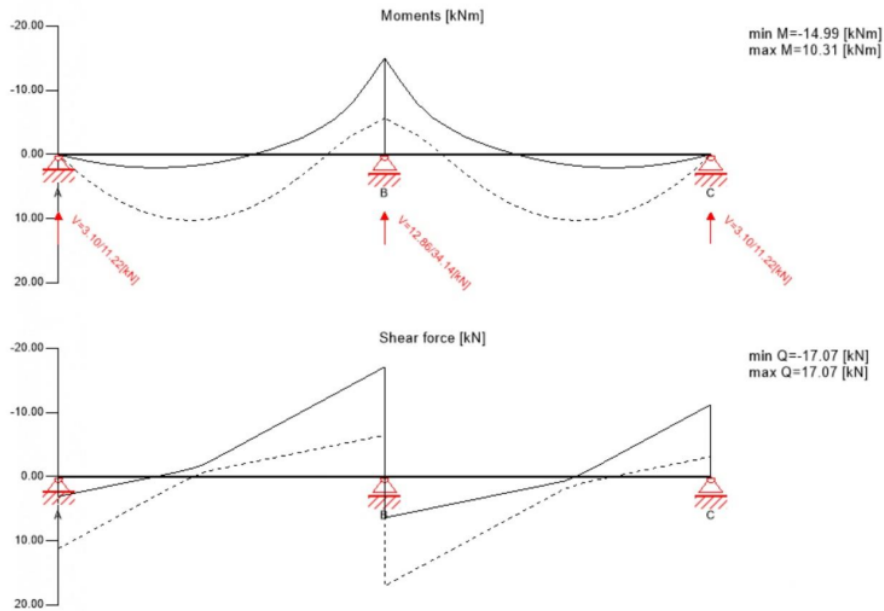

ULS Flexural design

Field	Dist.	$f_{m,k}$	γ_m	k_{mod}	$k_{sys,y}$	$f_{m,y,d}$	$M_{y,d}$	$\sigma_{m,y,d}$	Ratio	
	[m]	[N/mm ²]	[-]	[-]	[-]	[N/mm ²]	[kNm]	[N/mm ²]		
1	4.5	24.00	1.25	0.80	1.10	16.90	-14.99	-3.95	23%	LCO2
2	0.0	24.00	1.25	0.80	1.10	16.90	-14.99	-3.95	23%	LCO2

ULS Shear analysis

Field	Dist.	$f_{v,k}$	γ_m	k_{mod}	$f_{v,d}$	V_d	$\tau_{v,d}$	Ratio	
	[m]	[N/mm ²]	[-]	[-]	[N/mm ²]	[kN]	[N/mm ²]		
1	4.5	4.00	1.25	0.80	2.56	-17.07	0.15	6%	LCO2
2	0.0	4.00	1.25	0.80	2.56	17.07	0.15	6%	LCO2

© 2024 - Calculatis by Stora Enso - Version 7.09.0
Any use of results of the software is only allowed, if the results have been verified and approved regarding completeness and correctness by a project structural/building physics engineer. For more information see the Terms of Use.



ULS Rolling shear

Field	Dist.	$f_{r,k}$	γ_m	k_{mod}	$f_{r,d}$	V_d	$\tau_{r,d}$	Ratio	
	[m]	[N/mm ²]	[-]	[-]	[N/mm ²]	[kN]	[N/mm ²]		
1	4.5	1.25	1.25	0.80	0.80	-17.07	0.13	17%	LCO2
2	0.0	1.25	1.25	0.80	0.80	17.07	0.13	17%	LCO2

Stress diagram

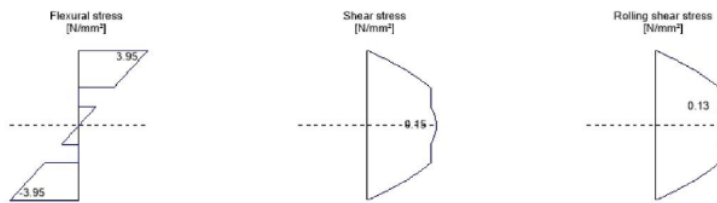

Flexural stress analysis

$M_{y,d} =$	-14.99	kNm	$f_{m,k} =$	24.00	N/mm ²
$M_{z,d} =$	0.00	kNm	$f_{m,k,z} =$	24.00	N/mm ²
$N_{x,d} =$	0.00	kN	$\gamma_m =$	1.25	-
			$k_{mod} =$	0.80	-
			$k_{sys,y} =$	1.10	-
			$k_{n,m,y} =$	1.00	-
			$k_{n,m,z} =$	1.00	-
			$k_t =$	1.00	-
$\sigma_{t,d} =$	0.00	N/mm ²	$f_{t,d} =$	8.96	N/mm ²
$\sigma_{m,y,d} =$	-3.95	N/mm ²	$f_{m,y,d} =$	16.90	N/mm ²
$\sigma_{m,z,d} =$	0.00	N/mm ²	$f_{m,z,d} =$	0.00	N/mm ² ✓

Utilization ratio

23%



Shear stress analysis					
$V_d =$	17.07	kN	$f_{v,k} =$	4.00	N/mm ²
			$\gamma_m =$	1.25	-
			$k_{mod} =$	0.80	-
			$k_{c,v} =$	0.00	-
$\tau_{v,d} =$	0.15	N/mm ²	$f_{v,d} =$	2.56	N/mm ² ✓
Utilization ratio					6%

Rolling shear analysis					
$V_d =$	17.07	kN	$f_{t,k} =$	1.25	N/mm ²
			$\gamma_m =$	1.25	-
			$k_{mod} =$	0.80	-
$\tau_{r,d} =$	0.13	N/mm ²	$f_{r,d} =$	0.80	N/mm ² ✓
Utilization ratio					17%

Ultimate limit state (ULS) fire design - results

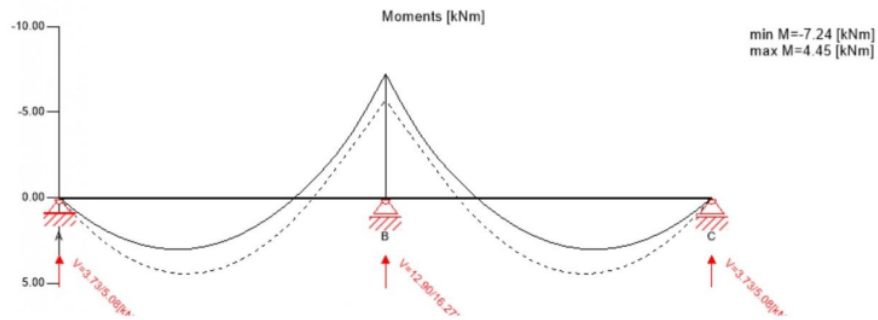

© 2024 - Calculatis by Stora Enso - Version 7.09.0
Any use of results of the software is only allowed, if the results have been verified and approved regarding completeness and correctness by a project structural/building physics engineer. For more information see the Terms of Use.



Ultimate limit state (ULS) fire design - results

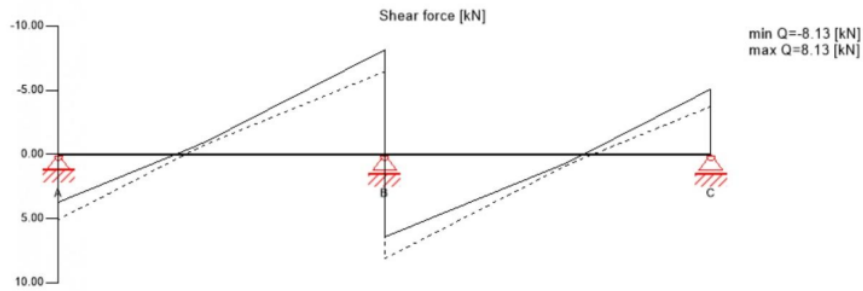

ULS Fire Flexural design

Field	Dist.	$f_{m,k}$	γ_m	k_{rod}	$k_{sys,y}$	k_E	$f_{m,y,d}$	$M_{y,d}$	$\sigma_{m,y,d}$	Ratio	
	[m]	[N/mm ²]	[-]	[-]	[-]	[-]	[N/mm ²]	[kNm]	[N/mm ²]		
1	4.5	24.00	1.00	1.00	1.10	1.15	30.36	-7.24	-4.38	14%	LCO4
2	0.0	24.00	1.00	1.00	1.10	1.15	30.36	-7.24	-4.38	14%	LCO4

ULS Fire Shear analysis

Field	Dist.	$f_{v,k}$	γ_m	k_{rod}	k_E	$f_{v,d}$	V_d	$\tau_{v,d}$	Ratio	
	[m]	[N/mm ²]	[-]	[-]	[-]	[N/mm ²]	[kN]	[N/mm ²]		
1	4.5	4.00	1.00	1.00	1.15	4.60	-8.13	0.12	3%	LCO4
2	0.0	4.00	1.00	1.00	1.15	4.60	8.13	0.12	3%	LCO4

ULS Fire Rolling shear

Field	Dist.	$f_{r,k}$	γ_m	k_{rod}	k_E	$f_{r,d}$	V_d	$\tau_{r,d}$	Ratio	
	[m]	[N/mm ²]	[-]	[-]	[-]	[N/mm ²]	[kN]	[N/mm ²]		
1	4.5	1.25	1.00	1.00	1.15	1.44	-8.13	0.12	8%	LCO4
2	0.0	1.25	1.00	1.00	1.15	1.44	8.13	0.12	8%	LCO4

© 2024 - Calculatis by Stora Enso - Version 7.09.0
Any use of results of the software is only allowed, if the results have been verified and approved regarding completeness and correctness by a project structural/building physics engineer. For more information see the Terms of Use.



Stress diagram

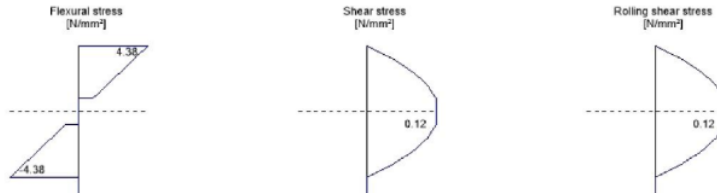

Flexural stress analysis Fire

$M_{y,d}$	=	-7.24	kNm	$f_{m,k}$	=	24.00	N/mm ²
$M_{z,d}$	=	0.00	kNm	$f_{m,k,z}$	=	24.00	N/mm ²
N_{d}	=	0.00	kN	γ_m	=	1.00	-
				k_{mod}	=	1.00	-
				$k_{sys,y}$	=	1.10	-
				$k_{t,m,y}$	=	1.00	-
				$k_{t,m,z}$	=	1.00	-
				k_t	=	1.00	-
				k_B	=	1.15	-
$\sigma_{t,d}$	=	0.00	N/mm ²	$f_{t,d}$	=	16.10	N/mm ²
$\sigma_{m,y,d}$	=	-4.38	N/mm ²	$f_{m,y,d}$	=	30.36	N/mm ²
$\sigma_{m,z,d}$	=	0.00	N/mm ²	$f_{m,z,d}$	=	0.00	N/mm ² ✓

Utilization ratio 14%



Shear stress analysis Fire				
V_{d}	=	-8.13	kN	
				$f_{v,k}$ = 4.00 N/mm ²
				γ_m = 1.00 -
				k_{mod} = 1.00 -
				$k_{c,v}$ = 0.00 -
				k_{β} = 1.15 -
$T_{v,d}$	=	0.12	N/mm ² <	$f_{v,d}$ = 4.60 N/mm ² ✓
Utilization ratio				3%

Rolling shear analysis Fire				
V_{d}	=	-8.13	kN	
				$f_{r,k}$ = 1.25 N/mm ²
				γ_m = 1.00 -
				k_{mod} = 1.00 -
				k_{β} = 1.15 -
$T_{r,d}$	=	0.12	N/mm ² <	$f_{r,d}$ = 1.44 N/mm ² ✓
Utilization ratio				8%

Service limit state design (SLS) - design results

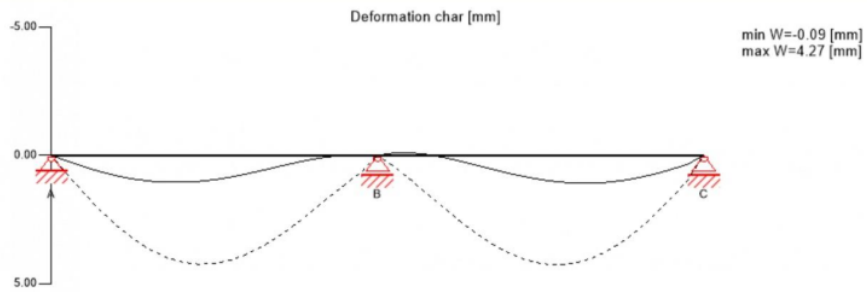

© 2024 - Calculatis by Stora Enso - Version 7.09.0
Any use of results of the software is only allowed, if the results have been verified and approved regarding completeness and correctness by a project structural/building physics engineer. For more information see the Terms of Use.



Service limit state design (SLS) - design results

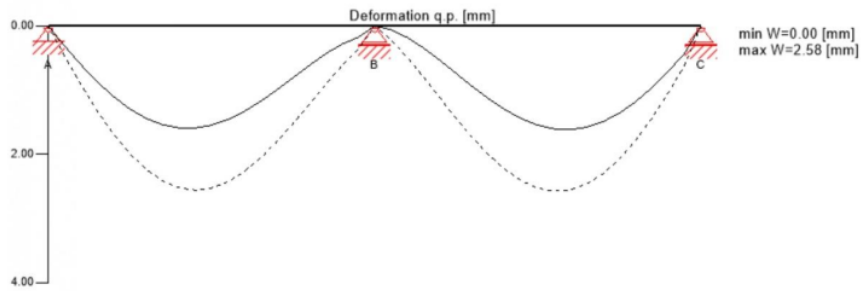

$w_{stat} = w[char]$

Field	K_{def}	Limit [-]	w_{limit} [mm]	$w_{calc.}$ [mm]	Ratio
1	0.8	L/300	15.0	4.2	28%
2	0.8	L/300	15.0	4.3	28%

$w_{im} = w[char] + w[q.p.] \cdot k_{def}$

Field	K_{def}	Limit [-]	w_{limit} [mm]	$w_{calc.}$ [mm]	Ratio
1	0.8	L/250	18.0	6.3	35%
2	0.8	L/250	18.0	6.3	35%

$w_{net,fin} = w[q.p.] + w[q.p.] \cdot k_{def}$

Field	K_{def}	Limit [-]	w_{limit} [mm]	$w_{calc.}$ [mm]	Ratio
1	0.8	L/300	15.0	4.6	31%
2	0.8	L/300	15.0	4.6	31%



Vibration analysis

General

Total mass	10.55 [t]
Tributary width	2.4 [m]
Stiffness Longitudinal direction	3648.0 [kNm ²]
Stiffness Cross direction	448.0 [kNm ²]
Modal damping	1.0 [%]
α	0.0 [-]
Man weight	700.0 [N]
Modal mass	2550.8 [kg]

Analysis

Criterion	Calc.	Class I	Class II	Class I	Class II	Cl. I	Cl. II
Frequency criterion min	9.678 [Hz]	4.5 [Hz]	4.5 [Hz]	46 %	46 %	✓	✓
Frequency criterion	9.678 [Hz]	8.0 [Hz]	6.0 [Hz]	83 %	62 %	✓	✓
Acceleration criterion	0.114 [m/s ²]	0.05 [m/s ²]	0.1 [m/s ²]	229 %	114 %		
Stiffness criterion	0.215 [mm]	0.25 [mm]	0.5 [mm]	86 %	43 %	✓	✓

Support reaction

Load case category	k_{mod}	A_V	B_V	C_V
			[kN]	
self-weight structure	0.6	1.36	4.47	1.36
		1.36	4.47	1.36
dead load	0.6	2.56	8.39	2.56
		2.56	8.39	2.56
live load cat. A: domestic, residential areas	0.8	3.95	11.18	3.95
		-0.55	0.00	-0.55

Reference documents for this analysis

English title	Description
EN 338	EN 338 - Structural timber ? Strength classes
EN 1995-1-1	EN 1995-1-1 - Eurocode 5: Design of timber structures - Part 1-1: General - Common rules and rules for buildings
ETA-14/0349	European Technical Assessment ETA-14/0349
Expertise Rolling shear - no edge gluing, H.J. Blass	Expertise on Rolling shear for CLT
EN 1995-1-2	EN 1995-1-2 - Eurocode 5 — Design of timber structures — Part 1-2: General — Structural fire design
Technical expertise 122/2011/02: analysis of load bearing capacity and separation performance of CLT elements	Verification of the load bearing capacity and the insulation criterion of CLT structures with Stora Enso CLT



Marija Gulam
University of Zagreb,
Faculty of Civil
Engineering

12/12

Reference documents for this analysis

English title	Description
Technical expertise 2434/2012 - BB: failure time t_f of gypsum fire boards (GKF) according to ON B 3410	Expertise on failure time t_f of gypsum wall fire boards according to ON B3410 and gypsum wall boards type DF according to EN 520
EN 1990	EN 1990 - Eurocode 1 Basis of structural design
ÖNorm B 1995-1-1 NA	ÖNORM EN 1995-1-1 - Austria - National Annex – Nationally determined parameters – Eurocode 5: Design of timber structures – Part 1-1: General-Common rules and rules for buildings
ÖNorm B 1995-1-2 NA	ÖNORM EN 1995-1-2 - Austria - National Annex - Eurocode 5: Design of timber structures ? Part 1-2: General ? Structural fire design ? National specifications concerning ÖNORM EN 1995-1-2, national comments and national supplements
Fire safety in timber buildings - technical guideline for Europe	Fire safety in timber buildings - technical guideline for Europe; publishes by SP Technical Research Institute of Sweden
National specifications concerning ÖNORM EN 1995-1-2, national comments and national supplements, chapter 12	ÖNORM EN 1995-1-2 - National specifications concerning ÖNORM EN 1995-1-2, national comments and national supplements, chapter 12
Expertise Rolling shear, H.J. Blass	Expertise on rolling shear strength and rolling shear modulus of CLT panels
ÖNORM EN 1995-1-1_NA, chapter 7.3	ÖNORM EN 1995-1-1 - Austria - National Annex – Nationally determined parameters – Eurocode 5: Design of timber structures – Part 1-1: General-Common rules and rules for buildings; chapter 7.3

Disclaimer

The software was created to assist engineers in their daily business. The software is an engineering software that is dealing with a very complex matter of structural analysis and building physics analysis. Therefore, this software shall only be operated by skilled, experienced engineers, with a deep understanding of structural engineering and building physics related to timber structures. The user of the software is obliged to check all input values, no matter if they were given by the user or given by default by the software and all results for plausibility. The use of the results of the software should not be relied upon as the basis for any decision or action. Any use of results of the software is only allowed, if the results have been verified and approved regarding completeness and correctness by a project structural/building physics engineer. The user has the possibility to make print-outs from the software. Any modification of those are not allowed. Stora Enso Wood Products GmbH does not assume any warranty regarding the software. The software has been developed with utmost diligence, nevertheless Stora Enso Wood Products GmbH, neither expressly nor implicitly, provides any warranty in terms of accuracy, validity, timeliness and completeness of information and data created by the software. Stora Enso Wood Products GmbH does also not assume any warranty for the general usability of the software, its suitability for a special purpose or for the compatibility of the software with the ones of third party producers or providers. Stora Enso Wood Products GmbH is only liable for damages caused by gross negligence or intent through Stora Enso Wood Products GmbH; the liability for slight negligence is excluded. This does not apply to personal injury. Under the aforementioned conditions Stora Enso Wood Products GmbH is as well not liable for operational failures or the loss of programs and/or data of the user's data processing system. Applicable Law: These terms of use shall be governed by the laws of Austria excluding however any conflict of laws rules and any laws regarding the Convention of the International Sale of Goods (CISG).

© 2024 - Calculatis by Stora Enso - Version 7.09.0
Any use of results of the software is only allowed, if the results have been verified and approved regarding completeness and correctness by a project structural/building physics engineer. For more information see the Terms of Use.

2.5.3 Čelična greda



Marija Gulam
University of Zagreb,
Faculty of Civil
Engineering

1/7

System

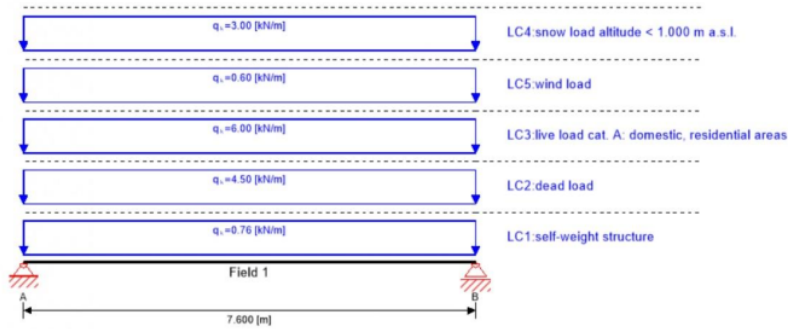

Global utilization ratio		78 %
ULS	42 %	SLS 78 %

Section

Name	Height	Width	t_f	t_w	Area	I_y	I_z	W_y	W_z	I_w	I_d	i_y	i_z	$W_{y,pl}$	$W_{z,pl}$
	[mm]	[mm]	[mm]	[mm]	[cm ²]	[cm ⁴]	[cm ⁴]	[cm ³]	[cm ³]	[cm ⁶]	[cm ⁴]	[cm]	[cm]	[cm ³]	[cm ³]
HE-A 280	270	280	13	8	97.26	13670	4763	1013	340.2	785400	62.1	1.186	0.7	1112	518.1

Material values

Material	$f_{m,k}$	$f_{t0,k}$	$E_{0,mean}$	G_{mean}
	[N/mm ²]	[N/mm ²]	[N/mm ²]	[N/mm ²]
Steel S355	355.00	510.00	210,000.0	80,700.00

Load

Load case groups

Load case category	Type	Duration	Kmod	γ_{inf}	γ_{sup}	ψ_0	ψ_1	ψ_2
LC1 self-weight structure	G	permanent	1	1	1.35	1	1	1
LC2 dead load	G	permanent	1	1	1.35	1	1	1

© 2024 - Calculatis by Stora Enso - Version 7.09.0
Any use of results of the software is only allowed, if the results have been verified and approved regarding completeness and correctness by a project structural/building physics engineer. For more information see the Terms of Use.



Load case groups									
Load case category	Type	Duration	K _{mod}	γ _{inf}	γ _{sup}	ψ ₀	ψ ₁	ψ ₂	
LC3 live load cat. A: domestic, residential areas	Q	medium term	1	0	1.5	0.7	0.5	0.3	
LC4 snow load altitude < 1.000 m a.s.l.	Q	short term	1	0	1.5	0.5	0.2	0	
LC5 wind load	Q	short term	1	0	1.5	0.6	0.2	0	

LC1:self-weight structure

continuous load

Field	Load at start
	[kN/m]
1	0.76

LC2:dead load

continuous load

Field	Load at start
	[kN/m]
1	4.50

LC3:live load cat. A: domestic, residential areas

continuous load

Field	Load at start
	[kN/m]
1	6.00

LC4:snow load altitude < 1.000 m a.s.l.



continuous load	
Field	Load at start [kN/m]
1	3.00

LC5:wind load

continuous load	
Field	Load at start [kN/m]
1	0.60

ULS Combinations

	Combination rule
LCO1	$1.35/1.00 * LC1 + 1.35/1.00 * LC2$
LCO2	$1.35/1.00 * LC1 + 1.35/1.00 * LC2 + 1.50/0.00 * LC3$
LCO3	$1.35/1.00 * LC1 + 1.35/1.00 * LC2 + 1.50/0.00 * LC3 + 1.50/0.00 * 0.50 * LC4$
LCO4	$1.35/1.00 * LC1 + 1.35/1.00 * LC2 + 1.50/0.00 * LC3 + 1.50/0.00 * 0.50 * LC4 + 1.50/0.00 * 0.60 * LC5$
LCO5	$1.35/1.00 * LC1 + 1.35/1.00 * LC2 + 1.50/0.00 * LC4$
LCO6	$1.35/1.00 * LC1 + 1.35/1.00 * LC2 + 1.50/0.00 * LC4 + 1.50/0.00 * 0.70 * LC3$
LCO7	$1.35/1.00 * LC1 + 1.35/1.00 * LC2 + 1.50/0.00 * LC4 + 1.50/0.00 * 0.70 * LC3 + 1.50/0.00 * 0.60 * LC5$
LCO8	$1.35/1.00 * LC1 + 1.35/1.00 * LC2 + 1.50/0.00 * LC5$
LCO9	$1.35/1.00 * LC1 + 1.35/1.00 * LC2 + 1.50/0.00 * LC5 + 1.50/0.00 * 0.70 * LC3$
LCO10	$1.35/1.00 * LC1 + 1.35/1.00 * LC2 + 1.50/0.00 * LC5 + 1.50/0.00 * 0.70 * LC3 + 1.50/0.00 * 0.50 * LC4$

ULS Combinations Fire

	Combination rule
LCO11	$1.00/1.00 * LC1 + 1.00/1.00 * LC2$
LCO12	$1.00/1.00 * LC1 + 1.00/1.00 * LC2 + 1.00/0.00 * 0.30 * LC3$
LCO13	$1.00/1.00 * LC1 + 1.00/1.00 * LC2 + 1.00/0.00 * 0.30 * LC3 + 1.00/0.00 * 0.00 * LC4$
LCO14	$1.00/1.00 * LC1 + 1.00/1.00 * LC2 + 1.00/0.00 * 0.30 * LC3 + 1.00/0.00 * 0.00 * LC4 + 1.00/0.00 * 0.00 * LC5$

© 2024 - Calculatis by Stora Enso - Version 7.09.0
Any use of results of the software is only allowed, if the results have been verified and approved regarding completeness and correctness by a project structural/building physics engineer. For more information see the Terms of Use.



ULS Combinations Fire

Combination rule	
LCO15	$1.00/1.00 * LC1 + 1.00/1.00 * LC2 + 1.00/0.00 * 0.00 * LC4$
LCO16	$1.00/1.00 * LC1 + 1.00/1.00 * LC2 + 1.00/0.00 * 0.00 * LC4 + 1.00/0.00 * 0.30 * LC3$
LCO17	$1.00/1.00 * LC1 + 1.00/1.00 * LC2 + 1.00/0.00 * 0.00 * LC4 + 1.00/0.00 * 0.30 * LC3 + 1.00/0.00 * 0.00 * LC5$
LCO18	$1.00/1.00 * LC1 + 1.00/1.00 * LC2 + 1.00/0.00 * 0.00 * LC5$
LCO19	$1.00/1.00 * LC1 + 1.00/1.00 * LC2 + 1.00/0.00 * 0.00 * LC5 + 1.00/0.00 * 0.30 * LC3$
LCO20	$1.00/1.00 * LC1 + 1.00/1.00 * LC2 + 1.00/0.00 * 0.00 * LC5 + 1.00/0.00 * 0.30 * LC3 + 1.00/0.00 * 0.00 * LC4$

SLS Characteristic Combination

Combination rule	
LCO21	$1.00/1.00 * LC1 + 1.00/1.00 * LC2$
LCO22	$1.00/1.00 * LC1 + 1.00/1.00 * LC2 + 1.00/0.00 * LC3 + 1.00/0.00 * 0.50 * LC4 + 1.00/0.00 * 0.60 * LC5$
LCO23	$1.00/1.00 * LC1 + 1.00/1.00 * LC2 + 1.00/0.00 * LC4 + 1.00/0.00 * 0.70 * LC3 + 1.00/0.00 * 0.60 * LC5$
LCO24	$1.00/1.00 * LC1 + 1.00/1.00 * LC2 + 1.00/0.00 * LC5 + 1.00/0.00 * 0.70 * LC3 + 1.00/0.00 * 0.50 * LC4$

SLS Quasi-permanent Combination

Combination rule	
LCO25	$1.00/1.00 * LC1 + 1.00/1.00 * LC2$
LCO26	$1.00/1.00 * LC1 + 1.00/1.00 * LC2 + 1.00/0.00 * 0.30 * LC3 + 1.00/0.00 * 0.00 * LC4 + 1.00/0.00 * 0.00 * LC5$
LCO27	$1.00/1.00 * LC1 + 1.00/1.00 * LC2 + 1.00/0.00 * 0.00 * LC4 + 1.00/0.00 * 0.30 * LC3 + 1.00/0.00 * 0.00 * LC5$
LCO28	$1.00/1.00 * LC1 + 1.00/1.00 * LC2 + 1.00/0.00 * 0.00 * LC5 + 1.00/0.00 * 0.30 * LC3 + 1.00/0.00 * 0.00 * LC4$

Flexural design					
Q _{kj} =	3		Comb.	LCO4	
M _{Ed} =	136.43	kNm	M _{Rd} =	359.62	kNm
Ratio	38	%		100	%
					✓
Utilization ratio					38%

© 2024 - Calculatis by Stora Enso - Version 7.09.0
Any use of results of the software is only allowed, if the results have been verified and approved regarding completeness and correctness by a project structural/building physics engineer. For more information see the Terms of Use.



Shear analysis						
Q _{KI} =	3		Comb.	LCO4		
V _{Ed} =	71.80	kN	V _{Rd} =	650.54	kN	
Ratio	11	%	<	100	%	✓
Utilization ratio						11%

Flexural design + Shear analysis						
Q _{KI} =	3		Comb.	LCO4		
V _{Ed} =	7.18	kN	V _{Rd} =	650.54	kN	
M _{Ed} =	135.06	kNm	M _{Rd} =	359.62	kNm	
Ratio	38	%	<	100	%	✓
Utilization ratio						38%

Lateral torsional buckling design						
Q _{KI} =	3		Comb.	LCO4		
N _{yEd} =	0.00	kN	N _{yRd} =	0.00	kN	
N _{zEd} =	0.00	kN	N _{zRd} =	0.00	kN	
M _{yEd} =	136.43	kNm	M _{yRd} =	322.69	kNm	
Ratio	42	%	<	100	%	✓
Utilization ratio						42%

Service limit state design (SLS) - design results

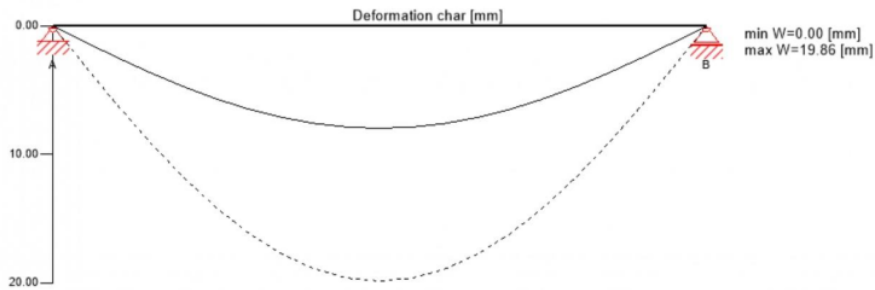

© 2024 - Calculatis by Stora Enso - Version 7.09.0
Any use of results of the software is only allowed, if the results have been verified and approved regarding completeness and correctness by a project structural/building physics engineer. For more information see the Terms of Use.



Service limit state design (SLS) - design results

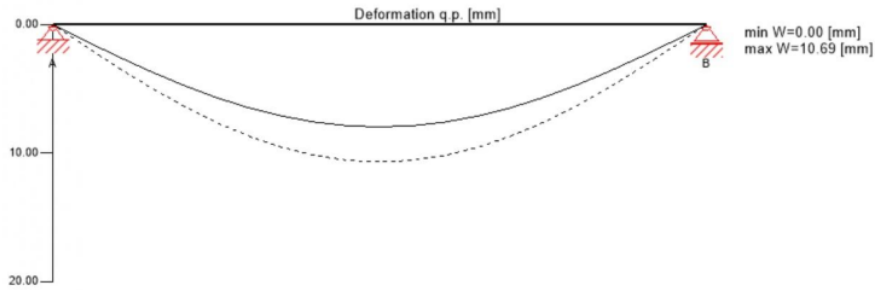

w _{inst} = w[char]				
Field	Limit	w _{limit}	w _{calc.}	Ratio
	[-]	[mm]	[mm]	
1	L/300	25.3	19.9	78%

Support reaction			
Load case category	k _{mod}	A _V	B _V
		[kN]	
self-weight structure	1	2.90	2.90
		2.90	2.90
dead load	1	17.10	17.10
		17.10	17.10
live load cat. A: domestic, residential areas	1	22.80	22.80
		0.00	0.00
snow load altitude < 1.000 m a.s.l.	1	11.40	11.40
		0.00	0.00
wind load	1	2.28	2.28
		0.00	0.00

© 2024 - Calculatis by Stora Enso - Version 7.09.0
Any use of results of the software is only allowed, if the results have been verified and approved regarding completeness and correctness by a project structural/building physics engineer. For more information see the Terms of Use.



Marija Gulam
University of Zagreb,
Faculty of Civil
Engineering

Reference documents for this analysis

English title	Description
EN 1993-1-1	EN 1993-1-1 - Eurocode 3: Design of steel structures - Part 1-1: General rules and rules for buildings
EN 1990	EN 1990 - Eurocode ? Basis of structural design

Disclaimer

The software was created to assist engineers in their daily business. The software is an engineering software that is dealing with a very complex matter of structural analysis and building physics analysis. Therefore, this software shall only be operated by skilled, experienced engineers, with a deep understanding of structural engineering and building physics related to timber structures. The user of the software is obliged to check all input values, no matter if they were given by the user or given by default by the software and all results for plausibility. The use of the results of the software should not be relied upon as the basis for any decision or action. Any use of results of the software is only allowed, if the results have been verified and approved regarding completeness and correctness by a project structural/building physics engineer. The user has the possibility to make print-outs from the software. Any modification of those are not allowed. Stora Enso Wood Products GmbH does not assume any warranty regarding the software. The software has been developed with utmost diligence, nevertheless Stora Enso Wood Products GmbH, neither expressly nor implicitly, provides any warranty in terms of accuracy, validity, timeliness and completeness of information and data created by the software. Stora Enso Wood Products GmbH does also not assume any warranty for the general usability of the software, its suitability for a special purpose or for the compatibility of the software with the ones of third party producers or providers. Stora Enso Wood Products GmbH is only liable for damages caused by gross negligence or intent through Stora Enso Wood Products GmbH; the liability for slight negligence is excluded. This does not apply to personal injury. Under the aforementioned conditions Stora Enso Wood Products GmbH is as well not liable for operational failures or the loss of programs and/or data of the user's data processing system. Applicable Law: These terms of use shall be governed by the laws of Austria excluding however any conflict of laws rules and any laws regarding the Convention of the International Sale of Goods (CISG).

2.5.4 Zid s otvorom

Marija Gulam



Model:
diplomski_zgradaA1

Date: 20.8.2024 Page: 1/9
Sheet: 1

TIMBER

1 Timber Design

1.1 DESIGN SITUATIONS

DS No.	EN 1990 Base + Timber CEN 2010-0	To Design	Active	EN 1995 HRN 2015-03	Combinations to Design for Enumeration Method
1	ULS (STR/GEO) - Permanent and transient - Eq. 6.10	<input checked="" type="checkbox"/>	<input checked="" type="checkbox"/>	ULS (STR/GEO) - Permanent and transient	All
2	SLS - Characteristic	<input checked="" type="checkbox"/>	<input checked="" type="checkbox"/>	SLS - Characteristic	All
3	SLS - Quasi-permanent	<input checked="" type="checkbox"/>	<input checked="" type="checkbox"/>	SLS - Quasi-permanent 1	All
4	SLS - Frequent base	<input checked="" type="checkbox"/>	<input checked="" type="checkbox"/>	SLS - Vibration	All
5	SLS - Quasi-permanent base	<input checked="" type="checkbox"/>	<input checked="" type="checkbox"/>	SLS - Quasi-permanent 1	All
6	Seismic/Mass Combination - psi-EJ	<input type="checkbox"/>	<input checked="" type="checkbox"/>	ULS (STR/GEO) - Accidental	
7	ULS (STR/GEO) - Seismic	<input checked="" type="checkbox"/>	<input checked="" type="checkbox"/>	ULS (STR/GEO) - Permanent and transient	All

1.2 MATERIALS

Legend
 Concrete Settings
 Stiffness modification

Material No.	Name	To Design	Material Type	Options	Comment
1	C24 BBS XL	<input checked="" type="checkbox"/>	Timber	<input checked="" type="checkbox"/>	
2	C24 BBS XL	<input checked="" type="checkbox"/>	Timber	<input checked="" type="checkbox"/>	
3	GL32h	<input checked="" type="checkbox"/>	Timber	<input checked="" type="checkbox"/>	
4	C35/45	<input checked="" type="checkbox"/>	Concrete	<input checked="" type="checkbox"/>	

1.3 THICKNESSES

Thick. No.	Name	Type	Material	To Design	Use Other Thick. d [mm] for Design
1	Layers d : 220.0 mm Layers: 7	Layers		<input checked="" type="checkbox"/>	--
2	Layers d : 140.0 mm Layers: 5	Layers		<input checked="" type="checkbox"/>	--
3	Uniform d : 200.0 mm 4 - C35/45	Uniform	4	<input checked="" type="checkbox"/>	--

1.4 Results

1.4.1 DESIGN RATIOS ON SURFACES BY DESIGN SITUATION

Timber Design

Design Situation	Surface No.	Point No.	Point Coordinates [m]	Loading No.	Layer No.	Layer Side	Design Check Ratio η [-]	Type	Description	
DS1	103	4869	6.659 21.176 -0.471	CO46	2	Bottom	0.000	UL0100.00	Ultimate Limit State Negligible stresses	
			6.660 24.176 -2.500	CO2	2	Top	0.061	UL1100.00	Ultimate Limit State Tension along grain	
			6.659 21.176 -3.300	CO3	1	Top	0.247	UL1300.00	Ultimate Limit State Compression along grain	
			6.659 21.176 -3.300	CO3	2	Top	0.153	UL3020.00	Ultimate Limit State Shear in xz-plane	
			6.659 21.176 -3.300	CO3	3	Middle	0.063	UL3110.00	Ultimate Limit State Shear in xy-plane Failure	
			4923	6.659 27.176 -2.829	CO3	5	Bottom	0.121	UL3400.00	Ultimate Limit State Shear in xz-plane and xy-plane
			1961	6.660 26.176 -2.500	CO3	2	Bottom	0.009	UL4100.00	Ultimate Limit State Bending along grain
			387	6.659 27.176 -3.300	CO2	2	Top	0.128	UL5100.00	Ultimate Limit State Bending and tension along grain
			4914	6.660 24.176 -2.500	CO15	2	Top	0.056	UL5100.00	Ultimate Limit State Bending and compression along grain
			377	6.659 21.176 -3.300	CO3	1	Top	0.302	UL6100.00	Ultimate Limit State Bending and compression along grain
DS2	103	377	6.659 21.176 -3.300	CO48			0.000	SE0500.00	Serviceability Negligible deflections	
			6.660 24.176 -2.500	CO90			0.026	SE5000.01	Serviceability Combination of actions 'Characteristic' Deflection in z-direction	
DS3	103	377	6.659 21.176 -3.300	CO95			0.000	SE0500.00	Serviceability Negligible deflections	
			6.660 24.176 -2.500	CO137			0.022	SE5000.02	Serviceability Combination of actions 'Quasi-permanent 1' Deflection in z-direction	



Dimenzioniranje nosivih dijelova konstrukcije

Marija Gulam



Model:

diplomski_zgradaA1

Date 20.8.2024 Page 2/9

Sheet 1

TIMBER

1.4.1 DESIGN RATIOS ON SURFACES BY DESIGN SITUATION

Timber Design

Design Situation	Surface No.	Point No.	Point Coordinates [m]			Loading No.	Layer No.	Side	Design Check Ratio η [-]		Type	Description
DS4	SLS - Frequent base 103	377	6.659	21.176	-3.300	CO142			0.000	✓	SE0500.00	Serviceability Negligible deflections
		4914	6.660	24.176	-2.500	CO155			0.023	✓	SE6000.00	Serviceability Vibration in z-direction
DS5	SLS - Quasi-permanent base 103	377	6.659	21.176	-3.300	CO158			0.000	✓	SE0500.00	Serviceability Negligible deflections
DS7	ULS (STR/GEO) - Seismic 103	4914	6.660	24.176	-2.500	RC1	1	Top	0.000	✓	UL0100.00	Ultimate Limit State Negligible stresses
		1963	6.659	26.176	0.000	RC1	1	Top	0.200	✓	UL1100.00	Ultimate Limit State Tension along grain
			6.659	26.176	0.000	RC3	1	Top	0.257	✓	UL1300.00	Ultimate Limit State Compression along grain
		387	6.659	27.176	-3.300	RC2	2	Top	0.073	✓	UL3010.00	Ultimate Limit State Shear in yz-plane
			6.659	27.176	-3.300	RC2	3	Middle	0.030	✓	UL3020.00	Ultimate Limit State Shear in xz-plane
		4891	6.659	27.176	-1.414	RC3	1	Top	0.138	✓	UL3110.00	Ultimate Limit State Shear in xy-plane Failure mechanism 1
			6.659	27.176	-1.414	RC3	1	Middle	0.019	✓	UL3400.00	Ultimate Limit State Shear in xz-plane and xy-plane
		388	6.659	27.176	0.000	RC3	1	Top	0.040	✓	UL4100.00	Ultimate Limit State Bending along grain
		1963	6.659	26.176	0.000	RC1	1	Top	0.225	✓	UL5100.00	Ultimate Limit State Bending and tension along grain
			6.659	26.176	0.000	RC3	5	Bottom	0.282	✓	UL6100.00	Ultimate Limit State Bending and compression along grain

1.4.2 DESIGN RATIOS ON SURFACES BY THICKNESS

Timber Design

Thick. No.	Surface No.	Point No.	Point Coordinates [m]			Design Situation	Loading No.	Layer No.	Side	Design Check Ratio η [-]		Type	Description
2	Layers d : 140.0 mm Layers: 5 103	4869	6.659	21.176	-0.471	DS1	CO46	2		0.000	✓	UL0100.00	Ultimate Limit State Negligible stresses
		1963	6.659	26.176	0.000	DS7	RC1	1	Top	0.200	✓	UL1100.00	Ultimate Limit State Tension along grain
			6.659	26.176	0.000	DS7	RC3	1	Top	0.257	✓	UL1300.00	Ultimate Limit State Compression along grain
		377	6.659	21.176	-3.300	DS1	CO3	2	Top	0.153	✓	UL3010.00	Ultimate Limit State Shear in yz-plane
			6.659	21.176	-3.300	DS1	CO3	3	Middle	0.063	✓	UL3020.00	Ultimate Limit State Shear in xz-plane
		4891	6.659	27.176	-1.414	DS7	RC3	1	Top	0.138	✓	UL3110.00	Ultimate Limit State Shear in xy-plane Failure mechanism 1
			6.659	27.176	-1.414	DS7	RC3	1	Middle	0.019	✓	UL3400.00	Ultimate Limit State Shear in xz-plane and xy-plane
		387	6.659	27.176	-3.300	DS1	CO2	2	Top	0.128	✓	UL4100.00	Ultimate Limit State Bending along grain
		1963	6.659	26.176	0.000	DS7	RC1	1	Top	0.225	✓	UL5100.00	Ultimate Limit State Bending and tension
		377	6.659	21.176	-3.300	DS1	CO3	1	Top	0.302	✓	UL6100.00	Ultimate Limit State Bending and compression along grain
			6.659	21.176	-3.300	DS2	CO48			0.000	✓	SE0500.00	Serviceability Negligible deflections
		4914	6.660	24.176	-2.500	DS2	CO90			0.026	✓	SE5000.00	Serviceability Combination of actions
			6.660	24.176	-2.500	DS3	CO137			0.022	✓	SE5000.02	Serviceability Combination of actions 'Quasi-permanent 1' Deflection in z-direction
			6.660	24.176	-2.500	DS4	CO155			0.023	✓	SE6000.00	Serviceability Vibration in z-direction

1.4.3 DESIGN RATIOS ON SURFACES BY SURFACE

Timber Design

Surface No.	Point No.	Point Coordinates [m]			Design Situation	Loading No.	Layer No.	Side	Design Check Ratio η [-]		Type	Description
103	520,527,2933,2931,2932,2940,534,2604 Standard Plane 2 - Layers d : 140.0 mm Layers: 5 4869	6.659	21.176	-0.471	DS1	CO46	2	Bottom	0.000	✓	UL0100.00	Ultimate Limit State Negligible stresses
		1963	6.659	26.176	0.000	DS7	RC1	1	Top	0.200	✓	UL1100.00



Marija Gulam



Model:
diplomski_zgradaA1

Date 20.8.2024 Page 3/9
Sheet 1

TIMBER

1.4.3 DESIGN RATIOS ON SURFACES BY SURFACE

Timber Design

Surface No.	Point No.	Point Coordinates [m]			Design Situation	Loading No.	Layer		Design Check		Description
		X	Y	Z		No.	Side	Ratio η [-]	Type		
103		6.659	26.176	0.000	DS7	RC3	1	Top	0.257	UL1300.00	Ultimate Limit State Compression along grain
	377	6.659	21.176	-3.300	DS1	CO3	2	Top	0.153	UL3010.00	Ultimate Limit State Shear in yz-plane
		6.659	21.176	-3.300	DS1	CO3	3	Middle	0.063	UL3020.00	Ultimate Limit State Shear in xz-plane
	4891	6.659	27.176	-1.414	DS7	RC3	1	Top	0.138	UL3110.00	Ultimate Limit State Shear in xy-plane Failure mechanism 1
		6.659	27.176	-1.414	DS7	RC3	1	Middle	0.019	UL3400.00	Ultimate Limit State Shear in xz-plane and xy-plane
	387	6.659	27.176	-3.300	DS1	CO2	2	Top	0.128	UL4100.00	Ultimate Limit State Bending along grain
	1963	6.659	26.176	0.000	DS7	RC1	1	Top	0.225	UL5100.00	Ultimate Limit State Bending and tension along grain
	377	6.659	21.176	-3.300	DS1	CO3	1	Top	0.302	UL6100.00	Ultimate Limit State Bending and compression along grain
		6.659	21.176	-3.300	DS2	CO48			0.000	SE0500.00	Serviceability Negligible deflections
	4914	6.660	24.176	-2.500	DS2	CO90			0.026	SE5000.01	Serviceability Combination of actions 'Characteristic' Deflection in z-direction
		6.660	24.176	-2.500	DS3	CO137			0.022	SE5000.02	Serviceability Combination of actions 'Quasi-permanent' Deflection in z-direction
		6.660	24.176	-2.500	DS4	CO155			0.023	SE6000.00	Serviceability Vibration in z-direction

1.4.4 GOVERNING INTERNAL FORCES BY SURFACE

Timber Design

Surface No.	Point No.	Point Coordinates [m]			Design Situation	Loading No.	Moments [kNm/m]			Shear F. [kN/m]		Axial Forces [kN/m]			Design Check	Description	
		X	Y	Z			m_x	m_y	m_{xy}	V_x	V_y	N_x	N_y	N_{xy}	Ratio η [-]	Type	
103	4869	6.659	21.176	-0.471	DS1	CO46	0.016	-0.016	-0.007	-0.069	0.011	-106.975	-0.624	0.110	0.000	UL1010.00	Ultimate Limit State Negligible stresses
	1963	6.659	26.176	0.000	DS7	RC1	0.730	0.010	-0.024	0.040	0.003	266.104	37.612	38.499	0.200	UL1100.00	Ultimate Limit State Tension along grain
		6.659	26.176	0.000	DS7	RC3	0.722	0.009	0.032	0.036	0.003	240.786	37.389	-40.935	0.257	UL1300.00	Ultimate Limit State Compression along grain
	377	6.659	21.176	-3.300	DS1	CO3	2.616	-0.437	-0.651	-10.766	-0.337	-346.424	-10.224	8.133	0.153	UL3010.00	Ultimate Limit State Shear in yz-plane
		6.659	21.176	-3.300	DS1	CO3	2.616	-0.437	-0.651	-10.766	-0.337	-346.424	-10.224	8.133	0.063	UL3020.00	Ultimate Limit State Shear in xz-plane
	4891	6.659	27.176	-1.414	DS7	RC3	0.332	0.195	0.059	0.935	0.591	38.153	2.704	-49.930	0.138	UL3110.00	Ultimate Limit State Shear in xy-plane Failure mechanism 1
		6.659	27.176	-1.414	DS7	RC3	0.332	0.195	0.059	0.935	0.591	38.153	2.704	-49.930	0.019	UL3400.00	Ultimate Limit State Shear in xz-plane and xy-plane
	387	6.659	27.176	-3.300	DS1	CO2	-0.309	1.181	0.523	-7.914	0.141	-290.679	-12.106	-10.525	0.128	UL4100.00	Ultimate Limit State Bending along grain
	1963	6.659	26.176	0.000	DS7	RC1	0.730	0.010	-0.024	0.040	0.003	266.104	37.612	38.499	0.225	UL5100.00	Ultimate Limit State Bending and tension along grain
	377	6.659	21.176	-3.300	DS1	CO3	2.616	-0.437	-0.651	-10.766	-0.337	-346.424	-10.224	8.133	0.302	UL6100.00	Ultimate Limit State compression along grain
		6.659	21.176	-3.300	DS2	CO48	0.867	-0.145	-0.246	-3.682	-0.118	-129.674	-3.797	2.798	0.000	SE0500.00	Serviceability Negligible deflections
	4914	6.660	24.176	-2.500	DS2	CO90	0.009	0.029	0.000	-0.035	-0.001	-0.080	14.081	-0.007	0.026	SE5000.01	Serviceability Combination



Marija Gulam



Model:
diplomski_zgradaA1

Date 20.8.2024 Page 4/9
Sheet 1

TIMBER

1.4.4 GOVERNING INTERNAL FORCES BY SURFACE

Timber Design

Surface No.	Point No.	Point Coordinates [m]			Design Situation	Loading No.	Moments [kNm/m]			Shear F. [kN/m]		Axial Forces [kN/m]			Design Check		Description
		X	Y	Z			m_x	m_y	m_{xy}	v_x	v_y	n_x	n_y	n_{xy}	Ratio η [-]	Type	
103																	of actions 'Characteristic' Deflection in z-direction
						CO137	0.009	0.029	0.000	-0.035	-0.002	-0.113	20.899	-0.010	0.022	SE500 0.02	Serviceability Combination of actions 'Quasi-permanent 1' Deflection in z-direction
		6.660	24.176	-2.500	DS4	CO155	0.002	0.005	0.000	-0.007	-0.001	-0.052	11.944	-0.005	0.023	SE600 0.00	Serviceability Vibration in z-direction



Marija Gulam



Model:
diplomski_zgradaA1

Date 20.8.2024 Page 5/9
Sheet 1

MODEL

1.5 SURFACE NO. 103 | DS7 | RC3 | MESH NODE NO. 1963 | ELEMENT NO. 4196 | UL6100

Timber Design

Design Check UL6100 | EN 1995 | HRN | 2015-03

Ultimate Limit State
Bending and compression along grain

$$f_{c,0,d} = k_{mod} \cdot \frac{f_{c,0,k}}{\gamma_M}$$

$$= 1.10 \cdot \frac{21.000 \text{ N/mm}^2}{1.20}$$

$$= 19.250 \text{ N/mm}^2$$

$$f_{m,0,d} = k_{mod} \cdot \frac{f_{m,0,k}}{\gamma_M}$$

$$= 1.10 \cdot \frac{24.000 \text{ N/mm}^2}{1.20}$$

$$= 22.000 \text{ N/mm}^2$$

$$\eta = \frac{|\sigma_{c,0,d}|}{f_{c,0,d}} + \frac{|\sigma_{b,0,d}|}{f_{m,0,d}}$$

$$= \frac{|-4.945 \text{ N/mm}^2|}{19.250 \text{ N/mm}^2} + \frac{|-0.531 \text{ N/mm}^2|}{22.000 \text{ N/mm}^2}$$

$$= 0.281$$

$$\eta = 0.281 \leq 1 \quad \checkmark$$

- $f_{c,0,d}$ Design compressive strength along grain
- k_{mod} Modification factor
- $f_{c,0,k}$ Characteristic compressive strength along grain
- γ_M Partial factor
- $f_{m,0,d}$ Design bending strength along grain
- $f_{m,0,k}$ Characteristic bending strength along grain
- $\sigma_{c,0,d}$ Design compressive stress along grain
- $\sigma_{b,0,d}$ Design bending stress along grain



Marija Gulam



Model:

diplomski_zgradaA1

Date 20.8.2024

Page 6/9

Sheet 1

MODEL

1.6 SURFACE NO. 103 | DS7 | RC3 | MESH NODE NO. 1963 | ELEMENT NO. 4196 | UL1300

Timber Design

Design Check UL1300 | EN 1995 | HRN | 2015-03

Ultimate Limit State
Compression along grain

$$f_{c,0,d} = k_{mod} \cdot \frac{f_{c,0,k}}{\gamma_M}$$

$$= 1.10 \cdot \frac{21.000 \text{ N/mm}^2}{1.20}$$

$$= 19.250 \text{ N/mm}^2$$

$$\eta = \frac{|\sigma_{c,0,d}|}{f_{c,0,d}}$$

$$= \frac{|-4.945 \text{ N/mm}^2|}{19.250 \text{ N/mm}^2}$$

$$= 0.257$$

$$\eta = 0.257 \leq 1 \quad \checkmark$$

- $f_{c,0,d}$ Design compressive strength along grain
- k_{mod} Modification factor
- $f_{c,0,k}$ Characteristic compressive strength along grain
- γ_M Partial factor
- $\sigma_{c,0,d}$ Design compressive stress along grain



Marija Gulam



Model:

diplomski_zgradaA1

Date

20.8.2024

Page

7/9

Sheet

1

MODEL

1.7 SURFACE NO. 103 | DS2 | CO90 | MESH NODE NO. 4914 | ELEMENT NO. 4219 | SE5000.01

Timber Design

Design Check SE5000.01 | EN 1995 | HRN | 2015-03

Serviceability

Combination of actions 'Characteristic' | Deflection in z-direction

Design situation: Characteristic
Surface type: Double-supported

$$w_{inst,limit,z} = \frac{l}{l/w_{inst,limit,z}}$$

$$= \frac{6.000 \text{ m}}{300.00}$$

$$= 20.0 \text{ mm}$$

$$\eta = \frac{|w_{inst,z}|}{w_{inst,limit,z}}$$

$$= \frac{[0.5 \text{ mm}]}{20.0 \text{ mm}}$$

$$= 0.026$$

$$\eta = 0.026 \leq 1 \quad \checkmark$$

$w_{inst,limit,z}$ Limit value of deflection

l Reference length

$l/w_{inst,limit,z}$ Limit value criterion

$w_{inst,z}$ Deflection



Marija Gulam



Model:

diplomski_zgradaA1

Date

20.8.2024

Page

8/9

Sheet

1

MODEL

1.8 SURFACE NO. 103 | DS1 | CO1 | MESH NODE NO. 1963 | ELEMENT NO. 4196 | UL6100

Timber Design

Design Check UL6100 | EN 1995 | HRN | 2015-03

Ultimate Limit State
Bending and compression along grain

$$f_{c,0,d} = k_{mod} \cdot \frac{f_{c,0,k}}{\gamma_M}$$

$$= 0.60 \cdot \frac{21.000 \text{ N/mm}^2}{1.20}$$

$$= 10.500 \text{ N/mm}^2$$

$$f_{m,0,d} = k_{mod} \cdot \frac{f_{m,0,k}}{\gamma_M}$$

$$= 0.60 \cdot \frac{24.000 \text{ N/mm}^2}{1.20}$$

$$= 12.000 \text{ N/mm}^2$$

$$\eta = \frac{|\sigma_{c,0,d}|}{f_{c,0,d}} + \frac{|\sigma_{b,0,d}|}{f_{m,0,d}}$$

$$= \frac{|-1.371 \text{ N/mm}^2|}{10.500 \text{ N/mm}^2} + \frac{|-0.015 \text{ N/mm}^2|}{12.000 \text{ N/mm}^2}$$

$$= 0.132$$

$$\eta = 0.132 \leq 1 \quad \checkmark$$

- $f_{c,0,d}$ Design compressive strength along grain
- k_{mod} Modification factor
- $f_{c,0,k}$ Characteristic compressive strength along grain
- γ_M Partial factor
- $f_{m,0,d}$ Design bending strength along grain
- $f_{m,0,k}$ Characteristic bending strength along grain
- $\sigma_{c,0,d}$ Design compressive stress along grain
- $\sigma_{b,0,d}$ Design bending stress along grain



Marija Gulam



Model:
diplomski_zgradaA1

Date: 20.8.2024 Page: 9/9
Sheet: 1

MODEL

1.9 SURFACE NO. 103 | DS1 | CO1 | MESH NODE NO. 1963 | ELEMENT NO. 4196 | UL1300

Timber Design

Design Check UL1300 | EN 1995 | HRN | 2015-03

Ultimate Limit State
Compression along grain

$$\begin{aligned} f_{c,0,d} &= k_{mod} \cdot \frac{f_{c,0,k}}{\gamma_M} \\ &= 0.60 \cdot \frac{21.000 \text{ N/mm}^2}{1.20} \\ &= 10.500 \text{ N/mm}^2 \end{aligned}$$

$$\begin{aligned} \eta &= \frac{|\sigma_{c,0,d}|}{f_{c,0,d}} \\ &= \frac{|-1.371 \text{ N/mm}^2|}{10.500 \text{ N/mm}^2} \\ &= 0.131 \end{aligned}$$

$$\eta = 0.131 \leq 1 \quad \checkmark$$

- $f_{c,0,d}$ Design compressive strength along grain
- k_{mod} Modification factor
- $f_{c,0,k}$ Characteristic compressive strength along grain
- γ_M Partial factor
- $\sigma_{c,0,d}$ Design compressive stress along grain



2.5.5 Stupovi

Marija Gulam



Model:
diplomski_zgradaA1

Date: 20.8.2024 Page: 1/6
Sheet: 1

MODEL

1 Types for Timber Design

1.1 SERVICE CLASSES

Class No.	Members	Member Sets	Surfaces	Surface Sets	Service Class Type	Comment
1	Service Class 1 (Members : 1-13 Surfaces : 1-14,20-31,43-53,70-78,97-104,106-114,116-118,120-129,139-142,154-157,159-192,204-206,208-214,216-223,225-231,233-236,257,258,262-273,298-304,315-343,348-364,366-381,383-427,526)					
1-13			1-14,20-31,43-53,70-78,97-104,106-114,116-118,120-129,139-142,154-157,159-192,204-206,208-214,216-223,225-231,233-236,257,258,262-273,298-304,315-343,348-364,366-381,383-427,526		1 - Dry	

2 Timber Design

2.1 DESIGN SITUATIONS

DS No.	EN 1990 Base + Timber CEN 2010-0	To Design	Active	EN 1995 HRN 2015-03	Combinations to Design for Enumeration Method
1	ULS (STR/GEO) - Permanent and transient - Eq. 6.10	<input checked="" type="checkbox"/>	<input checked="" type="checkbox"/>	ULS (STR/GEO) - Permanent and transient	All
2	SLS - Characteristic	<input checked="" type="checkbox"/>	<input checked="" type="checkbox"/>	SLS - Characteristic	All
3	SLS - Quasi-permanent	<input checked="" type="checkbox"/>	<input checked="" type="checkbox"/>	SLS - Quasi-permanent 1	All
4	SLS - Frequent base	<input checked="" type="checkbox"/>	<input checked="" type="checkbox"/>	SLS - Vibration	All
5	SLS - Quasi-permanent base	<input checked="" type="checkbox"/>	<input checked="" type="checkbox"/>	SLS - Quasi-permanent 1	All
6	Seismic/Mass Combination - psi-E _i	<input type="checkbox"/>	<input checked="" type="checkbox"/>	ULS (STR/GEO) - Accidental	All
7	ULS (STR/GEO) - Seismic	<input checked="" type="checkbox"/>	<input checked="" type="checkbox"/>	ULS (STR/GEO) - Permanent and transient	All

2.2 SECTIONS

Legend
 Warping stiffness deactivated

Section No.	Name	Material	To Design	Section Type	Use Other Section for Design	Options
1	R_M1 200/200	3	<input checked="" type="checkbox"/>	Parametric - Massive I	--	<input checked="" type="checkbox"/>

2.3 Results

2.3.1 DESIGN RATIOS ON MEMBERS BY MEMBER

Timber Design

Member No.	Location x [m]	Stress Point No.	Design Situation	Loading No.	Design Check Ratio η [-]	Type	Description
Beam 1 - R_M1 200/200 L: 3.300 m							
1	0.000 =	1	DS1	CO3	0.778 ✓		
		4	DS7	RC3	0.015 ✓	SP3100.00	Section Proof Shear in z-axis acc. to 6.1.7 Rectangular section
	1.238	2	DS1	CO210	0.049 ✓	SP3200.00	Section Proof Shear in y-axis acc. to 6.1.7 Rectangular section
		1	DS7	RC2	0.297 ✓	SP6100.00	Section Proof Bending about y-axis and compressive axial force acc. to 6.2.4
	3.300 =	1	DS1	CO3	0.747 ✓	SP6200.00	Section Proof Bending about z-axis and compressive axial force acc. to 6.2.4
		1	DS1	CO3	0.722 ✓	SP6300.00	Section Proof Biaxial bending and compressive axial force acc. to 6.2.4
	0.000 =		DS2	CO48	0.000 ✓	SE0100.01	Serviceability Negligible deflection Combination of actions 'Characteristic'
			DS3	CO95	0.000 ✓	SE0100.02	Serviceability Negligible deflection Combination of actions 'Quasi-permanent 1'
			DS4	CO142	0.000 ✓	SE0100.10	Serviceability Negligible deflection of vibration
	2.063		DS2	CO212	0.065 ✓	SE1100.01	Serviceability Combination of actions 'Characteristic' y-direction acc. to 7.2
			DS3	CO104	0.068 ✓	SE1100.02	Serviceability Combination of actions 'Quasi-permanent 1' y-direction acc. to 7.2
	1.650 = _y		DS2	CO212	0.008 ✓	SE1200.01	Serviceability Combination of actions 'Characteristic' z-direction acc. to 7.2
			DS3	CO104	0.008 ✓	SE1200.02	Serviceability Combination of actions 'Quasi-permanent 1' z-direction acc. to 7.2
	2.063		DS4	CO144	0.097 ✓	SE2100.00	Serviceability Vibration in y-direction
		DS4	CO144	0.011 ✓	SE2200.00	Serviceability Vibration in z-direction	



Marija Gulam



Model:

diplomski_zgradaA1

Date 20.8.2024

Page 2/6

Sheet 1

MODEL

2.4 MEMBER NO. 1 | DS1 | CO3 | 0.000 M | STRESS POINT NO. 1 | SP1200

Timber Design

Design Check SP1200 | EN 1995 | HRN | 2015-03

Section Proof
Compression along grain acc. to 6.1.4

$$f_{c,0,d} = k_{mod} \cdot \frac{f_{c,0,k}}{\gamma_M}$$

$$= 0.80 \cdot \frac{32.000 \text{ N/mm}^2}{1.25}$$

$$= 20.480 \text{ N/mm}^2$$

$$\eta = \frac{|\sigma_{c,0,d}|}{f_{c,0,d}}$$

$$= \frac{|-15.935 \text{ N/mm}^2|}{20.480 \text{ N/mm}^2}$$

$$= 0.778$$

$$\eta = 0.778 \leq 1 \quad \checkmark$$

2.4.1, Eq. 2.14

6.1.4, Eq. 6.2

- $f_{c,0,d}$ Design compressive strength
- k_{mod} Modification factor
- $f_{c,0,k}$ Characteristic compressive strength
- γ_M Partial factor
- $\sigma_{c,0,d}$ Design compressive stress



Marija Gulam



Model:
diplomski_zgradaA1

Date 20.8.2024 Page 3/6
Sheet 1

MODEL

2.5 MEMBER NO. 1 | DS1 | CO3 | 0.000 M | STRESS POINT NO. 3 | SP6300

Timber Design

Design Check SP6300 | EN 1995 | HRN | 2015-03

Section Proof
Biaxial bending and compressive axial force acc. to 6.2.4

$$f_{c,0,d} = k_{mod} \cdot \frac{f_{c,0,k}}{\gamma_M}$$

$$= 0.80 \cdot \frac{32.000 \text{ N/mm}^2}{1.25}$$

$$= 20.480 \text{ N/mm}^2$$

2.4.1, Eq. 2.14

$$f_{m,y,d} = k_{mod} \cdot \frac{f_{m,y,k}}{\gamma_M}$$

$$= 0.80 \cdot \frac{32.000 \text{ N/mm}^2}{1.25}$$

$$= 20.480 \text{ N/mm}^2$$

2.4.1, Eq. 2.14

$$f_{m,z,d} = k_{mod} \cdot \frac{f_{m,z,k}}{\gamma_M}$$

$$= 0.80 \cdot \frac{32.000 \text{ N/mm}^2}{1.25}$$

$$= 20.480 \text{ N/mm}^2$$

2.4.1, Eq. 2.14

$$\eta_1 = \sqrt{\left(\frac{\sigma_{c,0,d}}{f_{c,0,d}} \right)^2 + \frac{\sigma_{m,y,d}}{f_{m,y,d}} + k_m \cdot \frac{\sigma_{m,z,d}}{f_{m,z,d}}}$$

$$= \sqrt{\left(\frac{-15.935 \text{ N/mm}^2}{20.480 \text{ N/mm}^2} \right)^2 + \frac{-0.213 \text{ N/mm}^2}{20.480 \text{ N/mm}^2} + 0.70 \cdot \frac{-1.320 \text{ N/mm}^2}{20.480 \text{ N/mm}^2}}$$

$$= 0.661$$

6.2.4, Eq. 6.19

$$\eta_2 = \sqrt{\left(\frac{\sigma_{c,0,d}}{f_{c,0,d}} \right)^2 + k_m \cdot \frac{\sigma_{m,y,d}}{f_{m,y,d}} + \frac{\sigma_{m,z,d}}{f_{m,z,d}}}$$

$$= \sqrt{\left(\frac{-15.935 \text{ N/mm}^2}{20.480 \text{ N/mm}^2} \right)^2 + 0.70 \cdot \frac{-0.213 \text{ N/mm}^2}{20.480 \text{ N/mm}^2} + \frac{-1.320 \text{ N/mm}^2}{20.480 \text{ N/mm}^2}}$$

$$= 0.677$$

6.2.4, Eq. 6.20

$$\eta = \max(\eta_1, \eta_2)$$

$$= \max(0.661, 0.677)$$

$$= 0.677$$

6.2.4

$$\eta = 0.677 \leq 1 \quad \checkmark$$

- $f_{c,0,d}$ Design compressive strength
- k_{mod} Modification factor
- $f_{c,0,k}$ Characteristic compressive strength
- γ_M Partial factor
- $f_{m,y,d}$ Design bending strength
- $f_{m,y,k}$ Characteristic bending strength
- $f_{m,z,d}$ Design bending strength
- $f_{m,z,k}$ Characteristic bending strength
- η_1 Design ratio 1
- $\sigma_{c,0,d}$ Design compressive stress
- $\sigma_{m,y,d}$ Design bending stress
- k_m Redistribution factor
- $\sigma_{m,z,d}$ Design bending stress
- η_2 Design ratio 2



Marija Gulam



Model:
diplomski_xgradaA1

Date 20.8.2024 Page 4/6
Sheet 1

MODEL

2.6 MEMBER NO. 1 | D52 | CO212 | 2.063 M | SE1100.01

Timber Design

Design Check SE1100.01 | EN 1995 | HRN | 2015-03

Serviceability
Combination of actions 'Characteristic' | y-direction acc. to 7.2

Segment type in y-axis: Beam

$$w_{inst,limit,y} = \frac{l}{300.00}$$

$$= \frac{3.300 \text{ m}}{300.00}$$

$$= 11.0 \text{ mm}$$

$$\eta = \frac{|w_{inst,y}|}{w_{inst,limit,y}}$$

$$= \frac{|0.7 \text{ mm}|}{11.0 \text{ mm}}$$

$$= 0.065$$

$$\eta = 0.065 \leq 1 \quad \checkmark$$

7.2

$w_{inst,limit,y}$ Limit value of deflection
 l Reference length
 $l / w_{inst,limit,y}$ Limit value criterion
 $w_{inst,y}$ Deflection



Marija Gulam



Model:
diplomski_zgradaA1

Date: 20.8.2024 Page: 5/6
Sheet: 1

MODEL

2.7 MEMBER NO. 1 | DS7 | RC1 | 0.000 M | STRESS POINT NO. 1 | SP1200

Timber Design

Design Check SP1200 | EN 1995 | HRN | 2015-03

Section Proof
Compression along grain acc. to 6.1.4

$$f_{c,0,d} = k_{mod} \cdot \frac{f_{c,0,k}}{\gamma_M}$$

$$= 1.10 \cdot \frac{32.000 \text{ N/mm}^2}{1.25}$$

$$= 28.160 \text{ N/mm}^2$$

$$\eta = \frac{|\sigma_{c,0,d}|}{f_{c,0,d}}$$

$$= \frac{|-12.361 \text{ N/mm}^2|}{28.160 \text{ N/mm}^2}$$

$$= 0.439$$

$$\eta = 0.439 \leq 1 \quad \checkmark$$

2.4.1, Eq. 2.14

6.1.4, Eq. 6.2

- $f_{c,0,d}$ Design compressive strength
- k_{mod} Modification factor
- $f_{c,0,k}$ Characteristic compressive strength
- γ_M Partial factor
- $\sigma_{c,0,d}$ Design compressive stress



Marija Gulam



Model:
diplomski_zgradaA1

Date 20.8.2024 Page 6/6
Sheet 1

MODEL

2.8 MEMBER NO. 1 | DS7 | RC1 | 0.000 M | STRESS POINT NO. 3 | SP6300

Timber Design

Design Check SP6300 | EN 1995 | HRN | 2015-03

Section Proof
Biaxial bending and compressive axial force acc. to 6.2.4

$$f_{c,0,d} = k_{mod} \cdot \frac{f_{c,0,k}}{\gamma_M}$$

$$= 1.10 \cdot \frac{32.000 \text{ N/mm}^2}{1.25}$$

$$= 28.160 \text{ N/mm}^2$$

2.4.1, Eq. 2.14

$$f_{m,y,d} = k_{mod} \cdot \frac{f_{m,y,k}}{\gamma_M}$$

$$= 1.10 \cdot \frac{32.000 \text{ N/mm}^2}{1.25}$$

$$= 28.160 \text{ N/mm}^2$$

2.4.1, Eq. 2.14

$$f_{m,z,d} = k_{mod} \cdot \frac{f_{m,z,k}}{\gamma_M}$$

$$= 1.10 \cdot \frac{32.000 \text{ N/mm}^2}{1.25}$$

$$= 28.160 \text{ N/mm}^2$$

2.4.1, Eq. 2.14

$$\eta_1 = \left| -\left(\frac{\sigma_{c,0,d}}{f_{c,0,d}}\right)^2 + \frac{\sigma_{m,y,d}}{f_{m,y,d}} + k_m \cdot \frac{\sigma_{m,z,d}}{f_{m,z,d}} \right|$$

$$= \left| -\left(\frac{-12.361 \text{ N/mm}^2}{28.160 \text{ N/mm}^2}\right)^2 + \frac{-1.981 \text{ N/mm}^2}{28.160 \text{ N/mm}^2} + 0.70 \cdot \frac{-1.116 \text{ N/mm}^2}{28.160 \text{ N/mm}^2} \right|$$

$$= 0.291$$

6.2.4, Eq. 6.19

$$\eta_2 = \left| -\left(\frac{\sigma_{c,0,d}}{f_{c,0,d}}\right)^2 + k_m \cdot \frac{\sigma_{m,y,d}}{f_{m,y,d}} + \frac{\sigma_{m,z,d}}{f_{m,z,d}} \right|$$

$$= \left| -\left(\frac{-12.361 \text{ N/mm}^2}{28.160 \text{ N/mm}^2}\right)^2 + 0.70 \cdot \frac{-1.981 \text{ N/mm}^2}{28.160 \text{ N/mm}^2} + \frac{-1.116 \text{ N/mm}^2}{28.160 \text{ N/mm}^2} \right|$$

$$= 0.282$$

6.2.4, Eq. 6.20

$$\eta = \max(\eta_1, \eta_2)$$

$$= \max(0.291, 0.282)$$

$$= 0.291$$

6.2.4

$$\eta = 0.291 \leq 1 \quad \checkmark$$

- $f_{c,0,d}$ Design compressive strength
- k_{mod} Modification factor
- $f_{c,0,k}$ Characteristic compressive strength
- γ_M Partial factor
- $f_{m,y,d}$ Design bending strength
- $f_{m,y,k}$ Characteristic bending strength
- $f_{m,z,d}$ Design bending strength
- $f_{m,z,k}$ Characteristic bending strength
- η_1 Design ratio 1
- $\sigma_{c,0,d}$ Design compressive stress
- $\sigma_{m,y,d}$ Design bending stress
- k_m Redistribution factor
- $\sigma_{m,z,d}$ Design bending stress
- η_2 Design ratio 2



2.6 Dimenzioniranje karakterističnih spojeva

2.6.1 Spoj CLT zida s betonskom pločom

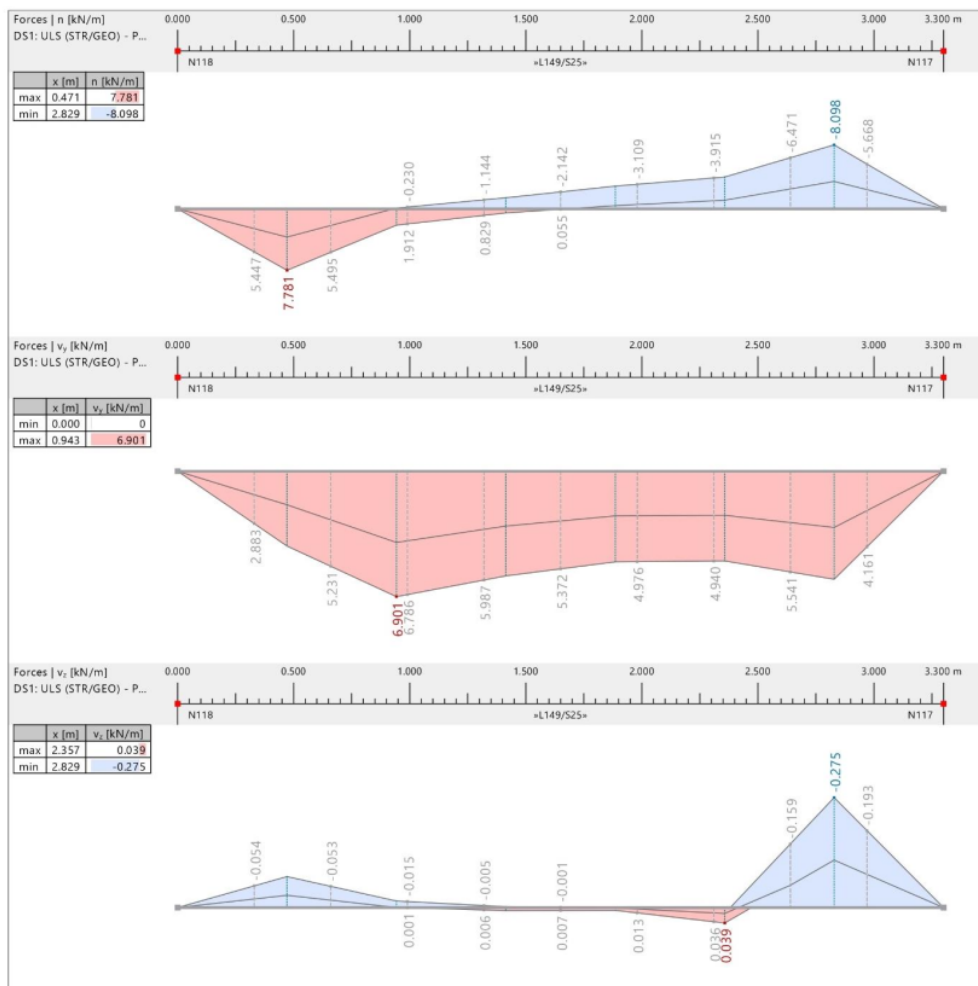

Slika 27. Dijagrami unutarnjih sila na spoju između CLT zida i betonske ploče



Connection

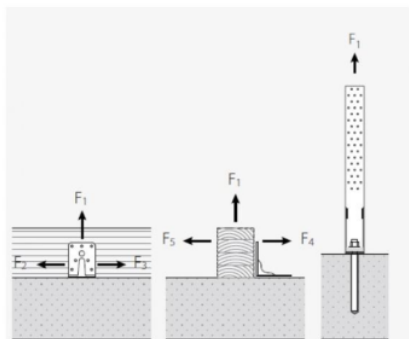

F_1	7.78	kN
F_{23}	6.91	kN
F_{45}	0.275	kN
K_{mod}	0.8	-
Connectors	AG922 / Nail CNA 4,0x50	
e_{45}		mm

Design F_1						
$F_{k,1}$	7.8	kN		$R_{k,1,Holz}$	15.3	kN
				$R_{k,1,Stahl}$		kN
				γ_m	1.3	-
				k_{mod}	0.80	-
$F_{d,1}$	7.8	kN	<	$R_{d,1}$	9.4	kN ✓
Utilization ratio						83%

Design F_{23}						
$F_{k,23}$	6.9	kN		$R_{k,23,Holz}$	24.1	kN
				γ_m	1.3	-
				k_{mod}	0.80	-
$F_{d,23}$	6.9	kN	<	$R_{d,23}$	14.8	kN ✓
Utilization ratio						47%

© 2024 - Calculatis by Stora Enso - Version 7.10.0
Any use of results of the software is only allowed, if the results have been verified and approved regarding completeness and correctness by a project structural/building physics engineer. For more information see the Terms of Use.



Design F_{45}					
$F_{k,45} =$	0.3	kN	$R_{k,45,Hotz} =$	24.8	kN
			$\gamma_m =$	1.3	-
			$k_{mod} =$	0.80	-
$F_{d,45} =$	0.3	kN	$R_{d,45} =$	15.3	kN ✓
Utilization ratio					2%

Design forces for anchorage to concrete

Design values, having "in" in the index refer to an inner anchor position
Design values, having "out" in the index refer to an outer anchor position
See technical approvals and assessment documents

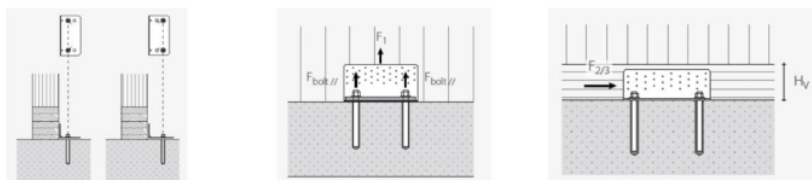

Reference documents for this analysis

English title	Description
EN 338	EN 338 - Structural timber ? Strength classes
EN 1995-1-1	EN 1995-1-1 - Eurocode 5: Design of timber structures - Part 1-1: General - Common rules and rules for buildings
EN 1990	EN 1990 - Eurocode ? Basis of structural design
ÖNorm B 1995-1-1 NA	ÖNORM EN 1995-1-1 - Austria - National Annex – Nationally determined parameters – Eurocode 5: Design of timber structures – Part 1-1: General-Common rules and rules for buildings
ÖNorm B 1995-1-2 NA	ÖNORM EN 1995-1-2 - Austria - National Annex - Eurocode 5: Design of timber structures ? Part 1-2: General ? Structural fire design ? National specifications concerning ÖNORM EN 1995-1-2, national comments and national supplements
ETA-11/0030	ETA-11/0030 European Technical Approval; Rothoblaas; Self-tapping screws for use in timber structures
ETA-12/0063	SFS intec AG; Self-tapping screws for use in timber constructions
ETA-12/0062	SFA intec AG; ETA-12/0062; selftapping screws for use in timber constructions

© 2024 - Calculatis by Stora Enso - Version 7.10.0
Any use of results of the software is only allowed, if the results have been verified and approved regarding completeness and correctness by a project structural/building physics engineer. For more information see the Terms of Use.



Reference documents for this analysis

English title	Description
ETA-11/0086	GH Various Angle Brackets
ETA-09/0322	GH Various Angle Brackets
ETA-11/0496	Rotho Blaas TITAN Angle Brackets
ETA-11/0190	selftaping screw by Würth
ETA-12/0373	Schmid - Screws for use in timber constructions
ETA-12/0114	SPAX - Screws for use in timber constructions
ETA-21/0670	Simpson Strong-Tie® Structural screws SWW, SWC, TTUFS, TTSFS and TTZNFs
ETA-13/0796	Simpson Strong-Tie® screws ESCR/ESCR-S, ESCRC/ESCR-C-S., ESCRS, ESCRFTC, ESCRFT/FTZ, ESCRHD/HRD, ESCRT2R, SSTA and ESCRH
ETA-20/0773	Würth - DENEb Angle Brackets and plate connectors
ETA-08/0183	Würth - Typ A + Typ V Angle Bracket
ETA-14/0274	Würth - Hold down and storey connector

Disclaimer

The software was created to assist engineers in their daily business. The software is an engineering software that is dealing with a very complex matter of structural analysis and building physics analysis. Therefore, this software shall only be operated by skilled, experienced engineers, with a deep understanding of structural engineering and building physics related to timber structures. The user of the software is obliged to check all input values, no matter if they were given by the user or given by default by the software and all results for plausibility. The use of the results of the software should not be relied upon as the basis for any decision or action. Any use of results of the software is only allowed, if the results have been verified and approved regarding completeness and correctness by a project structural/building physics engineer. The user has the possibility to make print-outs from the software. Any modification of those are not allowed. Stora Enso Wood Products GmbH does not assume any warranty regarding the software. The software has been developed with utmost diligence, nevertheless Stora Enso Wood Products GmbH, neither expressly nor implicitly, provides any warranty in terms of accuracy, validity, timeliness and completeness of information and data created by the software. Stora Enso Wood Products GmbH does also not assume any warranty for the general usability of the software, its suitability for a special purpose or for the compatibility of the software with the ones of third party producers or providers. Stora Enso Wood Products GmbH is only liable for damages caused by gross negligence or intent through Stora Enso Wood Products GmbH; the liability for slight negligence is excluded. This does not apply to personal injury. Under the aforementioned conditions Stora Enso Wood Products GmbH is as well not liable for operational failures or the loss of programs and/or data of the user's data processing system. Applicable Law: These terms of use shall be governed by the laws of Austria excluding however any conflict of laws rules and any laws regarding the Convention of the International Sale of Goods (CISG).

© 2024 - Calculatis by Stora Enso - Version 7.10.0

Any use of results of the software is only allowed, if the results have been verified and approved regarding completeness and correctness by a project structural/building physics engineer. For more information see the Terms of Use.

CODES AND DIMENSIONS

TITAN S - TCS | CONCRETE-TO-TIMBER JOINTS

CODE	B [mm] [in]	P [mm] [in]	H [mm] [in]	holes [mm] [in]	$n_V \text{ } \varnothing 11$ $n_V \text{ } \varnothing 0,44$ [pcs]	s [mm] [in]	pcs
TCS240	240 9 1/2	123 4 13/16	130 5 1/8	4 x $\varnothing 17$ 4 x $\varnothing 0.67$	14	3 0.12	10

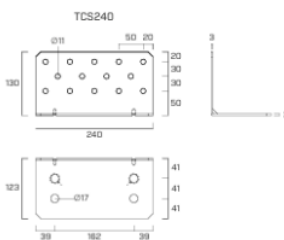
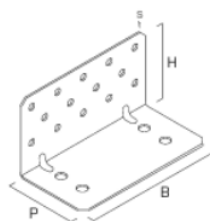

FASTENERS

type	description	d [mm]	support
HBS PLATE	pan head screw	8	
HBS PLATE EVO	C4 EVO pan head screw	8	
AB1	CE1 expansion anchor	16	
SKR	screw-in anchor	16	
VIN-FIX	vinyl ester chemical anchor	M16	
HYB-FIX	hybrid chemical anchor	M16	
EPO-FIX	epoxy chemical anchor	M16	

STRUCTURAL VALUES | TCS240 | TIMBER-TO-CONCRETE | F₄ | F₅ | F_{4/5}

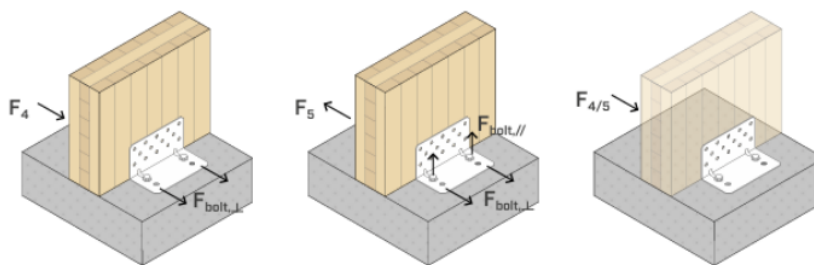

F ₄	TIMBER			STEEL		CONCRETE				
	fastening holes $\varnothing 11$ type	$\varnothing \times L$ [mm]	n_V [pcs]	$R_{4,k \text{ timber}}$ [kN]	$R_{4,k \text{ steel}}$ [kN]	Y_{steel}	fastening holes \varnothing [mm]	n_H [pcs]	k_{eL}	k_{eH}
TCS240	HBS PLATE	$\varnothing 8 \times 80$	14	21,1	18,1	Y_{M0}	M16	2	0,5	-

The group of 2 anchors must be verified for: $V_{Sd,y} = 2 \times k_{eL} \times F_{4,d}$

F ₅	TIMBER			STEEL		CONCRETE				
	fastening holes $\varnothing 11$ type	$\varnothing \times L$ [mm]	n_V [pcs]	$R_{5,k \text{ timber}}$ [kN]	$R_{5,k \text{ steel}}$ [kN]	Y_{steel}	fastening holes \varnothing [mm]	n_H [pcs]	k_{eL}	k_{eH}
TCS240	HBS PLATE	$\varnothing 8 \times 80$	14	17,1	4,3	Y_{M0}	M16	2	0,5	0,36

The group of 2 anchors must be verified for: $V_{Sd,y} = 2 \times k_{eL} \times F_{5,d}$; $N_{Sd,z} = 2 \times k_{eH} \times F_{5,d}$

F _{4/5} TWO ANGLE BRACKETS	TIMBER			STEEL		CONCRETE				
	fastening holes $\varnothing 11$ type	$\varnothing \times L$ [mm]	n_V [pcs]	$R_{4/5,k \text{ timber}}$ [kN]	$R_{4/5,k \text{ steel}}$ [kN]	Y_{steel}	fastening holes \varnothing [mm]	n_H [pcs]	k_{eL}	k_{eH}
TCS240	HBS PLATE	$\varnothing 8 \times 80$	14 + 14	27,4	18,8	Y_{M0}	M16	2 + 2	0,39	0,08

The group of 2 anchors must be verified for: $V_{Sd,y} = 2 \times k_{eL} \times F_{4/5,d}$; $N_{Sd,z} = 2 \times k_{eH} \times F_{4/5,d}$

Slika 28. Karakteristike odabranog spojnog sredstva TCS240 iz Rothblaas kataloga

CODES AND DIMENSIONS

WHT ANGLE BRACKET

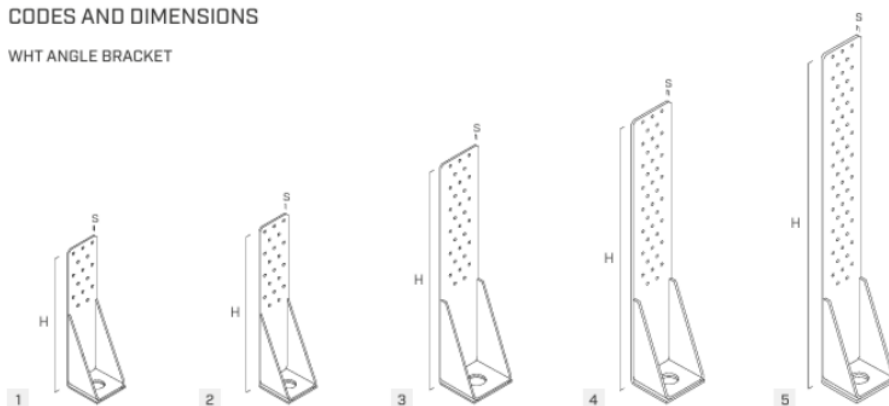

CODE	H	s	$n_v \text{ } \varnothing 5$	hole	H	s	$n_v \text{ } \varnothing .20$	hole	pcs
	[mm]	[mm]	[pcs]	[mm]	[in]	[in]	[pcs]	[in]	
1 WHT15	250	2.5	15	$\varnothing 23$	10	0.10	15	$\varnothing 0.91$	20
2 WHT20	290	3	20	$\varnothing 23$	11 7/16	0.12	20	$\varnothing 0.91$	20
3 WHT30	400	3	30	$\varnothing 29$	15 3/4	0.12	30	$\varnothing 1.14$	10
4 WHT40	480	4	40	$\varnothing 29$	19	0.16	40	$\varnothing 1.14$	10
5 WHT55	600	5	55	$\varnothing 29$	23 5/8	0.20	55	$\varnothing 1.14$	1

GEOMETRY

WHT		WHT15	WHT20	WHT30	WHT40	WHT55
Height	H [mm]	250	290	400	480	600
Base	B [mm]	60	60	80	80	80
Depth	P [mm]	62,5	63	73	74	75
Vertical flange thickness	s [mm]	2,5	3	3	4	5
Hole position in timber	c [mm]	140	140	170	170	170
Hole position in concrete	m [mm]	32,5	33	38	39	40
Flange holes	\varnothing_1 [mm]	5	5	5	5	5
Base hole	\varnothing_2 [mm]	23	23	29	29	29

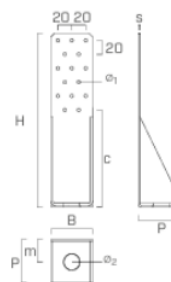

FASTENERS

type	description		d	support
			[mm]	
LBA	high bond nail		4	
LBS	round head screw		5	
LBS HARDWOOD	round head screw on hardwoods		5	
VIN-FIX	vinyl ester chemical anchor		M16-M20-M24	
HYB-FIX	hybrid chemical anchor		M16-M20-M24	
EPO-FIX	epoxy chemical anchor		M16-M20-M24	
KOS	hexagonal head bolt		M16-M20-M24	

Slika 29. Karakteristike odabranog spojnog sredstva WHT20 iz Rothoblaas kataloga

STRUCTURAL VALUES | TIMBER-TO-CONCRETE | F_1

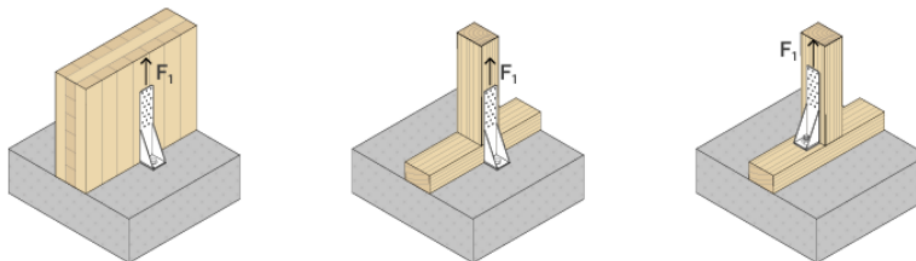

STRENGTH ON TIMBER SIDE | WIDE PATTERN | total fastening

CODE	type	TIMBER			STEEL				
		fastening holes $\varnothing 5$ [mm]	n_V [pcs]	$R_{1,k}$ timber [kN]	no washer $R_{1,k}$ steel [kN]	washer $R_{1,k}$ steel [kN]	Y_{steel}	no washer $K_{1,ser}$ [N/mm]	washer $K_{1,ser}$ [N/mm]
WHT15	LBA	$\varnothing 4 \times 60$		36,8					
	LBS	$\varnothing 5 \times 70$	15	35,6	30,0	40,0	Y_{MO}	5000	5880
	LBSH	$\varnothing 5 \times 50$		35,3					
WHT20	LBA	$\varnothing 4 \times 60$		48,1					
	LBS	$\varnothing 5 \times 70$	20	48,3	40,0	50,0	Y_{MO}	6667	7980
	LBSH	$\varnothing 5 \times 50$		47,9					
WHT30	LBA	$\varnothing 4 \times 60$		76,4					
	LBS	$\varnothing 5 \times 70$	30	73,7	-	70,0	Y_{MO}	-	11667
	LBSH	$\varnothing 5 \times 50$		73,1					
WHT40	LBA	$\varnothing 4 \times 60$		101,9					
	LBS	$\varnothing 5 \times 70$	40	96,5	-	90,0	Y_{MO}	-	15000
	LBSH	$\varnothing 5 \times 50$		95,8					
WHT55	LBA	$\varnothing 4 \times 60$		141,5					
	LBS	$\varnothing 5 \times 70$	55	132,1	-	120,0	Y_{MO}	-	20000
	LBSH	$\varnothing 5 \times 50$		131,0					

Slika 30. Karakteristike odabranog spojnog sredstva WHT20 iz Rothoblaas kataloga

Odabrana spojna sredstva TCS240 postavljaju se na razmaku od 50 cm, dok se kutnik WHT20 postavlja na rubovima, oko otvora te na svakom 5. razmaku.

2.6.2 Spoj CLT zidova

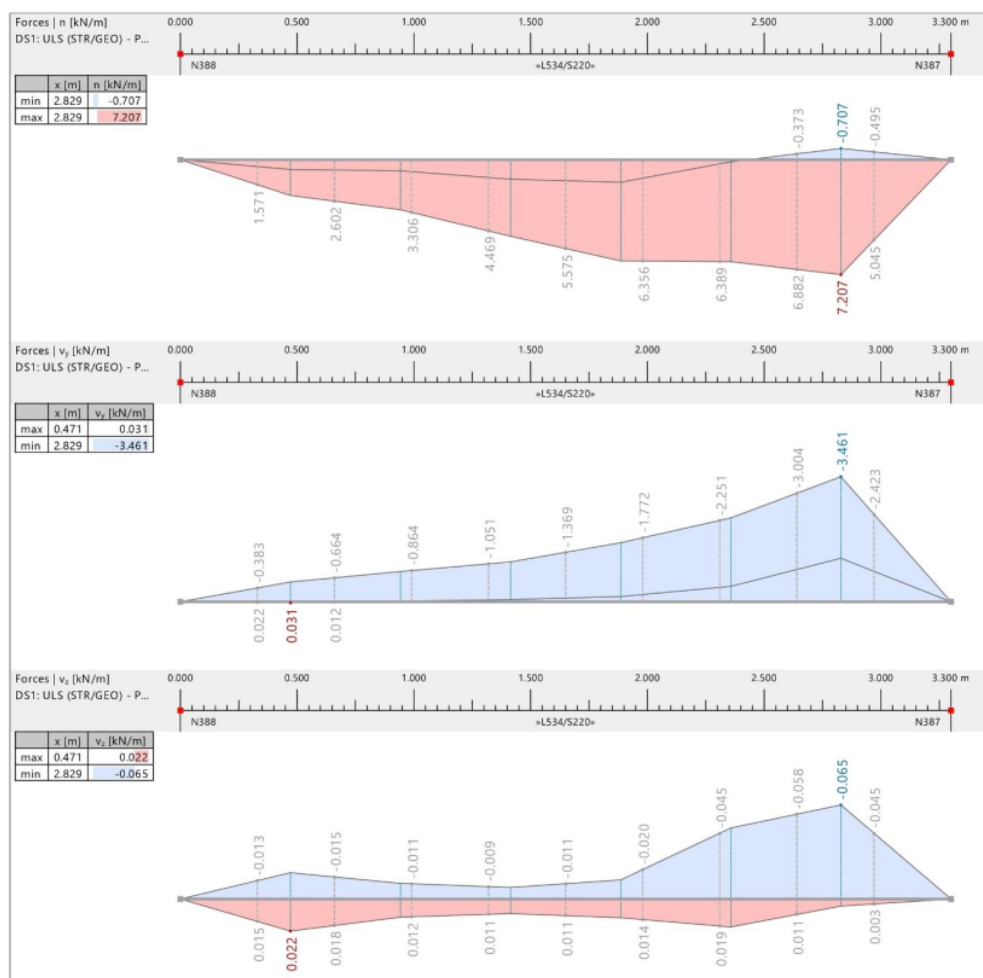

Slika 31. Dijagrami unutarnjih sila na spoju između zidova



Connection

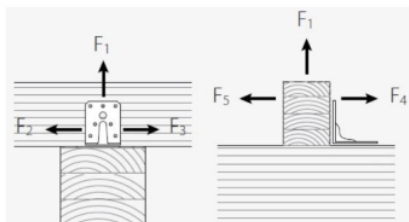

F_1
 F_{23}
 F_{45}
 K_{mod}
Connectors

7.207 kN
3.461 kN
0.065 kN
0.8 -
ABR255 / Nail CNA 4,0x50

Design F_1					
$F_{k,1} =$	7.2	kN	$R_{k,1,Holz} =$	17.1	kN
			$\gamma_m =$	1.3	-
			$K_{mod} =$	0.80	-
$F_{d,1} =$	7.2	kN	<	$R_{d,1} =$	10.5 kN ✓
Utilization ratio					69%

Design F_{23}					
$F_{k,23} =$	3.5	kN	$R_{k,23,Holz} =$	28.6	kN
			$\gamma_m =$	1.3	-
			$K_{mod} =$	0.80	-
$F_{d,23} =$	3.5	kN	<	$R_{d,23} =$	17.6 kN ✓
Utilization ratio					20%

Design F_{45}					
$F_{k,45} =$	0.1	kN	$R_{k,45,Holz} =$	11.5	kN
			$\gamma_m =$	1.3	-
			$K_{mod} =$	0.80	-
$F_{d,45} =$	0.1	kN	<	$R_{d,45} =$	7.1 kN ✓
Utilization ratio					1%



Reference documents for this analysis

English title	Description
EN 338	EN 338 - Structural timber ? Strength classes
EN 1995-1-1	EN 1995-1-1 - Eurocode 5: Design of timber structures - Part 1-1: General - Common rules and rules for buildings
EN 1990	EN 1990 - Eurocode ? Basis of structural design
ÖNorm B 1995-1-1 NA	ÖNORM EN 1995-1-1 - Austria - National Annex – Nationally determined parameters – Eurocode 5: Design of timber structures – Part 1-1: General-Common rules and rules for buildings
ÖNorm B 1995-1-2 NA	ÖNORM EN 1995-1-2 - Austria - National Annex - Eurocode 5: Design of timber structures ? Part 1-2: General ? Structural fire design ? National specifications concerning ÖNORM EN 1995-1-2, national comments and national supplements
ETA-11/0030	ETA-11/0030 European Technical Approval; Rothoblaas; Self-tapping screws for use in timber structures
ETA-12/0063	SFS intec AG; Self-tapping screws for use in timber constructions
ETA-12/0062	SFA intec AG; ETA-12/0062; selftapping screws for use in timber constructions
ETA-11/0086	GH Various Angle Brackets
ETA-09/0322	GH Various Angle Brackets
ETA-11/0496	Rotho Blaas TITAN Angle Brackets
ETA-11/0190	selftaping screw by Würth
ETA-12/0373	Schmid - Screws for use in timber constructions
ETA-12/0114	SPAX - Screws for use in timber constructions
ETA-21/0670	Simpson Strong-Tie® Structural screws SWW, SWC, TTUFS, TTSFS and TTZNFS
ETA-13/0796	Simpson Strong-Tie® screws ESCR/ESCR-S, ESCRC/ESCRC-S., ESCRS, ESCRFTC, ESCRFT/FTZ, ESCRHD/HRD, ESCRT2R, SSTA and ESCRH
ETA-20/0773	Würth - DENEb Angle Brackets and plate connectors
ETA-08/0183	Würth - Typ A + Typ V Angle Bracket
ETA-14/0274	Würth - Hold down and storey connector



Marija Gulam
University of Zagreb,
Faculty of Civil
Engineering

3/3

Disclaimer

The software was created to assist engineers in their daily business. The software is an engineering software that is dealing with a very complex matter of structural analysis and building physics analysis. Therefore, this software shall only be operated by skilled, experienced engineers, with a deep understanding of structural engineering and building physics related to timber structures. The user of the software is obliged to check all input values, no matter if they were given by the user or given by default by the software and all results for plausibility. The use of the results of the software should not be relied upon as the basis for any decision or action. Any use of results of the software is only allowed, if the results have been verified and approved regarding completeness and correctness by a project structural/building physics engineer. The user has the possibility to make print-outs from the software. Any modification of those are not allowed. Stora Enso Wood Products GmbH does not assume any warranty regarding the software. The software has been developed with utmost diligence, nevertheless Stora Enso Wood Products GmbH, neither expressly nor implicitly, provides any warranty in terms of accuracy, validity, timeliness and completeness of information and data created by the software. Stora Enso Wood Products GmbH does also not assume any warranty for the general usability of the software, its suitability for a special purpose or for the compatibility of the software with the ones of third party producers or providers. Stora Enso Wood Products GmbH is only liable for damages caused by gross negligence or intent through Stora Enso Wood Products GmbH; the liability for slight negligence is excluded. This does not apply to personal injury. Under the aforementioned conditions Stora Enso Wood Products GmbH is as well not liable for operational failures or the loss of programs and/or data of the user's data processing system. Applicable Law: These terms of use shall be governed by the laws of Austria excluding however any conflict of laws rules and any laws regarding the Convention of the International Sale of Goods (CISG).

© 2024 - Calculatis by Stora Enso - Version 7.10.0

Any use of results of the software is only allowed, if the results have been verified and approved regarding completeness and correctness by a project structural/building physics engineer. For more information see the Terms of Use.



Slika 32. Prikaz izvedenog spoja zidova i ploča od CLT-a sa spojnim sredstvom TCS240

CODES AND DIMENSIONS

TITAN S - TCS | CONCRETE-TO-TIMBER JOINTS

CODE	B	P	H	holes	$n_v \varnothing 11$	s		pcs
	[mm] [in]	[mm] [in]	[mm] [in]	[mm] [in]	$n_v \varnothing 0.44$ [pcs]	[mm] [in]		
TCS240	240 9 1/2	123 4 13/16	130 5 1/8	4 x $\varnothing 17$ 4 x $\varnothing 0.67$	14	3 0.12		10

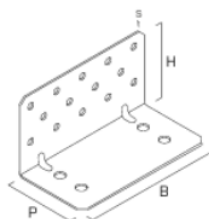

Slika 33. Karakteristike odabranog spojnog sredstva

Odabrano spojno sredstvo TCS240 postavlja se na razmaku od 50 cm.

2.6.3 Spoj CLT zida s CLT pločom

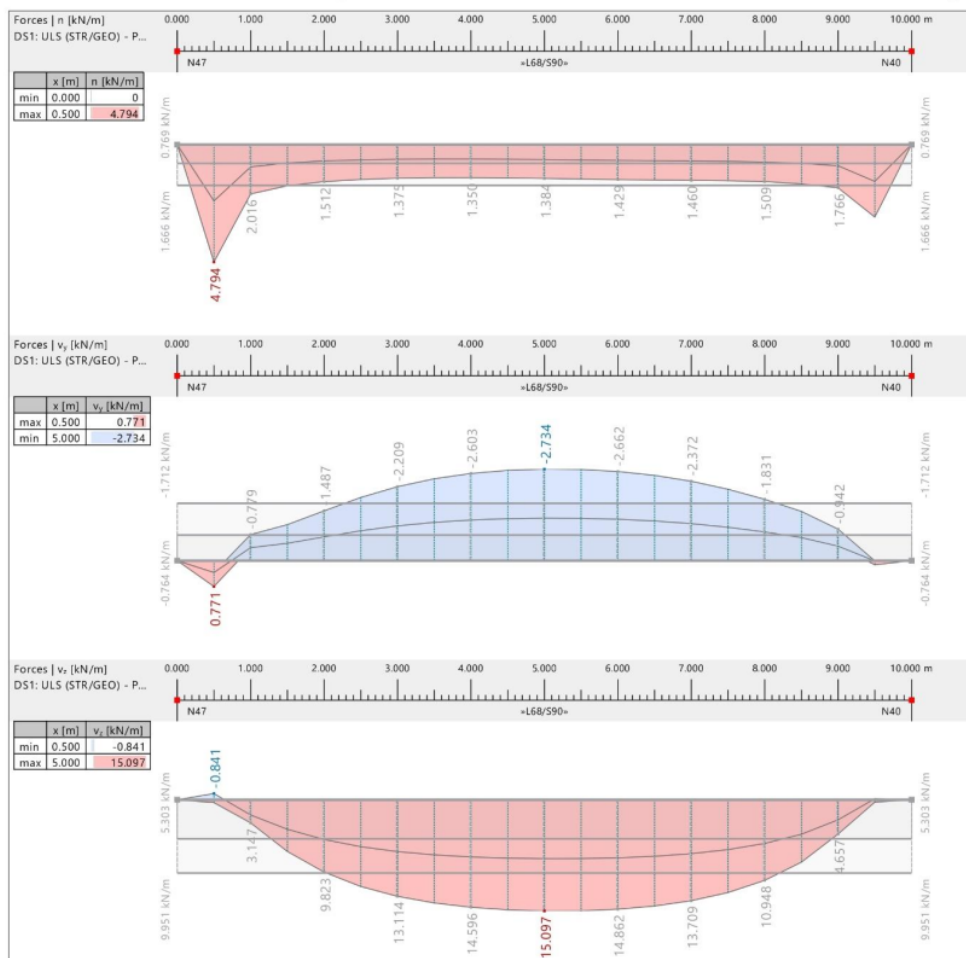

Slika 34. Dijagrami unutarnjih sila na spoju između CLT zida i ploče



Connection

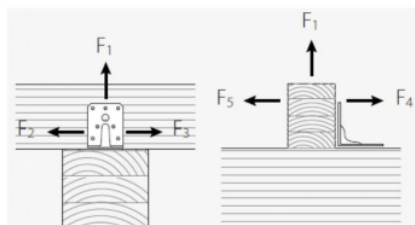

F_1
 F_{23}
 F_{45}
 K_{mod}
Connectors

1.666 kN
1.712 kN
9.951 kN
0.8 -
AG922 / Nail CNA 4,0x50

Design F_1

$F_{k,1} =$	1.7	kN		$R_{k,1,Holz} =$	9.2	kN
				$\gamma_m =$	1.3	-
				$K_{mod} =$	0.80	-
$F_{d,1} =$	1.7	kN	<	$R_{d,1} =$	5.7	kN ✓

Utilization ratio 29%

Design F_{23}

$F_{k,23} =$	1.7	kN		$R_{k,23,Holz} =$	14.7	kN
				$\gamma_m =$	1.3	-
				$K_{mod} =$	0.80	-
$F_{d,23} =$	1.7	kN	<	$R_{d,23} =$	9.0	kN ✓

Utilization ratio 19%

Design F_{45}

$F_{k,45} =$	10.0	kN		$R_{k,45,Holz} =$	22.6	kN
				$\gamma_m =$	1.3	-
				$K_{mod} =$	0.80	-
$F_{d,45} =$	10.0	kN	<	$R_{d,45} =$	13.9	kN ✓

Utilization ratio 72%



Reference documents for this analysis

English title	Description
EN 338	EN 338 - Structural timber ? Strength classes
EN 1995-1-1	EN 1995-1-1 - Eurocode 5: Design of timber structures - Part 1-1: General - Common rules and rules for buildings
EN 1990	EN 1990 - Eurocode ? Basis of structural design
ÖNorm B 1995-1-1 NA	ÖNORM EN 1995-1-1 - Austria - National Annex – Nationally determined parameters – Eurocode 5: Design of timber structures – Part 1-1: General- Common rules and rules for buildings
ÖNorm B 1995-1-2 NA	ÖNORM EN 1995-1-2 - Austria - National Annex - Eurocode 5: Design of timber structures ? Part 1-2: General ? Structural fire design ? National specifications concerning ÖNORM EN 1995-1-2, national comments and national supplements
ETA-11/0030	ETA-11/0030 European Technical Approval; Rothoblaas; Self-tapping screws for use in timber structures
ETA-12/0063	SFS intec AG; Self-tapping screws for use in timber constructions
ETA-12/0062	SFA intec AG; ETA-12/0062; selftapping screws for use in timber constructions
ETA-11/0086	GH Various Angle Brackets
ETA-09/0322	GH Various Angle Brackets
ETA-11/0496	Rotho Blaas TITAN Angle Brackets
ETA-11/0190	selftaping screw by Würth
ETA-12/0373	Schmid - Screws for use in timber constructions
ETA-12/0114	SPAX - Screws for use in timber constructions
ETA-21/0670	Simpson Strong-Tie® Structural screws SWW, SWC, TTUFS, TTSFS and TTZNFS
ETA-13/0796	Simpson Strong-Tie® screws ESCR/ESCR-S, ESCRC/ESCRC-S., ESCRS, ESCRFTC, ESCRFT/FTZ, ESCRHD/HRD, ESCRT2R, SSTA and ESCRH
ETA-20/0773	Würth - DENEb Angle Brackets and plate connectors
ETA-08/0183	Würth - Typ A + Typ V Angle Bracket
ETA-14/0274	Würth - Hold down and storey connector



Disclaimer

The software was created to assist engineers in their daily business. The software is an engineering software that is dealing with a very complex matter of structural analysis and building physics analysis. Therefore, this software shall only be operated by skilled, experienced engineers, with a deep understanding of structural engineering and building physics related to timber structures. The user of the software is obliged to check all input values, no matter if they were given by the user or given by default by the software and all results for plausibility. The use of the results of the software should not be relied upon as the basis for any decision or action. Any use of results of the software is only allowed, if the results have been verified and approved regarding completeness and correctness by a project structural/building physics engineer. The user has the possibility to make print-outs from the software. Any modification of those are not allowed. Stora Enso Wood Products GmbH does not assume any warranty regarding the software. The software has been developed with utmost diligence, nevertheless Stora Enso Wood Products GmbH, neither expressly nor implicitly, provides any warranty in terms of accuracy, validity, timeliness and completeness of information and data created by the software. Stora Enso Wood Products GmbH does also not assume any warranty for the general usability of the software, its suitability for a special purpose or for the compatibility of the software with the ones of third party producers or providers. Stora Enso Wood Products GmbH is only liable for damages caused by gross negligence or intent through Stora Enso Wood Products GmbH; the liability for slight negligence is excluded. This does not apply to personal injury. Under the aforementioned conditions Stora Enso Wood Products GmbH is as well not liable for operational failures or the loss of programs and/or data of the user's data processing system. Applicable Law: These terms of use shall be governed by the laws of Austria excluding however any conflict of laws rules and any laws regarding the Convention of the International Sale of Goods (CISG).

CODES AND DIMENSIONS

TITAN S - TCS | CONCRETE-TD-TIMBER JOINTS

CODE	B [mm] [in]	P [mm] [in]	H [mm] [in]	holes [mm] [in]	$n_v \text{ } \varnothing 11$ $n_v \text{ } \varnothing 0.44$ [pcs]	s [mm] [in]		pcs
TCS240	240 9 1/2	123 4 13/16	130 5 1/8	4 x $\varnothing 17$ 4 x $\varnothing 0.67$	14	3 0.12		10

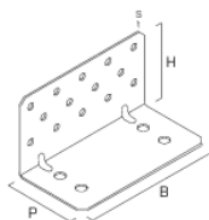

Slika 35. Karakterisike odabranog spojnog sredstva

Odabrano spojno sredstvo TCS240 postavlja se na razmaku od 50 cm.

2.6.4 Spoj zid – ploča – zid

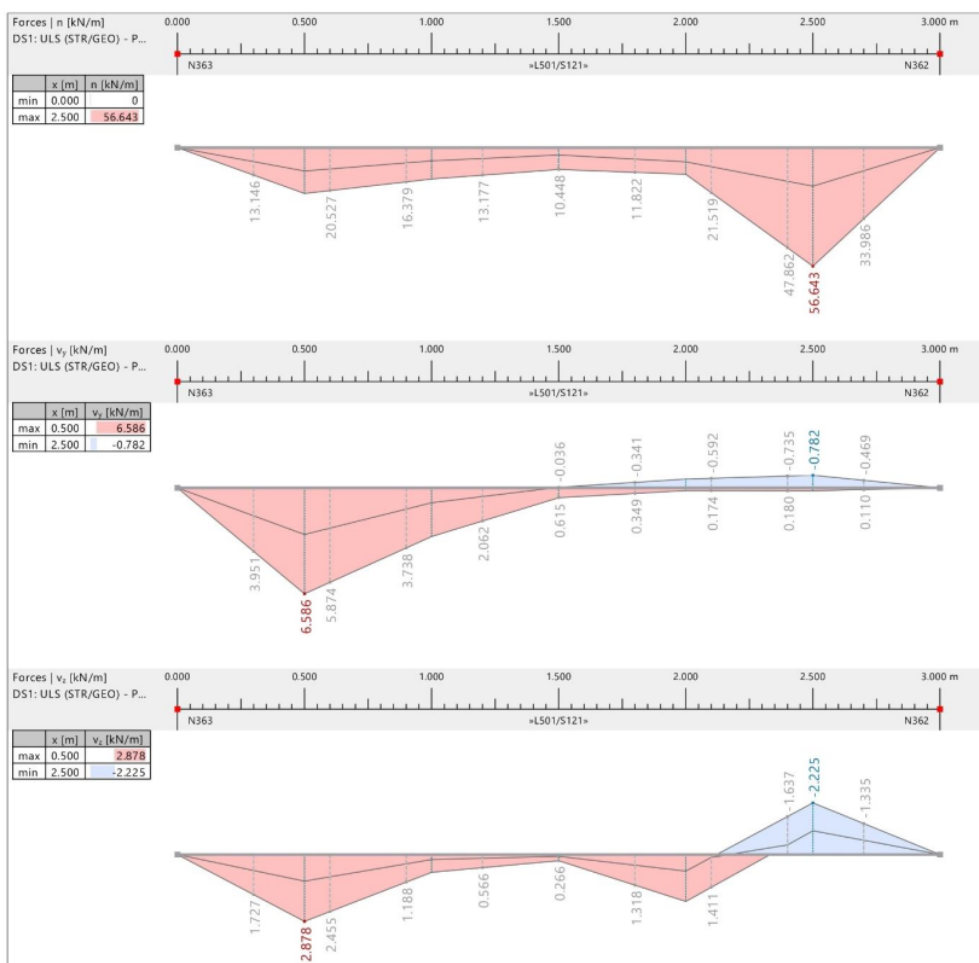

Slika 36. Dijagrami unutarnjih sila na spoju između dva zida i ploče



Connection

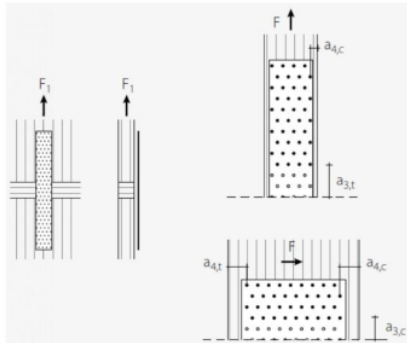

F_1 56.643 kN
 K_{mod} 0.8 -
 Connectors LBV1801200 / Nail 4,0x60 mm
 Space

Design F_1					
$F_{k,1}$ =	56.6	kN	$R_{k,1,Holz}$ =		kN
			γ_m =	1.3	-
			k_{mod} =	0.80	-
$F_{d,1}$ =	56.6	kN	<	$R_{d,1}$ =	64.2 kN ✓
Utilization ratio					88%

Reference documents for this analysis

English title	Description
EN 338	EN 338 - Structural timber ? Strength classes
EN 1995-1-1	EN 1995-1-1 - Eurocode 5: Design of timber structures - Part 1-1: General - Common rules and rules for buildings
EN 1990	EN 1990 - Eurocode ? Basis of structural design
ÖNorm B 1995-1-1 NA	ÖNORM EN 1995-1-1 - Austria - National Annex – Nationally determined parameters – Eurocode 5: Design of timber structures – Part 1-1: General-Common rules and rules for buildings
ÖNorm B 1995-1-2 NA	ÖNORM EN 1995-1-2 - Austria - National Annex - Eurocode 5: Design of timber structures ? Part 1-2: General ? Structural fire design ? National specifications concerning ÖNORM EN 1995-1-2, national comments and national supplements
ETA-11/0030	ETA-11/0030 European Technical Approval; Rothoblaas; Self-tapping screws for use in timber structures
ETA-12/0063	SFS intec AG; Self-tapping screws for use in timber constructions

© 2024 - Calculatis by Stora Enso - Version 7.10.0
 Any use of results of the software is only allowed, if the results have been verified and approved regarding completeness and correctness by a project structural/building physics engineer. For more information see the Terms of Use.



Reference documents for this analysis

English title	Description
ETA-12/0062	SFA intec AG; ETA-12/0062; selftapping screws for use in timber constructions
ETA-11/0086	GH Various Angle Brackets
ETA-09/0322	GH Various Angle Brackets
ETA-11/0496	Rotho Blaas TITAN Angle Brackets
ETA-11/0190	selftaping screw by Würth
ETA-12/0373	Schmid - Screws for use in timber constructions
ETA-12/0114	SPAX - Screws for use in timber constructions
ETA-21/0670	Simpson Strong-Tie® Structural screws SWW, SWC, TTUFS, TTSFS and TTZNFs
ETA-13/0796	Simpson Strong-Tie® screws ESCR/ESCR-S, ESCRC/ESCR-S., ESCRS, ESCRFTC, ESCRFT/FTZ, ESCRHD/HRD, ESCRT2R, SSTA and ESCRH
ETA-20/0773	Würth - DENEb Angle Brackets and plate connectors
ETA-08/0183	Würth - Typ A + Typ V Angle Bracket
ETA-14/0274	Würth - Hold down and storey connector

Disclaimer

The software was created to assist engineers in their daily business. The software is an engineering software that is dealing with a very complex matter of structural analysis and building physics analysis. Therefore, this software shall only be operated by skilled, experienced engineers, with a deep understanding of structural engineering and building physics related to timber structures. The user of the software is obliged to check all input values, no matter if they were given by the user or given by default by the software and all results for plausibility. The use of the results of the software should not be relied upon as the basis for any decision or action. Any use of results of the software is only allowed, if the results have been verified and approved regarding completeness and correctness by a project structural/building physics engineer. The user has the possibility to make print-outs from the software. Any modification of those are not allowed. Stora Enso Wood Products GmbH does not assume any warranty regarding the software. The software has been developed with utmost diligence, nevertheless Stora Enso Wood Products GmbH, neither expressly nor implicitly, provides any warranty in terms of accuracy, validity, timeliness and completeness of information and data created by the software. Stora Enso Wood Products GmbH does also not assume any warranty for the general usability of the software, its suitability for a special purpose or for the compatibility of the software with the ones of third party producers or providers. Stora Enso Wood Products GmbH is only liable for damages caused by gross negligence or intent through Stora Enso Wood Products GmbH; the liability for slight negligence is excluded. This does not apply to personal injury. Under the aforementioned conditions Stora Enso Wood Products GmbH is as well not liable for operational failures or the loss of programs and/or data of the user's data processing system. Applicable Law: These terms of use shall be governed by the laws of Austria excluding however any conflict of laws rules and any laws regarding the Convention of the International Sale of Goods (CISG).

© 2024 - Calculatis by Stora Enso - Version 7.10.0

Any use of results of the software is only allowed, if the results have been verified and approved regarding completeness and correctness by a project structural/building physics engineer. For more information see the Terms of Use.

Dimenzioniranje karakterističnih spojeva

LBV 2,0 x 1200 mm

CODE	B	H	s	B	H	s	n Ø5 n Ø0.20 [pcs]		pcs
	[mm]	[mm]	[mm]	[in]	[in]	[in]			
LBV401200	40	1200	2.0	1 9/16	47 1/4	0.08	90	•	20
LBV601200	60	1200	2.0	2 3/8	47 1/4	0.08	150	•	20
LBV801200	80	1200	2.0	3 1/8	47 1/4	0.08	210	•	20
LBV1001200	100	1200	2.0	4	47 1/4	0.08	270	•	10
LBV1201200	120	1200	2.0	4 3/4	47 1/4	0.08	330	•	10
LBV1401200	140	1200	2.0	5 1/2	47 1/4	0.08	390	•	10
LBV1601200	160	1200	2.0	6 1/4	47 1/4	0.08	450	•	10
LBV1801200	180	1200	2.0	7 1/8	47 1/4	0.08	510	•	10
LBV2001200	200	1200	2.0	8	47 1/4	0.08	570	•	5
LBV2201200	220	1200	2.0	8 5/8	47 1/4	0.08	630	•	5
LBV2401200	240	1200	2.0	9 1/2	47 1/4	0.08	690	•	5
LBV2601200	260	1200	2.0	10 1/4	47 1/4	0.08	750	•	5
LBV2801200	280	1200	2.0	11	47 1/4	0.08	810	•	5
LBV3001200	300	1200	2.0	11 3/4	47 1/4	0.08	870	•	5
LBV4001200	400	1200	2.0	15 3/4	47 1/4	0.08	1170	•	5

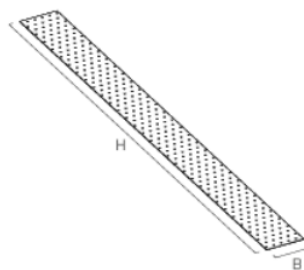

LBA

HIGH BOND NAIL



CODES AND DIMENSIONS

LBA - loose nails

Zn
PLASTER

d ₁ [mm]	CODE	L [mm]	b [mm]	pcs
4	LBA440	40	30	250
	LBA450	50	40	250
	LBA460	60	50	250
	LBA475	75	65	250
	LBA4100	100	85	250
6	LBA660	60	50	250
	LBA680	80	70	250
	LBA6100	100	85	250

Slika 37. Karakteristike odabranog spojnog sredstva LBV iz Rothoblaas kataloga

Odabrano spojno sredstvo postavlja se na razmaku od 50 cm.

2.6.5 Nastavak ploče

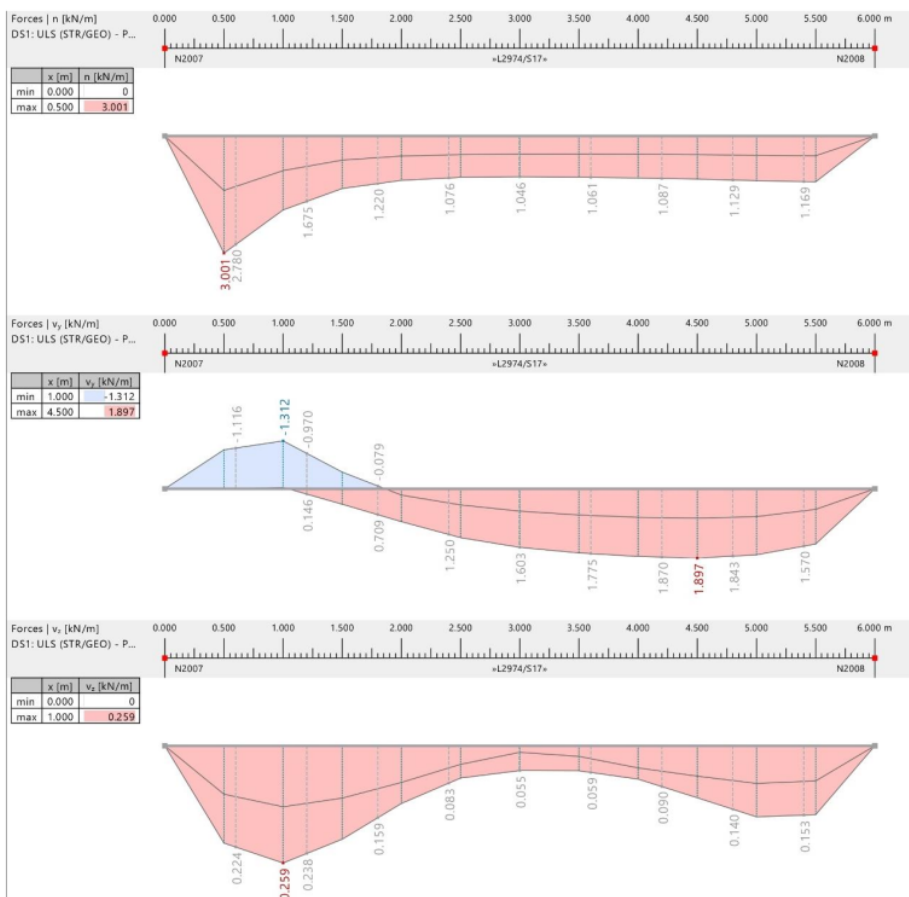

Slika 38. Dijagrami unutarnjih sila na spoju između dvije ploče

VGS

FULLY THREADED SCREW WITH COUNTERSUNK OR HEXAGONAL HEAD

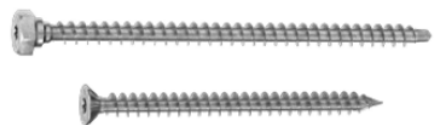

CODES AND DIMENSIONS

d ₁ [mm]	CODE	L [mm]	b [mm]	pcs
	VGS9100	100	90	25
	VGS9120	120	110	25
	VGS9140	140	130	25
	VGS9160	160	150	25
	VGS9180	180	170	25
	VGS9200	200	190	25
	VGS9220	220	210	25
	VGS9240	240	230	25
	VGS9260	260	250	25
	VGS9280	280	270	25
9	VGS9300	300	290	25
TX40	VGS9320	320	310	25

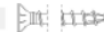

Slika 39. Prikaz spojnog sredstva odabranog iz Rothoblaas kataloga



Connection

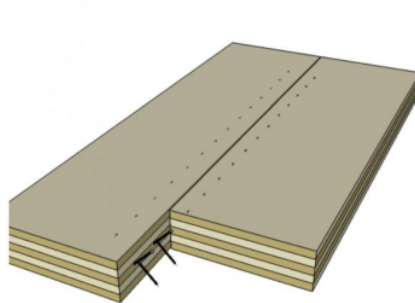

F_x	3.001	kN/m
F_y	1.897	kN/m
F_z	0.259	kN/m
K_{mod}	0.8	-
Material 1	C24 spruce ETA (2022)	
ρ_k	3.85	kN/m ³
Panel 1	CLT 200 L5s	
Orientation cover layer	X direction	
Connector type	Rothoblaas VGS	
Connectors	9/160	
Setup	45° / 135° alternating	
Diameter	9	mm
Head diameter	16	mm
Length	160	mm
Thread length	150	mm
Pre-drilled	✓	

Analysis

Analysis	Existing	Limit	Unit	Utilization
Thickness 1	80	48	mm	60%
Thickness 2	80	48	mm	60%
F_v	1500.5	3308.027	N	45%
F_{ax}	1524.522	4366.833	N	35%
Combination	0.328	1	-	33%
Count	1.145	4.684	Count / lm	24%



Structural system

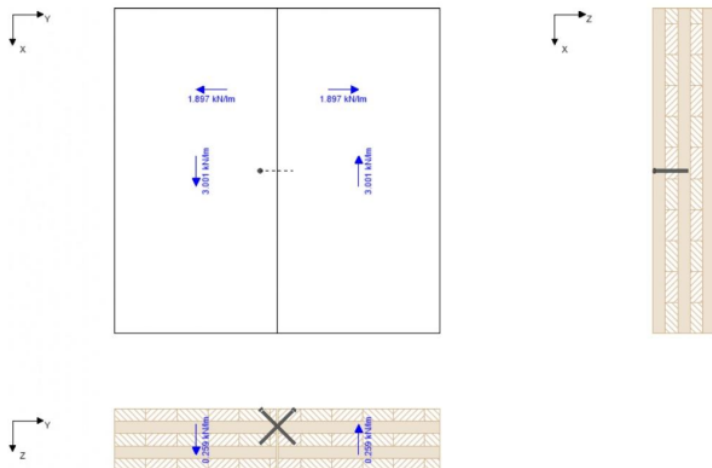

Minimum spacing

Name	$a_{1,min}$ [mm]	$a_{2,min}$ [mm]	$a_{3c,min}$ [mm]	$a_{3t,min}$ [mm]	$a_{4c,min}$ [mm]	$a_{4t,min}$ [mm]
CLT left	45	23	54	54	36	54
CLT right	45	23	54	54	36	54

Result in layers

Element 1							Element 2						
X	Thick	Typ	α	l_{ef}	$l_{ef,y}$	$F_{ax,Rk}$	X	Thick	Typ	α	l_{ef}	$l_{ef,y}$	$F_{ax,Rk}$
[mm]	[mm]		[°]	[mm]	[mm]	[N]	[mm]	[mm]		[°]	[mm]	[mm]	[N]
0	7	L	90	0	0	0	0	40	L	90	0	0	0
7	33	L	90	46.6	32.9	5292	40	20	C	45	0	0	0
40	13	C	45	18.4	13	1904	60	20	C	45	28.1	19.9	2907
53	27	C	45	0	0	0	80	26	L	90	36.9	26.1	4189
80	40	L	90	0	0	0	106	14	L	90	0	0	0
120	40	C	45	0	0	0	120	40	C	45	0	0	0
160	40	L	90	0	0	0	160	40	L	90	0	0	0

© 2024 - Calculatis by Stora Enso - Version 7.10.0
Any use of results of the software is only allowed, if the results have been verified and approved regarding completeness and correctness by a project structural/building physics engineer. For more information see the Terms of Use.



Results

$d_{1,min}$	$d_{2,min}$	$f_{h,k,1}$	$f_{h,k,2}$	β	$t_{pen,1}$	$t_{pen,2}$	$l_{eff,1}$	$l_{eff,2}$	$t_{1,req}$	$t_{2,req}$	$F_{ax,Rk1}$	$F_{ax,Rk2}$
[mm]	[mm]	[N/mm ²]	[N/mm ²]	[-]	[mm]	[mm]	[mm]	[mm]	[mm]	[mm]	[N]	[N]
0	0	20.00	20.00	1.00	80.00	80.00	65.00	65.00	48	48	7196.37	7096.10

Results

$M_{y,Rk}$	$F_{ax,Rk}$	$F_{head,Rk}$	$F_{tens,Rk}$	$F_{k,Rk}$	$F_{v,Rk}$	$F_{v,Rd}$	$F_{v,Ed}$	$F_{ax,Rd}$	$F_{ax,Ed}$	Count	Count _{max}	a_{bet}
[Nmm]	[N]	[N]	[kN]	[kN]	[N]	[N]	[kN/lm]	[N]	[kN/lm]	[Stk/m]	[Stk/m]	[mm]
27244.13	7096.10	0.00	25.400	16.178	5375.54	3308.03	3.00	4366.83	3.05	1.14	4.68	500

Reference documents for this analysis

English title	Description
EN 338	EN 338 - Structural timber ? Strength classes
EN 1995-1-1	EN 1995-1-1 - Eurocode 5: Design of timber structures - Part 1-1: General - Common rules and rules for buildings
EN 1990	EN 1990 - Eurocode ? Basis of structural design
ÖNorm B 1995-1-1 NA	ÖNORM EN 1995-1-1 - Austria - National Annex – Nationally determined parameters – Eurocode 5: Design of timber structures – Part 1-1: General-Common rules and rules for buildings
ÖNorm B 1995-1-2 NA	ÖNORM EN 1995-1-2 - Austria - National Annex - Eurocode 5: Design of timber structures ? Part 1-2: General ? Structural fire design ? National specifications concerning ÖNORM EN 1995-1-2, national comments and national supplements
ETA-11/0030	ETA-11/0030 European Technical Approval; Rothoblaas; Self-tapping screws for use in timber structures
ETA-12/0063	SFS intec AG; Self-tapping screws for use in timber constructions
ETA-12/0062	SFA intec AG; ETA-12/0062; selftapping screws for use in timber constructions
ETA-11/0086	GH Various Angle Brackets
ETA-09/0322	GH Various Angle Brackets
ETA-11/0496	Rotho Blaas TITAN Angle Brackets
ETA-11/0190	selftaping screw by Würth
ETA-12/0373	Schmid - Screws for use in timber constructions
ETA-12/0114	SPAX - Screws for use in timber constructions



Reference documents for this analysis

English title	Description
ETA-21/0670	Simpson Strong-Tie® Structural screws SWW, SWC, TTUFS, TTSFS and TTZNFS
ETA-13/0796	Simpson Strong-Tie® screws ESCR/ESCR-S, ESCRC/ESCR-S., ESCRS, ESCRFTC, ESCRFT/FTZ, ESCRHD/HRD, ESCRT2R, SSTA and ESCRH
ETA-20/0773	Würth - DENEK Angle Brackets and plate connectors
ETA-08/0183	Würth - Typ A + Typ V Angle Bracket
ETA-14/0274	Würth - Hold down and storey connector

Disclaimer

The software was created to assist engineers in their daily business. The software is an engineering software that is dealing with a very complex matter of structural analysis and building physics analysis. Therefore, this software shall only be operated by skilled, experienced engineers, with a deep understanding of structural engineering and building physics related to timber structures. The user of the software is obliged to check all input values, no matter if they were given by the user or given by default by the software and all results for plausibility. The use of the results of the software should not be relied upon as the basis for any decision or action. Any use of results of the software is only allowed, if the results have been verified and approved regarding completeness and correctness by a project structural/building physics engineer. The user has the possibility to make print-outs from the software. Any modification of those are not allowed. Stora Enso Wood Products GmbH does not assume any warranty regarding the software. The software has been developed with utmost diligence, nevertheless Stora Enso Wood Products GmbH, neither expressly nor implicitly, provides any warranty in terms of accuracy, validity, timeliness and completeness of information and data created by the software. Stora Enso Wood Products GmbH does also not assume any warranty for the general usability of the software, its suitability for a special purpose or for the compatibility of the software with the ones of third party producers or providers. Stora Enso Wood Products GmbH is only liable for damages caused by gross negligence or intent through Stora Enso Wood Products GmbH; the liability for slight negligence is excluded. This does not apply to personal injury. Under the aforementioned conditions Stora Enso Wood Products GmbH is as well not liable for operational failures or the loss of programs and/or data of the user's data processing system. Applicable Law: These terms of use shall be governed by the laws of Austria excluding however any conflict of laws rules and any laws regarding the Convention of the International Sale of Goods (CISG).

2.6.6 Spoj CLT ploče i čelične grede

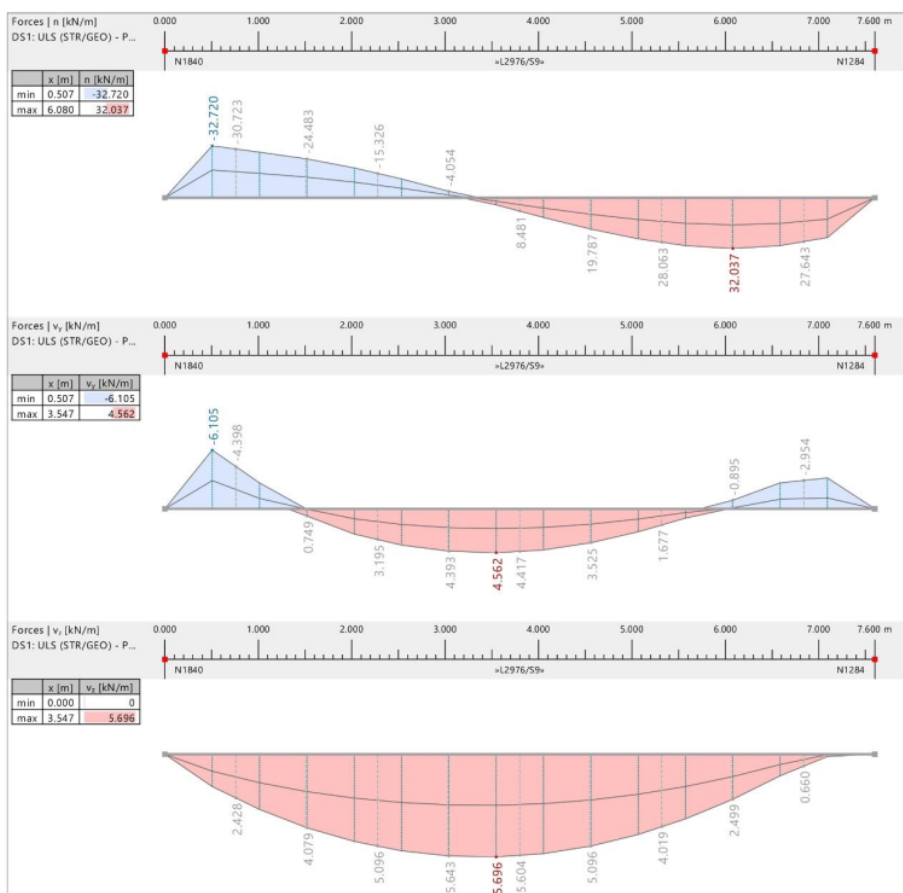

Slika 40. Dijagrami unutarnjih sila na spoju između CLT ploče i čelične grede

HBS PLATE

PAN HEAD SCREW FOR PLATES



CODES AND DIMENSIONS

HBS PLATE

d ₁ [mm]	CODE	L [mm]	b [mm]	A _p [mm]	pcs
8 TX 40	HBSPL860	60	52	1+10	100
	HBSPL880	80	55	1+15	100
	HBSPL8100	100	75	1+15	100
	HBSPL8120	120	95	1+15	100
	HBSPL8140	140	110	1+20	100
	HBSPL8160	160	130	1+20	100

Slika 41. Prikaz spojnog sredstva odabranog iz Rothoblaas kataloga



Connection

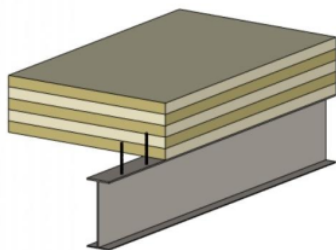

F_x	32.72	kN/lm
F_z	5.7	kN/lm
K_{mod}	0.8	-
Material 1	Steel S355	
ρ_k		kN/m ³
Material 2	C24 spruce ETA (2022)	
ρ_k	3.85	kN/m ³
Panel 2	CLT 160 L5s	
Orientation cover layer	✓	
Connector type	Rothoblaas HBS	
Connectors	8/140	
Diameter	8	mm
Head diameter	14.5	mm
Length	140	mm
Thread length	60	mm
Number of rows	1	
Steel element width	280	mm
Steel element thickness	13	mm

Analysis

Analysis	Existing	Limit	Unit	Utilization
Width 2	280	48	mm	17%
Thickness 2	127	25	mm	20%
F_v	3328.873	3388.37	N	98%
F_x	579.908	3108.183	N	19%
Combination	1	1	-	100%
Count	9.829	31.25	Count / lm	31%



Structural system

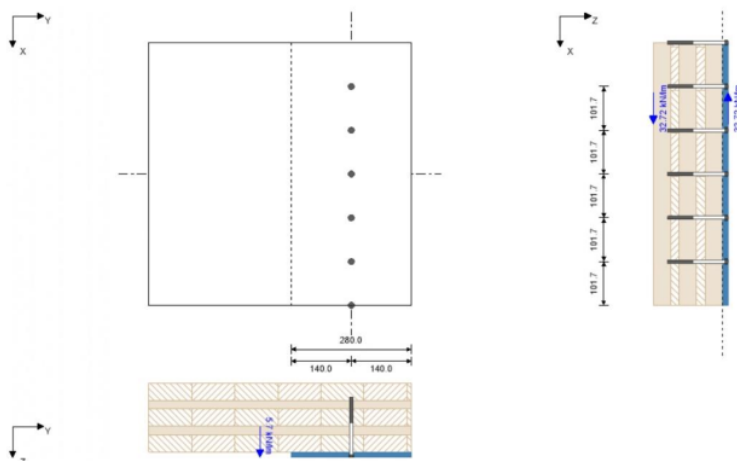

Minimum spacing

Name	$a_{1,min}$ [mm]	$a_{2,min}$ [mm]	$a_{3c,min}$ [mm]	$a_{3t,min}$ [mm]	$a_{4c,min}$ [mm]	$a_{4t,min}$ [mm]
CLT	32	20	48	48	20	48

Result in layers

Element 2

X [mm]	Thick [mm]	Typ	α [°]	l_{eff} [mm]	$l_{eff,v}$ [mm]	$F_{ax,Rk}$ [N]
0	5	L	90	0	0	0
5	35	L	90	35	35	3536
40	15	C	90	15	15	1515
55	5	C	90	0	0	0
60	40	L	90	0	0	0
100	20	C	90	0	0	0
120	40	L	90	0	0	0



Results												
$b_{1,min}$	$b_{2,min}$	$f_{n,k,1}$	$f_{n,k,2}$	β	$t_{pen,1}$	$t_{pen,2}$	$l_{eff,1}$	$l_{eff,2}$	$t_{1,req}$	$t_{2,req}$	$F_{ax,Rk1}$	$F_{ax,Rk2}$
[mm]	[mm]	[N/mm ²]	[N/mm ²]	[-]	[mm]	[mm]	[mm]	[mm]	[mm]	[mm]	[N]	[N]
0	48	0.00	21.21	0.00	13.00	127.00	0.00	50.00	0	25	0.00	5050.80

Results												
$M_{y,Rk}$	$F_{ax,Rk}$	$F_{head,Rk}$	$F_{tens,Rk}$	$F_{kl,Rk}$	$F_{v,Rk}$	$F_{v,Rd}$	$F_{v,Ed}$	$F_{ax,Rd}$	$F_{ax,Ed}$	Count	Count _{max}	a_{ref}
[Nm]	[N]	[N]	[kN]	[kN]	[N]	[N]	[kN/m]	[N]	[kN/m]	[Stk/m]	[Stk/m]	[mm]
20057.48	5050.80	0.00	20.100	0.000	5506.10	3388.37	32.72	3108.18	5.70	9.83	31.25	102

Reference documents for this analysis	
English title	Description
EN 338	EN 338 - Structural timber ? Strength classes
EN 1995-1-1	EN 1995-1-1 - Eurocode 5: Design of timber structures - Part 1-1: General - Common rules and rules for buildings
EN 1990	EN 1990 - Eurocode ? Basis of structural design
ÖNorm B 1995-1-1 NA	ÖNORM EN 1995-1-1 - Austria - National Annex – Nationally determined parameters – Eurocode 5: Design of timber structures – Part 1-1: General-Common rules and rules for buildings
ÖNorm B 1995-1-2 NA	ÖNORM EN 1995-1-2 - Austria - National Annex - Eurocode 5: Design of timber structures ? Part 1-2: General ? Structural fire design ? National specifications concerning ÖNORM EN 1995-1-2, national comments and national supplements
ETA-11/0030	ETA-11/0030 European Technical Approval; Rothoblaas; Self-tapping screws for use in timber structures
ETA-12/0063	SFS intec AG; Self-tapping screws for use in timber constructions
ETA-12/0062	SFA intec AG; ETA-12/0062; selftapping screws for use in timber constructions
ETA-11/0086	GH Various Angle Brackets
ETA-09/0322	GH Various Angle Brackets
ETA-11/0496	Rotho Blaas TITAN Angle Brackets
ETA-11/0190	selftaping screw by Würth
ETA-12/0373	Schmid - Screws for use in timber constructions
ETA-12/0114	SPAX - Screws for use in timber constructions

© 2024 - Calculats by Stora Enso - Version 7.10.0
Any use of results of the software is only allowed, if the results have been verified and approved regarding completeness and correctness by a project structural/building physics engineer. For more information see the Terms of Use.



Reference documents for this analysis

English title	Description
ETA-21/0670	Simpson Strong-Tie® Structural screws SWW, SWC, TTUFS, TTSFS and TTZNFS
ETA-13/0796	Simpson Strong-Tie® screws ESCR/ESCR-S, ESCRC/ESCR-C-S, ESCRS, ESCRFTC, ESCRFT/FTZ, ESCRHD/HRD, ESCRT2R, SSTA and ESCRH
ETA-20/0773	Würth - DENEK Angle Brackets and plate connectors
ETA-08/0183	Würth - Typ A + Typ V Angle Bracket
ETA-14/0274	Würth - Hold down and storey connector

Disclaimer

The software was created to assist engineers in their daily business. The software is an engineering software that is dealing with a very complex matter of structural analysis and building physics analysis. Therefore, this software shall only be operated by skilled, experienced engineers, with a deep understanding of structural engineering and building physics related to timber structures. The user of the software is obliged to check all input values, no matter if they were given by the user or given by default by the software and all results for plausibility. The use of the results of the software should not be relied upon as the basis for any decision or action. Any use of results of the software is only allowed, if the results have been verified and approved regarding completeness and correctness by a project structural/building physics engineer. The user has the possibility to make print-outs from the software. Any modification of those are not allowed. Stora Enso Wood Products GmbH does not assume any warranty regarding the software. The software has been developed with utmost diligence, nevertheless Stora Enso Wood Products GmbH, neither expressly nor implicitly, provides any warranty in terms of accuracy, validity, timeliness and completeness of information and data created by the software. Stora Enso Wood Products GmbH does also not assume any warranty for the general usability of the software, its suitability for a special purpose or for the compatibility of the software with the ones of third party producers or providers. Stora Enso Wood Products GmbH is only liable for damages caused by gross negligence or intent through Stora Enso Wood Products GmbH; the liability for slight negligence is excluded. This does not apply to personal injury. Under the aforementioned conditions Stora Enso Wood Products GmbH is as well not liable for operational failures or the loss of programs and/or data of the user's data processing system. Applicable Law: These terms of use shall be governed by the laws of Austria excluding however any conflict of laws rules and any laws regarding the Convention of the International Sale of Goods (CISG).

2.7 Iskaz materijala

Tablica 1. Količine AB površina za zgradu A

Thickness Name	Surfaces No.	Q [--]	S [m ²]	V [m ³]	M [kg/m ²]	M [t]	S Σ [m ²]	V Σ [m ³]	M Σ [t]
Uniform d: 200.0 mm 4 - C35/45	158	1.00	107.081	21.416	500.00	53.541	107.081	21.416	53.541
Uniform d: 200.0 mm 4 - C35/45	115	1.00	90.120	18.024	500.00	45.060	90.120	18.024	45.060
Uniform d: 200.0 mm 4 - C35/45	305	1.00	87.801	17.560	500.00	43.901	87.801	17.560	43.901
Uniform d: 200.0 mm 4 - C35/45	207,215, 224, 232	4.00	60.000	12.000	500.00	30.000	239.999	48.000	120.000
Uniform d: 200.0 mm 4 - C35/45	274	1.00	48.600	9.720	500.00	24.300	48.600	9.720	24.300
Uniform d: 200.0 mm 4 - C35/45	153	1.00	29.040	5.808	500.00	14.520	29.040	5.808	14.520
Uniform d: 200.0 mm 4 - C35/45	143-152	10.00	26.400	5.280	500.00	13.200	263.999	52.800	132.000
Uniform d: 200.0 mm 4 - C35/45	203	1.00	14.850	2.970	500.00	7.425	14.850	2.970	7.425
Uniform d: 200.0 mm 4 - C35/45	193-202	10.00	13.500	2.700	500.00	6.750	135.000	27.000	67.500
Uniform d: 200.0 mm 4 - C35/45	119	1.00	8.400	1.680	500.00	4.200	8.400	1.680	4.200
Uniform d: 200.0 mm 4 - C35/45	42	1.00	7.920	1.584	500.00	3.960	7.920	1.584	3.960
Uniform d: 200.0 mm 4 - C35/45	32-41	10.00	7.200	1.440	500.00	3.600	72.000	14.400	36.000
Uniform d: 200.0 mm 4 - C35/45	69	1.00	4.950	0.990	500.00	2.475	4.950	0.990	2.475
Uniform d: 200.0 mm 4 - C35/45	59-68	10.00	4.500	0.900	500.00	2.250	45.000	9.000	22.500
Uniform d: 200.0 mm 4 - C35/45	285,296	2.00	3.960	0.792	500.00	1.980	7.920	1.584	3.960
Uniform d: 200.0 mm 4 - C35/45	275- 284,286-295	20.00	3.600	0.720	500.00	1.800	72.000	14.400	36.000
Σ		75.00					1234.680	246.936	617.340

Tablica 2. Količine CLT ploča d=200 mm za međukatne i krovne konstrukcije zgrade A

Thickness Name	Surfaces No.	Q [--]	S [m ²]	V [m ³]	M [kg/m ²]	M [t]	S Σ [m ²]	V Σ [m ³]	M Σ [t]
Layers d: 200.0 mm CLT 200 L5s	154-157	4.00	107.081	21.416	84.00	8.995	428.324	85.665	35.979
Layers d: 200.0 mm CLT 200 L5s	303, 304	2.00	87.801	17.560	84.00	7.375	175.603	35.121	14.751
Layers d: 200.0 mm CLT 200 L5s	186-192	7.00	84.107	16.821	84.00	7.065	588.750	117.750	49.455
Layers d: 200.0 mm CLT 200 L5s	175-180	6.00	80.461	16.092	84.00	6.759	482.764	96.553	40.552

Iskaz materijala

Layers d : 200.0 mm CLT 200 L5s	97-99	3.00	75.720	15.144	84.00	6.360	227.159	45.432	19.081
Layers d : 200.0 mm CLT 200 L5s	185	1.00	73.741	14.748	84.00	6.194	73.741	14.748	6.194
Layers d : 200.0 mm CLT 200 L5s	181-184	4.00	70.800	14.160	84.00	5.947	283.199	56.640	23.789
Layers d : 200.0 mm CLT 200 L5s	298-302	5.00	63.435	12.687	84.00	5.329	317.175	63.435	26.643
Layers d : 200.0 mm CLT 200 L5s	204-206,212- 214,221, 222,229,230	10.00	60.000	12.000	84.00	5.040	599.998	120.000	50.400
Layers d : 200.0 mm CLT 200 L5s	267-269	3.00	51.802	10.360	84.00	4.351	155.405	31.081	13.054
Layers d : 200.0 mm CLT 200 L5s	270-273	4.00	48.600	9.720	84.00	4.082	194.399	38.880	16.330
Layers d : 200.0 mm CLT 200 L5s	171-174	4.00	44.437	8.887	84.00	3.733	177.749	35.550	14.931
Layers d : 200.0 mm CLT 200 L5s	15,18	2.00	39.000	7.800	84.00	3.276	78.000	15.600	6.552
Layers d : 200.0 mm CLT 200 L5s	12	1.00	33.344	6.669	84.00	2.801	33.344	6.669	2.801
Layers d : 200.0 mm CLT 200 L5s	11	1.00	30.091	6.018	84.00	2.528	30.091	6.018	2.528
Layers d : 200.0 mm CLT 200 L5s	116	1.00	25.800	5.160	84.00	2.167	25.800	5.160	2.167
Layers d : 200.0 mm CLT 200 L5s	20	1.00	22.974	4.595	84.00	1.930	22.974	4.595	1.930
Layers d : 200.0 mm CLT 200 L5s	16,17	2.00	21.000	4.200	84.00	1.764	42.000	8.400	3.528
Layers d : 200.0 mm CLT 200 L5s	71,73,75,77	4.00	10.800	2.160	84.00	0.907	43.200	8.640	3.629
Layers d : 200.0 mm CLT 200 L5s	408-410,413- 415,418-420, 423-425	12.00	9.000	1.800	84.00	0.756	108.000	21.600	9.072
Layers d : 200.0 mm CLT 200 L5s	118,526	2.00	6.720	1.344	84.00	0.564	13.440	2.688	1.129
Layers d : 200.0 mm CLT 200 L5s	343	1.00	0.659	0.132	84.00	0.055	0.659	0.132	0.055
Σ		80					4101.772	820.354	344.549

Tablica 3. Količine CLT ploča d=140 mm za zidove zgrade A

Thickness Name	Surfaces No.	Q [--]	S [m ²]	V [m ³]	M [kg/m ²]	M [t]	S Σ [m ²]	V Σ [m ³]	M Σ [t]
Layers d : 140.0 mm CLT 140 L5s	211,220,228	3.00	33.000	4.620	58.80	1.940	99.000	13.860	5.821
Layers d : 140.0 mm CLT 140 L5s	208-210,216- 219, 225-227, 233-236	14.00	30.000	4.200	58.80	1.764	419.999	58.800	24.696
Layers d : 140.0 mm CLT 140 L5s	125	1.00	27.964	3.915	58.80	1.644	27.964	3.915	1.644
Layers d : 140.0 mm CLT 140 L5s	257,258	2.00	27.800	3.892	58.80	1.635	55.600	7.784	3.269
Layers d : 140.0 mm CLT 140 L5s	266	1.00	24.750	3.465	58.80	1.455	24.750	3.465	1.455
Layers d : 140.0 mm CLT 140 L5s	126-129	4.00	23.522	3.293	58.80	1.383	94.087	13.172	5.532
Layers d : 140.0 mm CLT 140 L5s	262-265	4.00	22.500	3.150	58.80	1.323	90.000	12.600	5.292
Layers d : 140.0 mm CLT 140 L5s	142	1.00	19.800	2.772	58.80	1.164	19.800	2.772	1.164
Layers d : 140.0 mm CLT 140 L5s	159-164	6.00	18.838	2.637	58.80	1.108	113.026	15.824	6.646
Layers d : 140.0 mm CLT 140 L5s	10	1.00	17.851	2.499	58.80	1.050	17.851	2.499	1.050
Layers d : 140.0 mm CLT 140 L5s	6-9	4.00	16.228	2.272	58.80	0.954	64.914	9.088	3.817
Layers d : 140.0 mm CLT 140 L5s	104,112	2.00	15.300	2.142	58.80	0.900	30.600	4.284	1.799
Layers d : 140.0 mm CLT 140 L5s	14	1.00	13.938	1.951	58.80	0.820	13.938	1.951	0.820
Layers d : 140.0 mm CLT 140 L5s	366-375	10.00	13.861	1.941	58.80	0.815	138.615	19.406	8.151
Layers d : 140.0 mm CLT 140 L5s	13	1.00	13.760	1.926	58.80	0.809	13.760	1.926	0.809
Layers d : 140.0 mm CLT 140 L5s	165-170	6.00	13.300	1.862	58.80	0.782	79.800	11.172	4.692
Layers d : 140.0 mm CLT 140 L5s	26-30,43-53	16.00	13.200	1.848	58.80	0.776	211.199	29.568	12.419
Layers d : 140.0 mm CLT 140 L5s	100-102,106- 110, 113,114,139-141	13.00	13.100	1.834	58.80	0.770	170.300	23.842	10.014
Layers d : 140.0 mm CLT 140 L5s	383-386	4.00	12.800	1.792	58.80	0.753	51.200	7.168	3.011

Iskaz materijala

Layers d : 140.0 mm CLT 140 L5s	25	1.00	11.550	1.617	58.80	0.679	11.550	1.617	0.679
Layers d : 140.0 mm CLT 140 L5s	396,405	2.00	10.850	1.519	58.80	0.638	21.700	3.038	1.276
Layers d : 140.0 mm CLT 140 L5s	21-24	4.00	10.500	1.470	58.80	0.617	42.000	5.880	2.470
Layers d : 140.0 mm CLT 140 L5s	325	1.00	9.900	1.386	58.80	0.582	9.900	1.386	0.582
Layers d : 140.0 mm CLT 140 L5s	103,111,117, 391,395,401	6.00	9.800	1.372	58.80	0.576	58.800	8.232	3.457
Layers d : 140.0 mm CLT 140 L5s	31,387-390, 392-394, 397- 400,402-404	15.00	9.200	1.288	58.80	0.541	138.000	19.320	8.114
Layers d : 140.0 mm CLT 140 L5s	315-324	10.00	9.000	1.260	58.80	0.529	90.000	12.600	5.292
Layers d : 140.0 mm CLT 140 L5s	376-381	6.00	8.300	1.162	58.80	0.488	49.800	6.972	2.928
Layers d : 140.0 mm CLT 140 L5s	124	1.00	8.250	1.155	58.80	0.485	8.250	1.155	0.485
Layers d : 140.0 mm CLT 140 L5s	120-123	4.00	7.500	1.050	58.80	0.441	30.000	4.200	1.764
Layers d : 140.0 mm CLT 140 L5s	70,72,74,76,78	5.00	5.400	0.756	58.80	0.318	27.000	3.780	1.588
Layers d : 140.0 mm CLT 140 L5s	5	1.00	4.955	0.694	58.80	0.291	4.955	0.694	0.291
Layers d : 140.0 mm CLT 140 L5s	1-4	4.00	4.505	0.631	58.80	0.265	18.020	2.523	1.060
Layers d : 140.0 mm CLT 140 L5s	406,407,411, 412,416,417, 421,422,426,427	10.00	4.500	0.630	58.80	0.265	45.000	6.300	2.646
Layers d : 140.0 mm CLT 140 L5s	336,358	2.00	4.132	0.578	58.80	0.243	8.264	1.157	0.486
Layers d : 140.0 mm CLT 140 L5s	326-335,348- 357	20.00	3.756	0.526	58.80	0.221	75.125	10.518	4.417
Layers d : 140.0 mm CLT 140 L5s	337-342,359- 364	12.00	3.444	0.482	58.80	0.203	41.330	5.786	2.430
Σ		198.00					2416.092	338.253	142.066

Tablica 4. Količine stupova GL32h za zgradu A

Section Name	Members No.	Q [--]	L [m]	Am [m ² /m]	V [m ³]	M [kg/m]	M [t]	LΣ [m]	Am, Σ [m ²]	VΣ [m ³]	MΣ [t]
200/200 GL32h	1,2	2.00	3.300	0.800	0.132	19.6	0.065	6.600	5.440	0.264	0.129
Σ		2.00						6.600	5.440	0.264	0.129

Tablica 5. Količine AB površina za zgradu B

Thickness Name	Surfaces No.	Q [--]	S [m ²]	V [m ³]	M [kg/m ²]	M [t]	S Σ [m ²]	V Σ [m ³]	M Σ [t]
Uniform d: 200.0 mm 4 - C35/45	455	1.00	70.200	14.040	500.00	35.100	70.200	14.040	35.100
Uniform d: 200.0 mm 4 - C35/45	495	1.00	68.400	13.680	500.00	34.200	68.400	13.680	34.200
Uniform d: 200.0 mm 4 - C35/45	92,250,450	3.00	60.000	12.000	500.00	30.000	179.999	36.000	90.000
Uniform d: 200.0 mm 4 - C35/45	347	1.00	40.500	8.100	500.00	20.250	40.500	8.100	20.250
Uniform d: 200.0 mm 4 - C35/45	501	1.00	29.700	5.940	500.00	14.850	29.700	5.940	14.850
Uniform d: 200.0 mm 4 - C35/45	496-500	5.00	27.000	5.400	500.00	13.500	135.000	27.000	67.500
Uniform d: 200.0 mm 4 - C35/45	512	1.00	14.850	2.970	500.00	7.425	14.850	2.970	7.425
Uniform d: 200.0 mm 4 - C35/45	507-511	5.00	13.500	2.700	500.00	6.750	67.500	13.500	33.750
Uniform d: 200.0 mm 4 - C35/45	524	1.00	7.920	1.584	500.00	3.960	7.920	1.584	3.960
Uniform d: 200.0 mm 4 - C35/45	519-523	5.00	7.200	1.440	500.00	3.600	36.000	7.200	18.000
Uniform d: 200.0 mm 4 - C35/45	469,482	2.00	4.950	0.990	500.00	2.475	9.900	1.980	4.950
Uniform d: 200.0 mm 4 - C35/45	464-468, 477-481	10.00	4.500	0.900	500.00	2.250	45.000	9.000	22.500
Σ		36.00					704.968	140.994	352.484

Tablica 6. Količine CLT ploča d=200 mm za međukatne i krovne konstrukcije zgrade B

Thickness Name	Surfaces No.	Q [--]	S [m ²]	V [m ³]	M [kg/m ²]	M [t]	S Σ [m ²]	V Σ [m ³]	M Σ [t]
Layers d: 200.0 mm CLT 200 L5s	93,251,451	3.00	70.800	14.160	84.00	5.947	212.399	42.480	17.842
Layers d: 200.0 mm CLT 200 L5s	88-91,246- 249,446-449	12.00	60.000	12.000	84.00	5.040	719.997	143.999	60.480
Layers d: 200.0 mm CLT 200 L5s	429-432	4.00	57.150	11.430	84.00	4.801	228.599	45.720	19.202
Layers d: 200.0 mm CLT 200 L5s	54,261,428	3.00	44.437	8.887	84.00	3.733	133.312	26.662	11.198
Layers d: 200.0 mm CLT 200 L5s	344-346	3.00	40.500	8.100	84.00	3.402	121.500	24.300	10.206
Layers d: 200.0 mm CLT 200 L5s	483,484	2.00	24.750	4.950	84.00	2.079	49.500	9.900	4.158
Layers d: 200.0 mm CLT 200 L5s	485-487	3.00	13.500	2.700	84.00	1.134	40.500	8.100	3.402
Layers d: 200.0 mm CLT 200 L5s	95,255,453	3.00	10.800	2.160	84.00	0.907	32.400	6.480	2.722
Layers d: 200.0 mm CLT 200 L5s	79-81,237- 239,437-439	9.00	9.000	1.800	84.00	0.756	81.000	16.200	6.804
Σ		42.00					1619.21	323.84	136.01

Tablica 7. Količine CLT ploča d=160 mm za međukatne i krovne konstrukcije zgrade B

Thickness Name	Surfaces No.	Q [--]	S [m ²]	V [m ³]	M [kg/m ²]	M [t]	S Σ [m ²]	V Σ [m ³]	M Σ [t]
Layers d : 160.0 mm CLT 160 L5s	489-492,494	5.00	68.400	10.944	67.20	4.596	341.999	54.720	22.982
Layers d : 160.0 mm CLT 160 L5s	9	1.00	34.201	5.472	67.20	2.298	34.201	5.472	2.298
Layers d : 160.0 mm CLT 160 L5s	7	1.00	34.199	5.472	67.20	2.298	34.199	5.472	2.298
Σ		7.00					410.40	65.66	27.58

V

Tablica 8. Količine CLT ploča d=140 mm za zidove zgrade B

Thickness Name	Surfaces No.	Q [--]	S [m ²]	V [m ³]	M [kg/m ²]	M [t]	S Σ [m ²]	V Σ [m ³]	M Σ [t]
Layers d : 140.0 mm CLT 140 L5s	18,137,313	3.00	33.000	4.620	58.80	1.940	99.000	13.860	5.821
Layers d : 140.0 mm CLT 140 L5s	13-16,134-136, 308-311,528,531	13.00	30.000	4.200	58.80	1.764	389.999	54.600	22.932
Layers d : 140.0 mm CLT 140 L5s	17,132	2.00	27.800	3.892	58.80	1.635	55.600	7.784	3.269
Layers d : 140.0 mm CLT 140 L5s	463	1.00	25.080	3.511	58.80	1.475	25.080	3.511	1.475
Layers d : 140.0 mm CLT 140 L5s	458-461,529	5.00	22.800	3.192	58.80	1.341	114.000	15.960	6.703
Layers d : 140.0 mm CLT 140 L5s	518	1.00	21.080	2.951	58.80	1.240	21.080	2.951	1.240
Layers d : 140.0 mm CLT 140 L5s	513-516,525	5.00	18.800	2.632	58.80	1.105	94.000	13.160	5.527
Layers d : 140.0 mm CLT 140 L5s	4	1.00	15.950	2.233	58.80	0.938	15.950	2.233	0.938
Layers d : 140.0 mm CLT 140 L5s	252,253	2.00	15.300	2.142	58.80	0.900	30.600	4.284	1.799
Layers d : 140.0 mm CLT 140 L5s	502-506	5.00	14.900	2.086	58.80	0.876	74.500	10.430	4.381
Layers d : 140.0 mm CLT 140 L5s	96,256,454	3.00	13.200	1.848	58.80	0.776	39.600	5.544	2.328
Layers d : 140.0 mm CLT 140 L5s	55-58,259, 260,433-436	10.00	13.100	1.834	58.80	0.770	131.000	18.340	7.703
Layers d : 140.0 mm CLT 140 L5s	1-3,5,6,8	6.00	9.800	1.372	58.80	0.576	58.800	8.232	3.457
Layers d : 140.0 mm CLT 140 L5s	82-86,240- 244,440-444	15.00	9.200	1.288	58.80	0.541	137.999	19.320	8.114
Layers d : 140.0 mm CLT 140 L5s	19,138, 314,476	4.00	5.400	0.756	58.80	0.318	21.600	3.024	1.270
Layers d : 140.0 mm CLT 140 L5s	11,12,130,131, 306,307,456,457	8.00	4.500	0.630	58.80	0.265	36.000	5.040	2.117
Layers d : 140.0 mm CLT 140 L5s	475	1.00	2.970	0.416	58.80	0.175	2.970	0.416	0.175
Layers d : 140.0 mm CLT 140 L5s	470-473,530	5.00	2.700	0.378	58.80	0.159	13.500	1.890	0.794
Σ		90.00					1361.28	190.58	80.04

Tablica 9. Količine greda HE280A za zgradu B

Section Name	Members No.	Q [--]	L [m]	Am [m ² /m]	V [m ³]	M [kg/m]	M [t]	L Σ [m]	Am, Σ [m ²]	V Σ [m ³]	M Σ [t]
HE 280 A S355	3-8	6.00	7.600	1.603	0.074	76.4	0.580	45.600	73.201	0.444	3.483
Σ		6.00						45.600	73.201	0.444	3.483

3 ZAKLJUČAK

U posljednje vrijeme, drvo je postalo ključni materijal u modernoj gradnji, osobito u izgradnji višekatnih zgrada i hibridnih sustava koji kombiniraju drvo s betonom i čelikom. Materijali na bazi drva, na primjer CLT i LLD imaju sve veću primjenu, kako samostalnu, tako i zajedničku radi maksimalne iskoristivosti njihovih prednosti.

Ovaj trend reflektira rastuću potražnju za održivim građevinskim rješenjima koja smanjuju emisiju CO₂ i omogućuju brzu gradnju. Kombinacija drva s tradicionalnim materijalima poput betona i čelika pruža stabilnost i prilagodljivost, osobito u seizmičkim područjima.

U ovom diplomskom radu analizirana je drvena konstrukcija visoke zgrade s betonskom jezgrom i podrumom, koja je prošla sve provjere graničnih stanja nosivosti i uporabivosti. Projekt mi je omogućio bolje razumijevanje prednosti i potencijala drvenih konstrukcija. Drvo nudi održivost, brzu gradnju i estetsku vrijednost, a istraživanje novih materijala ključno je za budućnost građevinarstva.

Iako CLT u Hrvatskoj još uvijek nije široko zastupljen, ova zgrada predstavlja primjer gradnje koji bi mogao postati sve češći u budućnosti. Rastuća svijest o prednostima ovog materijala ukazuje na to da će se CLT sve više primjenjivati u različitim vrstama objekata. S porastom potražnje za održivim rješenjima, očekuje se da će ovakvi projekti, koji kombiniraju inovativnost i funkcionalnost, postati standard u suvremenoj arhitekturi i graditeljstvu u Hrvatskoj.

Zaključno, drvo u kombinaciji s naprednim tehnologijama nudi inovativna, održiva rješenja koja mogu unaprijediti građevinske metode i doprinijeti ekološki prihvatljivijoj budućnosti građevinske industrije.

POPIS LITERATURE

- [1] Jeleč, M., Varevac, D., Rajčić, V.: Križno lamelirano drvo (CLT) – pregled stanja područja, *GRAĐEVINAR*, 70 (2018) 2, pp. 75-95: <https://hrcak.srce.hr/clanak/291371%3F>
- [2] Bjelinović, A., Rajčić V.: Drvene konstrukcije prema europskim normama, Hrvatska Sveučilišna naklada: Građevinski fakultet Sveučilišta u Zagrebu, Zagreb, 2005.
- [3] <https://climate.mit.edu/ask-mit/how-does-climate-impact-cross-laminated-timber-compare-steel-or-concrete>
- [4] <https://projects.research-and-innovation.ec.europa.eu/en/horizon-magazine/they-can-capture-more-carbon-they-emit-so-why-arent-wooden-buildings-mainstream>
- [5] Brandner, R., Flatscher, G., Ringhofer, A., Schickhofer, G., & Thiel, A. (2016). Cross laminated timber (CLT): overview and development. *European Journal of Wood and Wood Products*, 74 (3). <https://doi.org/10.1007/s00107-015-0999-5>
- [6] <https://www.dlubal.com/en/solutions/online-services/snow-load-wind-speed-and-seismic-load-maps>
- [7] Plates and connectors for timber, Rothoblaas

POPIS SLIKA

Slika 1. Slaganje lamela unutar jednog panela.....	1
Slika 2. Geometrijske karakteristike CLT elemenata za djelovanje okomito na ravninu (lijevo) i djelovanje u ravnini (desno)	2
Slika 3. Postupak proizvodnje CLT panela.....	3
Slika 4. Pregled emisije ugljikovog dioksida za zgrade od različitih materijala	4
Slika 5. Shematski prikaz gradnje s CLT panelima	5
Slika 6. Shematski prikaz gradnje sa LLD stupovima i gredama.....	6
Slika 7. Mjøstårnet, Norveška	7
Slika 8. Brock Commons Tallwood House, Vancouver, Kanada.....	7
Slika 9. Ascent, SAD	8
Slika 10. 55 Southbank Boulevard, Melbourne, Australia.....	8
Slika 11. Situacija.....	9
Slika 12. Mikrolokacija postojećeg bloka.....	9
Slika 13. Pogled na zgradu - sjeverozapad Slika 14. Pogled na zgradu - sjeveroistok	10
Slika 15. Pogled na zgradu - sjeveroistok.....	10
Slika 16. Prikaz modela zgrade – Dlubal RFEM	12
Slika 17. Karakteristična vrijednost opterećenja snijegom na tlo za lokaciju Zagreb	13
Slika 18. Osnovna brzina vjetra za lokaciju Zagreb	14
Slika 19. Koeficijent izloženosti	15
Slika 20. Koeficijenti vanjskog tlaka za vertikalne zidove građevina pravokutnog tlocrta..	16
Slika 21. Koeficijenti vanjskog tlaka za ravne krovove	16
Slika 22. Koeficijenti vanjskog tlaka za zidove i ravne krovove za zgradu A – Slučaj 1 i 2... 18	18
Slika 23. Koeficijenti vanjskog tlaka za zidove i ravne krovove za zgradu A – Slučaj 3 i 4... 19	19
Slika 24. Koeficijenti vanjskog tlaka za zidove i ravne krovove za zgradu B – Slučaj 1 i 2... 21	21
Slika 25. Koeficijenti vanjskog tlaka za zidove i ravne krovove za zgradu A – Slučaj 3 i 4... 22	22
Slika 26. Prikaz povratnih perioda i ubrzanja tla za Zagreb	24
Slika 27. Dijagrami unutarnjih sila na spoju između CLT zida i betonske ploče	171
Slika 28. Karakteristike odabranog spojnog sredstva TCS240 iz Rothoblaas kataloga	175
Slika 29. Karakteristike odabranog spojnog sredstva WHT20 iz Rothoblaas kataloga ...	176
Slika 30. Karakteristike odabranog spojnog sredstva WHT20 iz Rothoblaas kataloga	177
Slika 31. Dijagrami unutarnjih sila na spoju između zidova	178
Slika 32. Prikaz izvedenog spoja zidova i ploča od CLT-a sa spojnim sredstvom TCS240	182
Slika 33. Karakteristike odabranog spojnog sredstva	182

Slika 34. Dijagrami unutarnjih sila na spoju između CLT zida i ploče.....	183
Slika 35. Karakteristike odabranog spojnog sredstva.....	186
Slika 36. Dijagrami unutarnjih sila na spoju između dva zida i ploče.....	187
Slika 37. Karakteristike odabranog spojnog sredstva LBV iz Rothoblaas kataloga	190
Slika 38. Dijagrami unutarnjih sila na spoju između dvije ploče	191
Slika 39. Prikaz spojnog sredstva odabranog iz Rothoblaas kataloga.....	191
Slika 40. Dijagrami unutarnjih sila na spoju između CLT ploče i čelične grede.....	196
Slika 41. Prikaz spojnog sredstva odabranog iz Rothoblaas kataloga.....	196

POPIS TABLICA

Tablica 1. Količine AB površina za zgradu A.....	201
Tablica 2. Količine CLT ploča d=200 mm za međukatne i krovne konstrukcije zgrade A.	201
Tablica 3. Količine CLT ploča d=140 mm za zidove zgrade A	203
Tablica 4. Količine stupova GL32h za zgradu A.....	204
Tablica 5. Količine AB površina za zgradu B	205
Tablica 6. Količine CLT ploča d=200 mm za međukatne i krovne konstrukcije zgrade B.	205
Tablica 7. Količine CLT ploča d=160 mm za međukatne i krovne konstrukcije zgrade B.	206
Tablica 8. Količine CLT ploča d=140 mm za zidove zgrade B	206
Tablica 9. Količine greda HE280A za zgradu B.....	207

PRILOZI

- Nacrt 001 – Tlocrt prizemlje (M 1:250)
- Nacrt 002 – Tlocrt 1. i 2. kata (M 1:250)
- Nacrt 003 – Tlocrt 3. kata (M 1:250)
- Nacrt 004 – Tlocrt 4. kata (M 1:250)
- Nacrt 005 – Tlocrt 5. kata (M 1:250)
- Nacrt 006 – Tlocrt 6. kata (M 1:250)
- Nacrt 007 – Tlocrt 7.-10. kata (M 1:250)
- Nacrt 008 – Presjek A-A (M 1:250)
- Nacrt 009 – Presjek B-B i presjek C-C (M 1:250)
- Nacrt 010 – Plan pozicija zidova prizemlja (M 1:200)
- Nacrt 011 – Plan pozicija zidova 1. i 2. kata (M 1:200)
- Nacrt 012 – Plan pozicija zidova 3. kata (M 1:200)
- Nacrt 013 – Plan pozicija zidova 4. kata (M 1:200)
- Nacrt 014 – Plan pozicija zidova 5. kata (M 1:200)
- Nacrt 015 – Plan pozicija zidova 6.-10. kata (M 1:200)
- Nacrt 016 – Plan pozicija ploče prizemlja do 3. kata (M 1:200)
- Nacrt 017 – Plan pozicija ploče 4. kata (M 1:200)
- Nacrt 018 – Plan pozicija ploče 5. kata (M 1:200)
- Nacrt 019 – Plan pozicija ploče 6. kata (M 1:200)
- Nacrt 020 – Plan pozicija ploče 7—10. kata (M 1:200)

Gulam_Marija_Diplomski_rad.pdf

ORIGINALITY REPORT

2%

SIMILARITY INDEX

2%

INTERNET SOURCES

1%

PUBLICATIONS

1%

STUDENT PAPERS

PRIMARY SOURCES

1

repozitorij.gradst.unist.hr

Internet Source

1%

2

adoc.pub

Internet Source

1%

3

Pierre Gehl, Darius M. Seyedi, John Douglas.
"Vector-valued fragility functions for seismic
risk evaluation", Bulletin of Earthquake
Engineering, 2012

Publication

<1%

Exclude quotes On

Exclude bibliography On

Exclude matches < 5 words